

NAVIENT Condensing System Boiler

Service Manual

Getting Service

If your boiler requires service, you have several options for getting service:

- Contact an official Technical Assistance Service (TAS) at 0344 332 2323 or go to the website (www.navien.co.uk).
For warranty service, always contact an official Technical Assistance Service (TAS) first.
- Contact the technician or professional who installed your boiler.
- Contact a Gas Safe Registered engineer.

When contacting an official Technical Assistance Service (TAS), please have the following information available:

- Model number
- Serial number
- Date purchased
- Installation location and type
- Error code, if any appears on the front panel display

Version: 1.1(March, 2025)

navien Condensing System Boiler

Service Manual

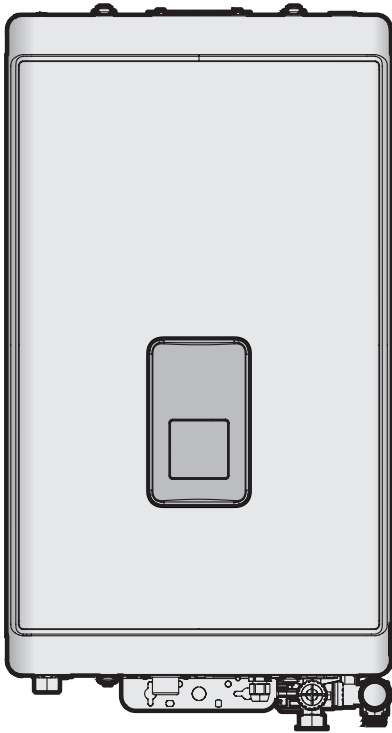

- These appliances are for use with natural gas or LPG. (An LPG conversion kit is included with the boiler.)
- Type: B23-C13-C33-C53-C83

Gas	Model	GC Number
Natural Gas	NCB500-15K System	41-709-09
	NCB500-18K System	41-709-10
	NCB500-24K System	41-709-11
	NCB500-30K System	41-709-12
LPG	NCB500-15K System	41-709-09
	NCB500-18K System	41-709-10
	NCB500-24K System	41-709-11
	NCB500-30K System	41-709-12

Keep this manual near this boiler for future reference whenever maintenance or service is required.

WARNING

If the information in these instructions is not followed exactly, a fire or explosion may result, causing property damage or personal injury.

- **Do not store or use petrol or other flammable vapours and liquids in the vicinity of this or any other appliance.**
- **WHAT TO DO IF YOU SMELL GAS**
 - Do not try to light any appliances.
 - Do not touch any electrical switch; do not use any phone in your building.
 - Immediately call the National Gas Emergency Helpline on (Freephone) 0800 111999 or your gas supplier from a neighbour's phone. Follow the instructions received.
- **Installation and service must be performed by a Gas Safe registered installer, service agency or the gas supplier.**

Contents

1. Safety Information	7		
2. Product Information	11		
2.1 Description of the Boiler	11		
2.2 Components	12		
3. Technical Data	14		
3.1 Technical Data	14		
3.2 Dimensions	17		
4. System Details	18		
4.1 Setting the DIP Switches	18		
4.1.1 PCB DIP Switches	18		
4.1.2 Front Panel DIP Switches	18		
4.2 Measuring the Inlet Gas Pressure	19		
4.3 Gas Conversion	20		
4.4 Using the Front Panel	25		
4.4.1 Icons and Digital Display	25		
4.4.2 Buttons	26		
4.4.3 Turning the Boiler On or Off	27		
4.4.4 Start-Up Wizard	27		
4.4.5 Gas Wizard	27		
4.4.6 Adjusting the Temperature	28		
4.4.7 Resetting the Boiler	29		
4.4.8 Accessing Basic Menu Items	29		
4.4.9 Accessing Advanced Menu Items	34		
4.5 Wiring Diagram	39		
4.6 Ladder Diagram	40		
4.7 Key Component Descriptions	41		
4.7.1 PCB	41		
4.7.2 High Temperature Limit Switch	42		
4.7.3 Thermistor	43		
4.7.4 Fan Motor	44		
4.7.5 Flame Rod Assembly	45		
4.7.6 Ignition Transformer	46		
4.7.7 Main Gas Valve	47		
4.7.8 Burner	48		
4.7.9 Primary Heat Exchanger	49		
4.7.10 Secondary Heat Exchanger	50		
4.7.11 Circulation Pump	51		
4.7.12 Water Pressure Sensor	52		
4.7.13 Expansion tank	53		
5. Troubleshooting	54		
5.1 Error Code Classification	54		
5.2 Error Code List and Actions	55		
5.2.1 Error 001	57		
5.2.2 Error 003	59		
5.2.3 Error 004	65		
5.2.4 Error 012	66		
5.2.5 Error 016	68		
5.2.6 Error 030	70		
5.2.7 Error 031	71		
5.2.8 Error 046	72		
5.2.9 Error 047	72		
5.2.10 Error 109	73		
5.2.11 Error 205	75		
5.2.12 Error 218	77		
5.2.13 Error 302	78		
5.2.14 Error 352	79		
5.2.15 Error 353	80		
5.2.16 Error 515	81		
5.2.17 Error 517	82		
5.2.18 Error 593	82		
5.2.19 Error 594	83		
5.2.20 Error 615	83		
5.2.21 Error 740	84		
5.2.22 Error 782	84		
5.3 Troubleshooting guide by symptom	85		
5.3.1 Noise	85		
5.3.2 Water Temperature Issue	86		
5.3.3 Circuit breaker operation	87		
6. Replacement of Parts	88		
6.1 Replacement Procedure	88		
6.2 Components Replacement Instructions	88		
6.2.1 PCB	88		
6.2.2 Fuse	89		
6.2.3 Fan Motor (Combustion Air)	90		
6.2.4 Flame Rod	91		
6.2.5 Ignition Transformer	91		
6.2.6 Main Gas Valve	92		
6.2.7 Condensate Trap	92		
6.2.8 Circulation Pump	93		
6.2.9 Water Pressure Sensor	93		
7. Components Diagram and Part List	94		
7.1 Case Assembly	94		
7.2 Combustion Assembly	96		
7.3 Waterway Assembly	99		
8. Inspection and Maintenance Schedule	100		
8.1 Annual Servicing	100		
8.2 Maintenance Report	100		
8.3 Maintenance Schedules	100		
8.4 Inspection Report	100		
8.5 Routine Servicing	101		
8.5.1 Interim Service	101		
8.5.2 Full Service	103		
8.5.3 CO and Combustion Checks	105		

Navien Warranty

Warranty Period

Navien products come with a limited warranty covering. The warranty covers labour, parts, and the heat exchanger. The warranty period starts from the date of original installation. The date of original installation must be advised to Navien, and if requested, proof of the original installation date must also be provided to Navien. When the product is installed in a new installation, the warranty period will start from the date the end-user takes responsibility for the property.

Product	Warranty Period
NCB500 Series Boiler (Residential use, single dwelling)	10 years

Warranty Claim Procedure

To obtain warranty repair service, the end user or homeowner must contact the original installer of the Navien product. If the original installer is unknown, the end user or homeowner can contact the Navien Technical Department at **0344-332-2323**. Proof of purchase is required to obtain warranty service.

Warranty Service

At its option, Navien will replace the defective component (part(s) or heat exchanger), in accordance with the terms of this Limited Warranty, if it fails in normal use and service during the Applicable Warranty Period identified above. The replacement component must be Navien original factory component. Navien, at its sole discretion, may replace the product with a new or refurbished product of comparable quality and design. The replacement component or product will be warranted only for the unexpired portion of the original component's Applicable Warranty Period. Payment for labour in completing the warranty service is subject to Navien's prior written approval and shall be subject to Navien's schedule of approved labour allowances.

Warranty Exclusions

Navien's Limited Warranty shall be void in the event of an occurrence of any of the following:

- Improper installation, failure to install in strict compliance with the Installation Manual procedures, installed by a non-licensed installer, and installation in violation of applicable rules, laws or building codes.
- Product purchased through the internet, other e-commerce channels, or any installer that obtained the Product from a supplier or distributor not authorised by Navien.
- Failure to perform regular maintenance, misuse, operation at settings other than those recommended or specified, non-compliance with instructions or guidelines set forth in the User's Operation Manual.
- Modification or alteration of the Product in any manner, including but not limited to, removal of any component or part, addition of any non-approved components, relocating or moving the Product from its original installation site, or any accidental or intentional damage to the Product.
- Installation in commercial or multi-unit dwelling applications or for non-recommended uses.
- Any damage caused by local adverse conditions including but not limited to hard water deposits, lime or mineral build-up, operating in corrosive atmospheric elements.
- Damage or caused by gas flow issues, electrical surges, flooding, fire, abnormal external temperature, and any other cause of damage not directly caused by a manufacturing defect.
- Installer's failure to fully comply with the Warranty Service and Return Policy procedures previously provided to Installer and as is available on Navien's website. Such policies include but are not limited to the Installer's failure to first contact Navien Technical Support while in front of the product for purposes of trouble shooting the identified problem or issue.
- Performance problems caused by improper sizing of the boiler, the gas supply line, the flue connection, combustion air openings, electric service voltage, wiring, fusing or any other components, parts or specifications.
- Improper conversion from natural gas to LP gas or LP gas to natural gas or attempt to operate with a type of gas not specified for the boiler.
- Any damage, malfunction or failure caused by abuse, negligence, alteration, accident, fire, flood, freezing, wind, lightning and other acts of God.
- Operating, using or storing the boiler in a corrosive or contaminated atmosphere or environment.
- Operating the boiler at water temperatures outside the factory calibrated temperature limits and/or exceeding the maximum setting of the high limit control.
- Operating the boiler when it is not supplied with potable water at all times.
- Subjecting the heat exchanger to pressures or firing rates greater or lesser than those shown on the rating plate.
- Removal or alteration of the rating plate.

Abbreviations and Definitions

Abbreviation	Definition
NCB500	General name for NCB500-2S/37K, NCB500-2S+/41K products
NG	Natural Gas
LP	Propane Gas
AP	Air Pressure
APS	Air Pressure Sensor
DHW	Domestic Hot Water
FM	Fan Motor
GARC	Gas Air Ratio Control
LPM	Litre Per Minute
MGV	Main Gas Valve
RPM	Revolutions per Minute
PCB	Printed Circuit Board
EMI	Electromagnetic Interference
HTL	High Temperature Limiter
LWCO	Low Water Cut Off

1. Safety Information

The following safety symbols are used in this manual. Read and follow all safety instructions in this manual precisely to avoid unsafe operating conditions, fire, explosion, property damage or personal injury.

DANGER

Indicates an imminently hazardous situation which, if not avoided, could result in severe injury or death.

WARNING

Indicates a potentially hazardous situation which, if not avoided, could result in injury or death.

CAUTION

Indicates a potentially hazardous situation which, if not avoided, could result in property damage.

DANGER



If you smell gas:

- Do not try to light any appliances.
- Do not touch any electrical switches or use landline phones.
- From a neighbour's phone, call your gas provider and follow their instructions.
- If you cannot reach your gas provider, call the fire department.
- Do not return to your home until authorised by your gas supplier or the fire department.

Do not use or store flammable products, such as petrol, solvents, or adhesives in the same room or area as the boiler.

- The boiler has a main burner flame that can turn on at any time and can ignite flammable vapours. Vapours from flammable liquids can explode and catch fire, causing severe burns.
- Vapours cannot be seen and are heavier than air. They can travel long distances along the ground and can be carried from other rooms to the boiler's main burner flame by air current.
- Keep all flammable products far away from the boiler and store them in approved containers. Keep the containers closed tightly and out of the reach of children and pets.

WARNING

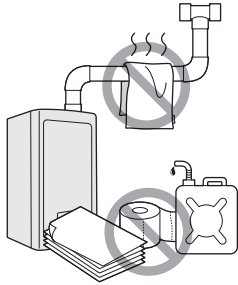

- **Do not store or use petrol or other flammable liquids near this boiler.**
Doing so may result in fire or explosion.
- **Do not place combustibles, such as newspapers or laundry, near the boiler or flue system.**
Doing so may result in a fire.
- **Do not place or use hair sprays, spray paints, or any other compressed gases near the boiler or flue system, including the flue termination.**
Doing so may result in fire or explosion.
- **Do not operate the boiler with the front cover opened.**
Doing so may result in fire or carbon monoxide (CO) poisoning, which may result in property damage or personal injury.
- **Do not operate this boiler without proper flue system.**
Doing so may result in fire or carbon monoxide (CO) poisoning, which may result in property damage or personal injury.
- **Do not touch the power cord or internal components of the boiler with wet hands.**
Doing so may result in electric shock.

WARNING

This appliance can be used by children aged from 8 years and above and persons with reduced physical, sensory or mental capabilities or lack of experience and knowledge if they have been given supervision or instruction concerning use of the appliance in a safe way and understand the hazards involved. Children shall not play with the appliance. Cleaning and user maintenance shall not be made by children without supervision.

⚠ CAUTION

- **Do not turn on the boiler unless the water and gas supplies are fully opened.**
Doing so may damage the boiler.
- **Do not turn on the water if the cold water supply shut-off valve is closed.**
Doing so may damage the boiler.
- **Do not use this boiler for anything other than its intended purpose, as described in this manual.**
- **Do not remove the front cover unless the power to the boiler is turned off or disconnected.**
Failure to do so may result in electric shock.
- **When servicing the controls, label all wires prior to disconnecting them.**
Failure to do so may result in wiring errors, which can lead to improper or dangerous operation. Verify proper operation after servicing.
- **Do not use unapproved replacement or accessory parts.**
Doing so may result in improper or dangerous operation and will void the manufacturer's warranty.
- **Do not place anything in or around the flue terminals, such as a clothes line, that could obstruct the air flow in or out of the boiler.**
- **This boiler has been approved for use in the UK and Ireland only.**
Using the boiler in any other country will void the manufacturer's warranty.

⚠ DANGER



To prevent burns:

- Use the lowest operating temperature setting necessary to provide comfortably hot water.
- If your household has children or elderly or disabled residents, consider using a lower temperature setting.
- Read all the instructions in this manual carefully before changing the temperature setting.
- Feel the water before using it on children, the elderly, or the disabled.

⚠ DANGER

This boiler's water temperature is set to 50°C at the factory for your safety and comfort. Increasing the temperature increases the risk of accidental scalding. Water temperatures at or above 52°C can cause instant scalding or severe burns. Before you decide to change the temperature setting, read the following charts carefully.

Water Temperature	Time in which a young child can suffer a full thickness (3rd degree) burn
70°C	Less than 1 second
60°C	1 second
55°C	10 seconds
49°C	10 minutes
37°C	Very low scald risk

General Installation Guidelines

Navien ensures that this product contains no harmful substances and that no harmful materials have been used in its manufacture.

Current legislation must be taken into account on installing this appliance, and it must be installed in a place with suitable ventilation.

The boiler must be installed by an installer authorised by the Ministry of Industry and it must be started up by an Official Technical Assistance Service authorised by Navien.

The requirements included in the following regulations must be observed on installing the boiler:

- The Gas Installation Regulation.
- The Technical Building Code.
- The Regulation for Heating Installations in Building.
- The Low Voltage Regulation.

Installation in hard water areas

- In areas with hard water (hardness exceeding 200 ppm), it is important to install a scale reducer.
The advice of the local water authority should be sought.

Installing the system piping

- The boiler is equipped with an internal relief valve. All systems must be capable of sustaining pressure of up to 3 bar.
- The air vent is required in the system during filling.

CAUTION

The boiler is equipped with an internal bypass valve. The internal bypass valve is not intended to replace an external bypass valve. An external automatic bypass valve is required if a zone valve has been connected to the system.

Gas Conversion

The boiler is configured for natural gas. If LPG conversion is required, use the conversion kit supplied with the boiler and attach the item matching the LPG GC No. (included in the kit).

The Codes of good practice and regulations refer to the latest versions of the same.

The installation must also comply with the following European Standards:

Standard	Description
UNE-EN 13831:2008	Closed expansion vessels with diaphragm.
UNE-EN 1856	Metal chimneys
UNE-EN 13384	Chimneys
UNE-EN 13779	Ventilation
UNE-EN ISO 16484	Building control systems.
UNE-EN 14336	Heating systems in buildings.
UNE-EN 15502-1	Gas-fired heating boilers Part 1: General Requirements and tests
UNE-EN 15502-2-1	Gas-fired heating boilers Part 2-1: Specific standard for type C appliances and type B2, B3 and B5 appliances of a nominal heat input not exceeding 1000 kW
UNE-EN 303-7:2008	Heating boilers.

UKCA/EC Conformity Declaration



Navien, hereby declares that the boiler models:

**NCB500-15K System, NCB500-18K System,
NCB500-24K System, NCB500-30K System**

to which this declaration refers, conform to and comply with the essential requirements of the following applicable European Standards and Directives.

Gas appliances: Regulation (EU) 2016/426
Standards EN15502-1, EN15502-2-1 and EN437

Boiler Efficiency: Directive 92/42/EEC
Regulation (EU) No.813/2013
Standards EN15502-1, EN15502-2-1

Low voltage: Directive 2014/35/EU and
Standards EN 60335-1, EN 60335-2-102

Electro-magnetic Compatibility: Directive 2014/30/EU
Standards EN 55014

Pressure Vessels: Directive 2014/68/EU

Navien, manufactures its products using a Quality Assurance system in compliance with Standard EN-ISO 9001:2015.

2. Product Information

2.1 Description of the Boiler

The Navien NCB500 boiler is available in 4 models: NCB500-15K System, NCB500-18K System, NCB500-24K System, NCB500-30K System

The main features are as follows:

- **Power Interruption:** When the power is restored after a power failure, the boiler will automatically start and return to normal operation. A manual reset is not required.
- **Freeze Protection:** A sensor inside the boiler automatically detects the temperature and, if necessary, initiates a safety heating cycle to prevent internal equipment damage due to freezing temperatures.
- **Short-Circuit Protection:** Any short-circuit occurring in the boiler's electrical circuit immediately blows the internal glass fuses and automatically cuts off the gas supply.
- **Lightning Protection:** Each boiler is specially grounded, both internally and externally, to protect against lightning strikes.
- **Carbon Monoxide Protection:** The boiler is designed to maintain a safe air-to-gas ratio and combustion rate. This function is continuously monitored by the boiler's air ratio control module.
- **Thermostat Control Failure:** Should the thermostat fail to function properly, the boiler's gas supply will be shut off automatically as a safeguard.
- **Auto Fan Detection:** The rotation of the fan is automatically detected and controlled. Fan failure will stop the operation of the boiler.
- **Boiling Prevention:** Excessive temperatures will automatically stop the boiler.

2.2 Components

The following diagram shows the key components of the boiler. Component assembly diagrams and particular parts lists are included in the Appendices.

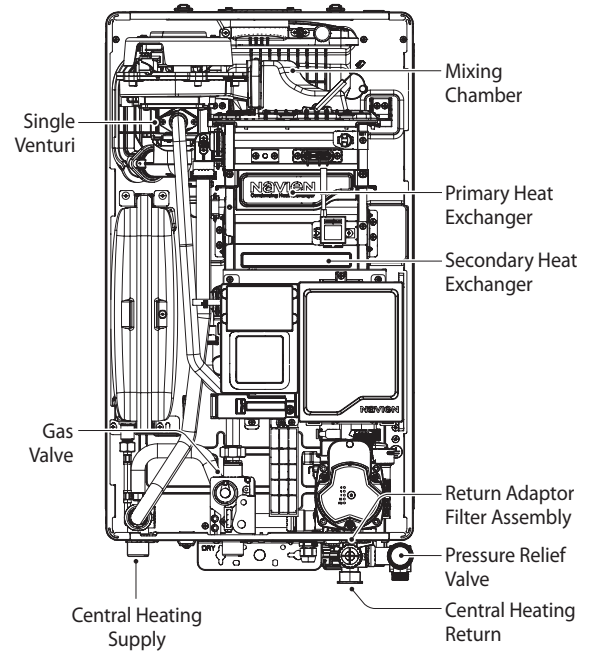
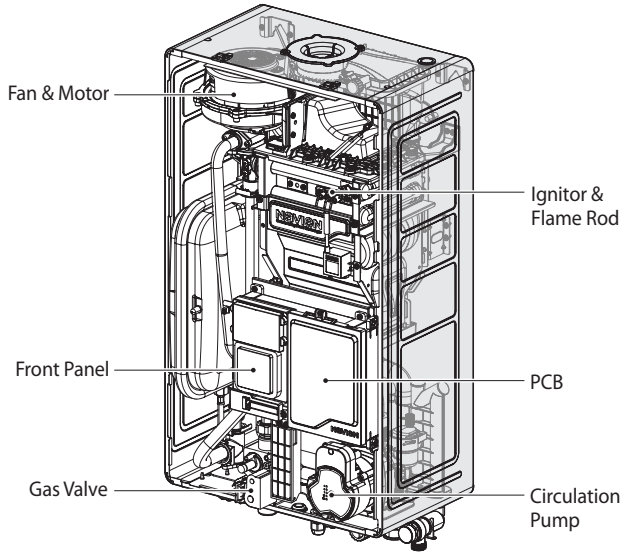

NCB500-15K System
NCB500-18K System

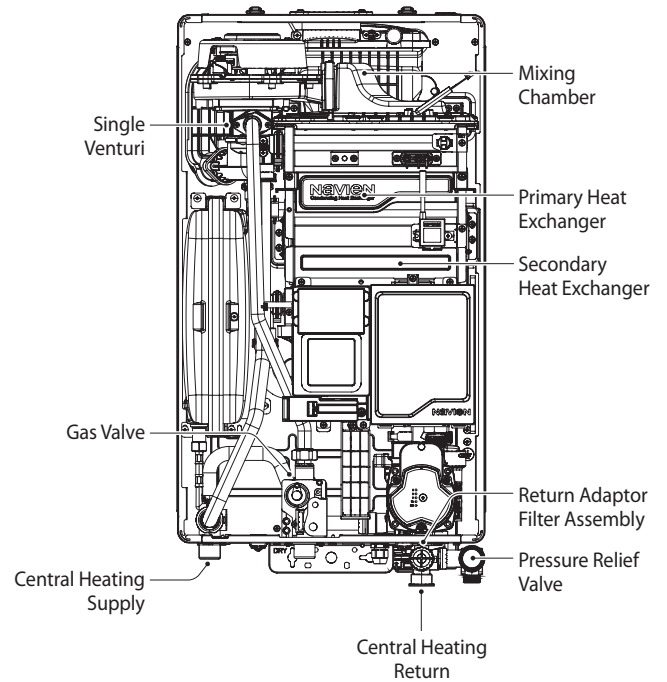
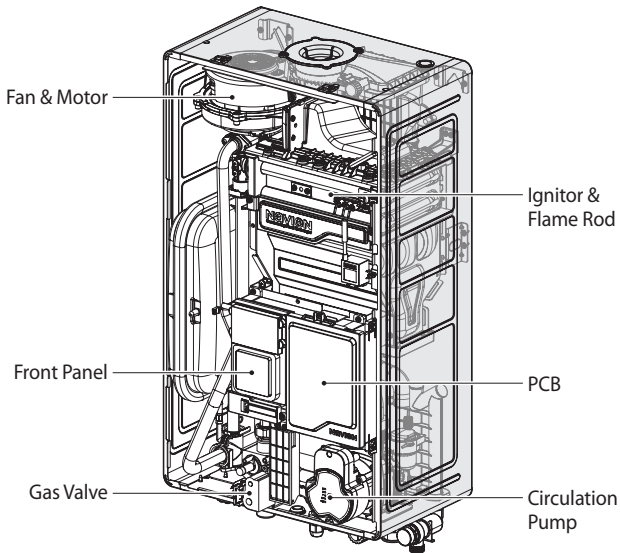

NCB500-24K System

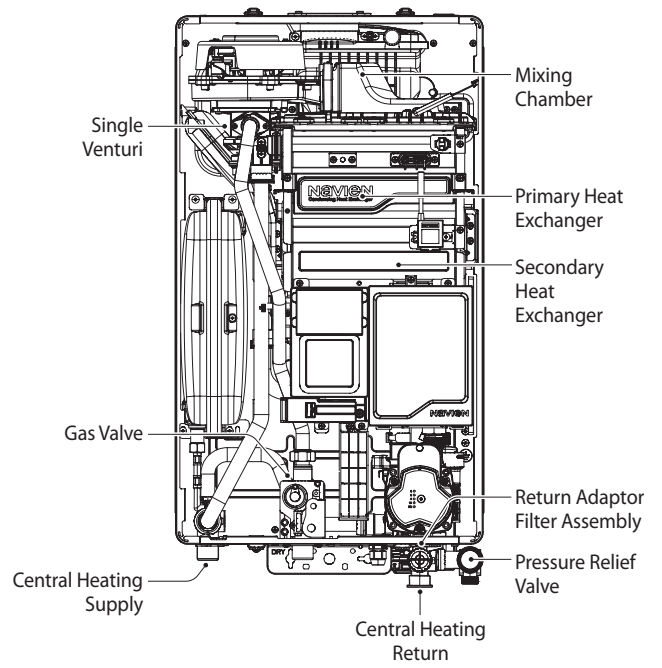
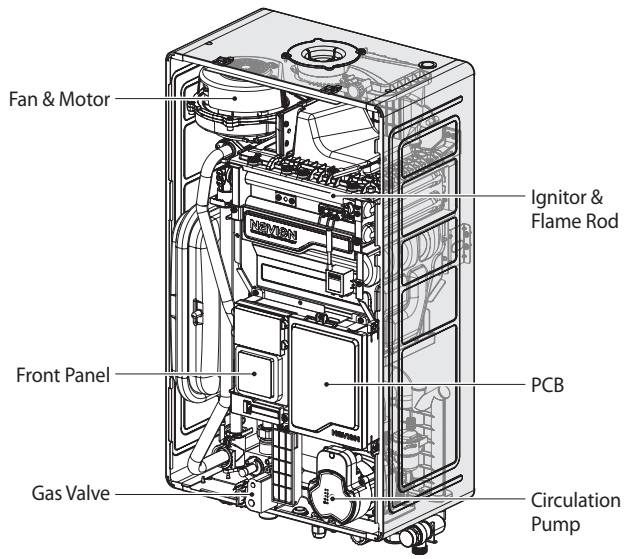

NCB500-30K System

3. Technical Data

3.1 Technical Data

The following table lists the general specifications for the boiler.

Specifications		Unit	NCB500-15K System	NCB500-18K System	NCB500-24K System	NCB500-30K System
Heat input range (Net)	Natural gas	kW	15.5/2.7	18.6/3.2	24.7/4.3	31.0/4.6
	20% H ₂ Blended gas	kW	14.7/2.6	17.6/3.1	23.2/4.3	29.3/4.4
Heat output range @ 80/60°C		kW	15.0/2.6	18.0/3.1	24.0/4.2	30.0/4.5
Condensing heat output range @ 50/30°C		kW	16.4/2.9	19.4/3.4	25.6/4.5	32.6/4.8
Full load efficiency at Max. output @ 80/60°C		%	87.3	88.1	88.4	86.8
Full load efficiency at Max. output @ 50/30°C (Condensing)		%	105.9	104.6	106.5	105.2
Partial load (30%) efficiency with 30°C return temp.		%	110.5	110.9	108.5	110.4
Seasonal efficiency rate (SEDBUK 2009)		-	89.6	89.8	88.9	89.5
Max. gas flow rate@ 15°C/1013mbar	Natural Gas	m ³ /h	1.64	1.97	2.61	3.28
	20% H ₂ , Blended gas	m ³ /h	1.81	2.17	2.88	3.61
NOx Classification		-	Class 6			
Category		-	II2HY203P			
Type		-	System			
Heat output adjustment		-	Adjustable over entire Max./Min. output range			
Type of heating installation		-	Close circuit			
Max. heating operation pressure		bar	2.5			
Max. heating temperature		°C	90			
Adjustable heating temperature range		°C	40-90			
Expansion vessel volume		L	6			
Expansion vessel pre-charged pressure		bar	1.0			
Electrical power supply		-	230V/50Hz			
Nominal current		A	0.6	0.6	0.6	0.6
Max. power consumption		W	115	115	115	115
Appliance protection rating		-	IPX4D			
Boiler mounting system type		-	Wall-mounted			
Flue exhaust/Air intake system types		-	B23-C13-C33-C53-C83			
Flue exhaust/Air intake system diameters		mm	Coaxial Ø60/100			
Max. gas pipe pressure drop		mbar	2.94	2.94	2.94	2.94

Specifications		Unit	NCB500-15K System	NCB500-18K System	NCB500-24K System	NCB500-30K System
Max. horizontal coaxial length Ø60/100		m	8			
Max. vertical coaxial length Ø60/100		m	8			
Equivalent elbow length @ 90° Ø60/100		m	1.3			
Equivalent elbow length @ 45° Ø60/100		m	1.0			
Hydraulic connection diameter	Central Heating	mm	22			
	Gas supply	mm	22			
Dimensions (Width x Depth x Height)		mm	395 x 283 x 680			
Total boiler weight (lift weight)		kg	27		29	32

The following table lists the product information requirements (EU regulation No 811/2013 and No 813/2013).

Specifications		Unit	NCB500-15K System	NCB500-18K System	NCB500-24K System	NCB500-30K System
Condensing boiler			YES	YES	YES	YES
Low-temperature (**) boiler			NO	NO	NO	NO
B1 boiler			NO	NO	NO	NO
Cogeneration space heater			NO	NO	NO	NO
Combination heater			NO	NO	NO	NO
Rated heat output	P_{rated}	kW	15	18	24	30
Seasonal central heating energy efficiency	η_s	%	93	93	93	93
Useful heat output						
At rated heat output and high-temperature regime (*)	P_4	kW	15.1	18.4	23.7	29.9
At 30 % of rated heat output and low-temperature regime (**)	P_1	kW	5.1	6.2	8.4	10.2
Useful efficiency						
At rated heat output and high-temperature regime (*)	η_4	%	87.7	87.7	88.3	87.4
At 30 % of rated heat output and low-temperature regime (**)	η_1	%	98.9	99.9	97.8	98.0
Auxiliary electricity consumption						
At full load	el_{max}	kW	0.036	0.047	0.039	0.039
At part load	el_{min}	kW	0.006	0.011	0.017	0.019
In standby mode	P_{SB}	kW	0.003	0.003	0.003	0.003
Other items						
Standby heat loss	P_{stby}	kW	0.127	0.127	0.078	0.127
Ignition burner power consumption	P_{ign}	kW	0	0	0	0
Annual energy consumption	Q_{HE}	GJ	27.5	33.1	43.2	53.7
Sound power level, indoors	L_{WA}	dB	51	55	52	51
Emissions of nitrogen oxides	NO_x	mg/kWh	49.6	41.6	32.9	52.9
Contact details	Navien LTD, Building 2, Guildford Business Park, Guildford, GU2 8XG					

(*) High-temperature regime means 60 °C return temperature at heater inlet and 80 °C feed temperature at heater outlet.

(**) Low temperature means for condensing boilers 30 °C, for low-temperature boilers 37 °C and for other heaters 50 °C return temperature (at heater inlet).

Specific precautions

Read the user's information and installation manual before the application is assembled, installed or maintained.

3.2 Dimensions

The following diagrams show the dimensions of the boiler and the table lists the supply connections.

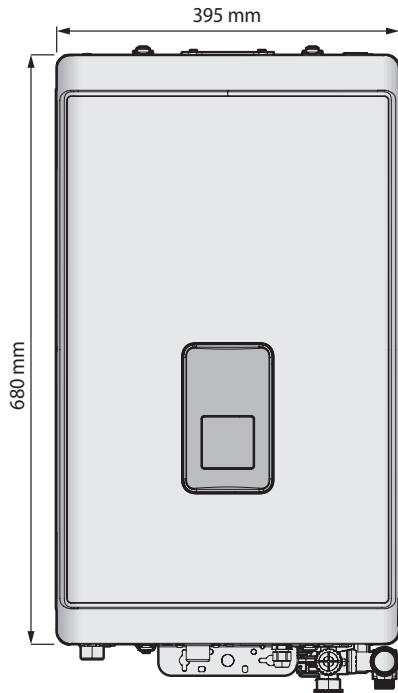

Supply Connections

	Description	Diameter
A	Flue exhaust/Air intake	Ø60/100
B	Central heating supply	22 mm
C	Gas supply inlet	22 mm
D	Central heating return	22 mm

Overhead View

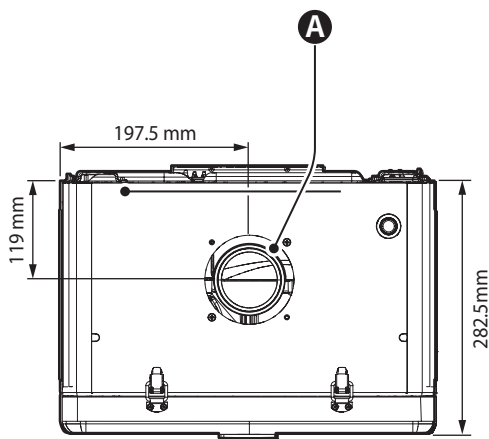

Bottom View

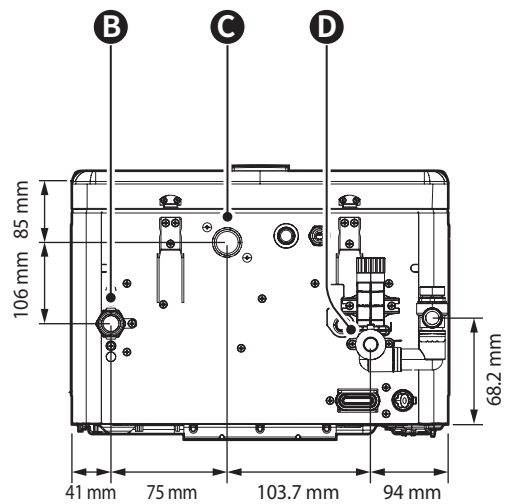

NCB500-15K System
 NCB500-18K System
 NCB500-24K System
 NCB500-30K System

4. System Details

4.1 Setting the DIP Switches

! CAUTION

Do not remove the front cover unless the power to the boiler is turned off or disconnected. Failure to do so may result in electric shock.

The boiler has 2 sets of DIP switches on the main circuit board (PCB) and 2 sets of DIP switches on the front panel. DIP switches are used to control the functionality of the boiler. Set the DIP switches appropriately, based on the installation environment.

4.1.1 PCB DIP Switches

Dip Switch (Set of 8)

The DIP SW 1 on the circuit board configures boiler type, capacity, burner type, country, and discharge of condensate function.

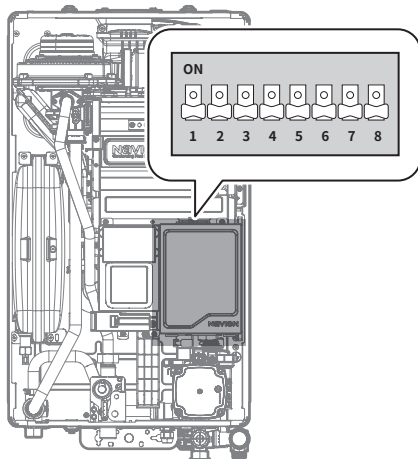

DIP SW1

Switch	Function	Setting	
1	Boiler Type	SYSTEM	ON
		COMBI	OFF
2&3&4	Capacity	15kW	2-OFF, 3-OFF, 4-OFF
		18kW	2-OFF, 3-ON, 4-OFF
		24kW	2-OFF, 3-OFF, 4-ON
		30kW	2-OFF, 3-ON, 4-ON
5&6	Country	UK	5-OFF, 6-OFF
		Not Used	5-ON, 6-OFF
		Not Used	5-OFF, 6-ON
		Not Used	5-ON, 6-ON
7&8	Boiler Model	NCB500	7-ON, 8-OFF

DIP SW2

Switch	Function	Setting	
1	Reserve		
3	Reserve		
4	Reserve		
5&6	Country		

4.1.2 Front Panel DIP Switches

Dip Switch (Set of 2)

The DIP SW on the front panel configures the fuel selection.

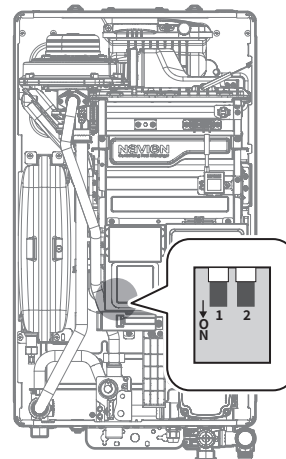

Switch	Function	Setting	
1 & 2	Fuel selection	LNG (G20)	1-OFF, 2-OFF
		Not Used	1-OFF, 2-ON
		LPG (G30)	1-ON, 2-OFF
		Not in UK	1-ON, 2-OFF
		LPG (G31)	1-ON, 2-ON

4.2 Measuring the Inlet Gas Pressure

WARNING

The boiler cannot function properly without sufficient inlet gas pressure. Measuring the inlet gas pressure should be performed by a licensed professional only.

Natural Gas Connection

- The gas supply must comply to the current Gas Safety (Installation and Use) Regulations, in accordance with BS 6891.
- The nominal inlet working gas pressure measured at the appliance should be 21 mbar +/- 2 mbar for Natural gas (G20). Allowing for the acceptable pressure loss of 1 mbar across the installation pipework, it can be assumed that a minimum permitted operating pressure of 18 mbar will be delivered to the inlet of the appliance. (Reference BS 6400-1 Clause 6.2 Pressure Absorption).
- When tested at the gas valve, the pressure drop from the meter to the gas valve must not be more than 3 mbar.

Propane Gas Connection (LPG)

- For use with propane gas, the LPG conversion kit has to be installed, see separate conversion instructions.
- The LPG installation must comply to the current Gas Safety (Installation and Use) Regulations, in accordance with BS 6891.
- Installing of a LPG installation should only be done by a registered LPG installer.
- The tank must be provided with a high pressure regulator with a minimum capacity of 24 kg/h to reduce the tank pressure from 5 to 1.5 bar. The 1.5 bar high pressure gas line should have a minimum diameter of 15 mm. In the high pressure gas line a house pressure regulator must be installed.
- When tested at the gas valve, the pressure drop from the pressure regulator to the gas valve must not be more than 2 mbar.
- Each gas appliance which is connected to the propane installation must be provided with its own house pressure regulator. The house pressure regulator is a third party part. The house pressure regulator must have a minimum capacity of 10 kg/h/37 mbar and a CE certification.

To measure the inlet gas pressure:

1. Shut off the manual gas valve on the gas supply line pipe.

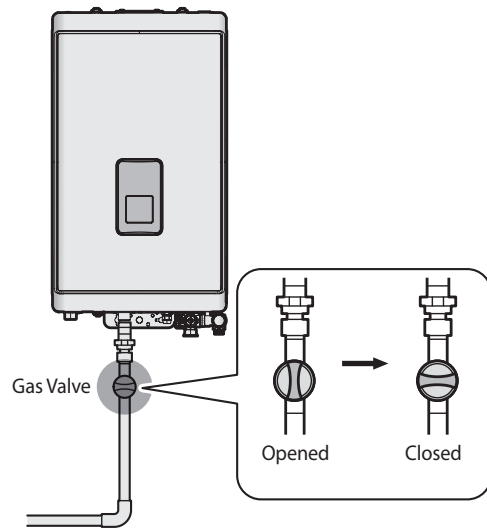

2. Open a hot water tap. The boiler should turn on and the gas in the gas supply line will be purged.
3. Leave the tap on until the boiler shuts down due to a lack of gas supply, and then turn off the hot water tap.
4. Unfasten the 2 latches (at the top) and remove 2 screws (at the bottom) to remove the front cover and gain access to the internal components.

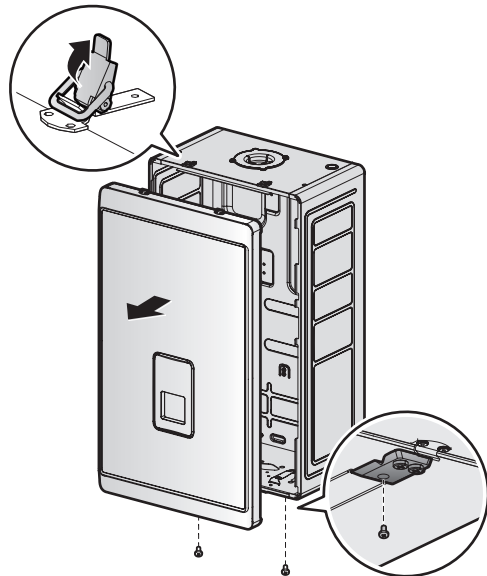

CAUTION

Ensure that no cables are in the way before folding down the PCB assembly. If the assembly is stuck, do not force it. Doing so may damage the cables and result in serious malfunctions. Check again to ensure that no cables or any other parts are in the way before you proceed.

- Loosen the screws indicated in the figure below and connect a manometer to the pressure port. Reset the manometer to zero before use.

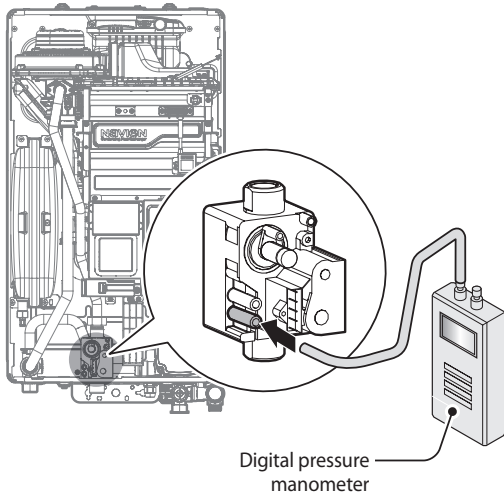

- Re-open the manual gas valve and check for leaks.
- Open multiple fixtures that have high flow rates, such as bathtub and shower taps, to ramp the boiler up to its maximum firing rate.
- When the boiler reaches its maximum firing rate, check the inlet gas pressure reading on the manometer. The gas pressure must fall within the ranges specified in the table below.

Gas	Normal (mbar)	Minimum (mbar)	Maximum (mbar)
Natural Gas	20	17	30
LPG	37	25	45

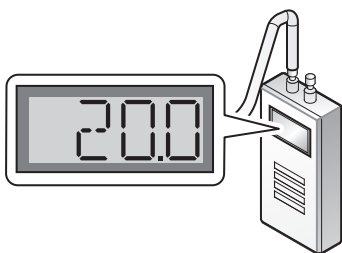

4.3 Gas Conversion

This boiler is configured for Natural Gas at the factory. If conversion to Propane Gas is required, use the conversion kit supplied with the boiler.

WARNING

This conversion kit must be installed by a qualified service agency* in accordance with all applicable codes and requirements of the authority having jurisdiction. The information in these instructions must be followed to minimise the risk of fire or explosion or to prevent property damage or personal injury. The qualified service agency is responsible for the proper installation of this kit. The installation is not proper and complete until the operation of the converted appliance is checked as specified in the manufacturer's instructions supplied with the kit.

* A qualified service agency is any individual, firm, corporation or company which either in person or through a representative is engaged in and is responsible for the connection, utilization, repair or servicing of gas utilization equipment or accessories; who is experienced in such work, familiar with all precautions required, and has complied with all of the requirements of the authority having jurisdiction.

Tools Required:

- Phillips Screwdriver
- Flathead Screwdriver
- T15 Hexalobular Wrench
- Combustion Analyser or Dual Port Manometer
- Gas Leak Detector

Included Items:

- Gas Orifice (refer to below table)

Model	G20	G31
NCB500-15K System	Ø4.35	Ø3.6
NCB500-18K System	Ø4.9	Ø3.95
NCB500-24K System	Ø5.95	Ø4.75
NCB500-30K System	Ø6.35	Ø5.05

Table 1. Orifice Size

- Gas Pressure and Conversion Kit Number Labels

Procedure:

1. Turn off both gas and water supply to the boiler.
2. Unfasten the 2 latches (at the top) and remove 2 screws (at the bottom) to remove the front cover to gain access to the internal components. See Figure 1 for illustration of the front cover on the unit.

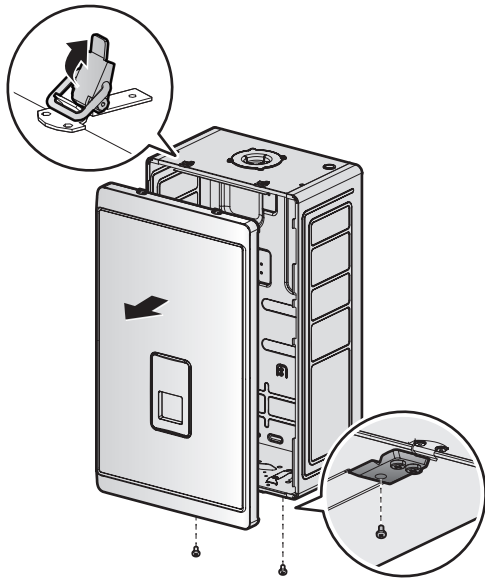
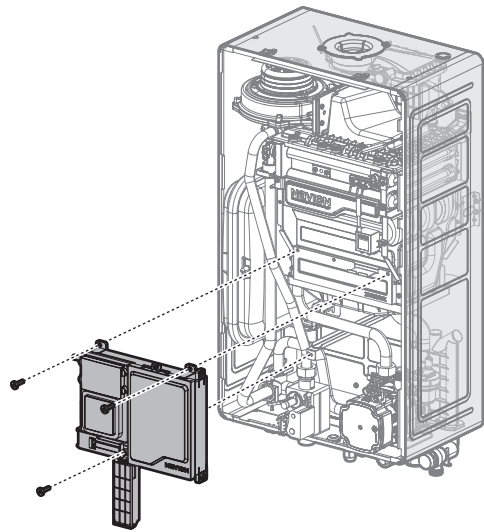

Figure 1. NCB500 Series Front cover

3. Remove the front cover and place it in a safe location to prevent accidental damage.
4. Label all the wires on the PCB.
5. Disconnect all the wires.

6. Loosen the three screws holding the front panel and remove the front panel.



7. With the internal components exposed, locate the gas inlet pipe and the gas valve in the middle of the unit, as shown in Figure 2.

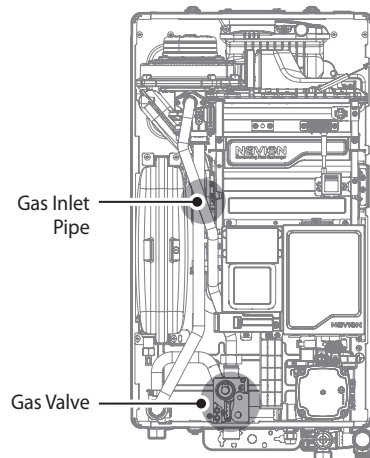

Figure 2. NCB500 Internal Components

8. Loosen the hex nut at location A - the connection above the gas valve where it connects to the pipe. See Figure 3 for reference. Once the hex nut is loose, carefully separate the pipe from the gas valve.

- Once the gas inlet pipe is detached from the gas valve, find location B - the connection above the gas valve where it is attached to the fan motor assembly. Carefully remove the two screws by hand using a Phillips screwdriver and pull the gas inlet pipe away from the fan assembly to access the gas orifice.

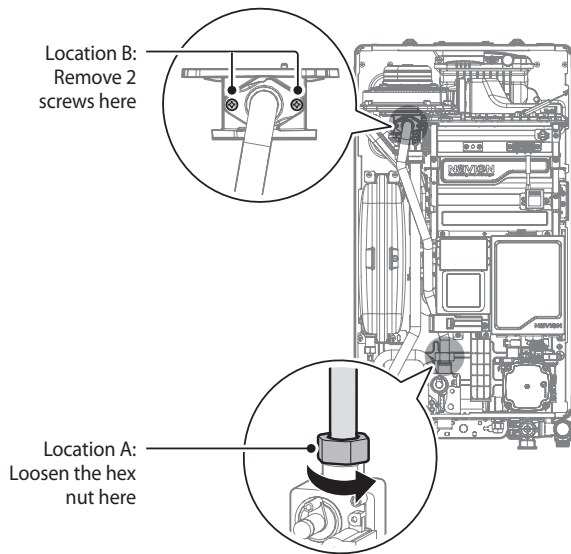

Figure 3. Detaching Gas Inlet Pipe from Gas Valve and Fan Motor Assembly

Once the Gas Orifice is exposed, remove the two screws that hold the part in place. Remove the Gas Orifice from its housing and prepare the new Gas Orifice for the LP conversion for installation.

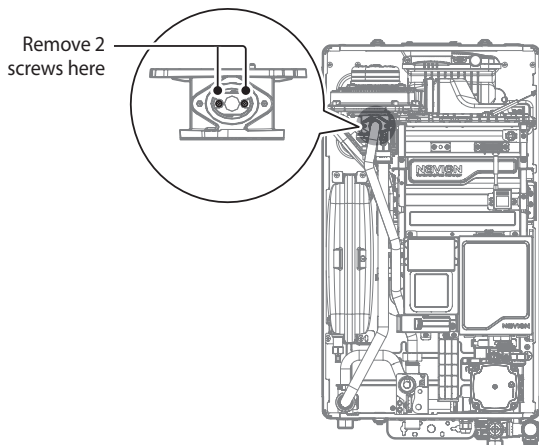

Figure 4. Access to Gas Orifice in Fan Assembly

! DANGER

A high voltage in the Fan Motor Assembly may cause an electrical shock resulting in severe injury or death.

! WARNING

- Do not adjust or attempt to measure gas valve outlet pressure. The gas valve is factory-set for the correct outlet pressure. This setting is suitable for natural gas and propane, requiring no field adjustment.
- Attempting to alter or measure the gas valve outlet pressure could result in damage to the valve, causing potential severe personal injury or substantial property damage. Navien NCB500 boilers are shipped ready to fire natural gas only.

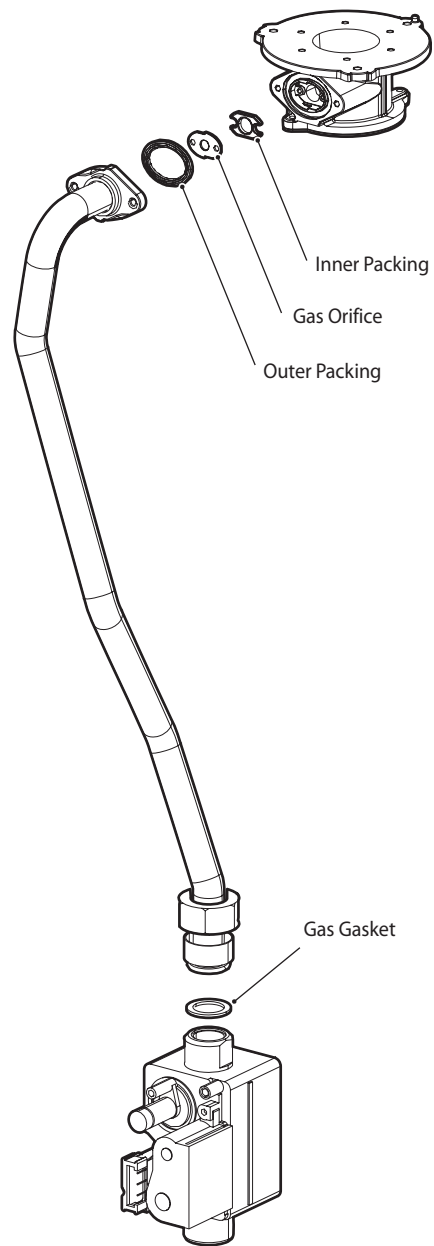

Figure 5. Exploded View of Gas Pipe Assembly (NCB500)

! DANGER

See Figure 5. Inspect the Outer packing between the venturi and gas valve inlet adaptor whenever they are disassembled. The Outer packing must be in good condition and must be installed. Failure to comply will cause a gas leak, resulting in severe personal injury.

Replace the old Orifice piece with the new part for use with LP gas. Ensure that the Orifice is properly seated inside the port before proceeding to the next step.

10. Replace the gas inlet pipe to its original position and use all screws to secure all connections.

Note Do not overtighten as this may damage or crack the components.

11. Check the labels carefully and then connect all the wires.

12. Set the front panel DIP Switch to change the gas type.

! WARNING

Ensure that you have turned off the power to the boiler before accessing the DIP switches.

Switch	Function	Setting	
1 & 2	Fuel Selection	G20 (LNG)	1-OFF, 2-OFF
		G30 (LPG) Not in UK	1-ON, 2-OFF
		G31 (LPG)	1-ON, 2-ON

Table 1. The DIP Switch Setting by Fuel Selection

! DANGER

- When conversion is required, be sure to set the front panel DIP switches according to the supply gas type.
- Failure to properly set the DIP switches could cause carbon monoxide poisoning, resulting in severe personal injury.

13. Turn on the gas and water supply to the boiler.

14. Measure and adjust the gas/air ratio.

- Loosen the screw, rotate the plate and remove the gasket to access the emissions monitoring port as shown in Figure 7.
- Insert the analyser into the port (Figure 7).

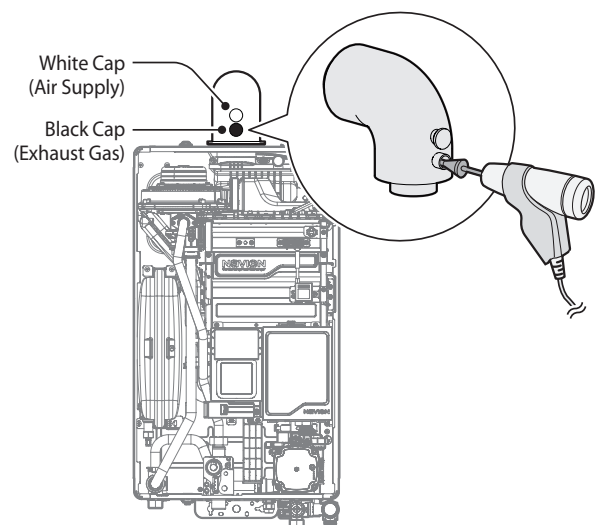

Figure 7. Insert the Analyser

Model	Gas Type	Max	Min
		%CO ₂	%CO ₂
NCB500	G20	8.8%	8.65%
	G31	10.25%	10.1%

Table 2. CO₂ Value

(CO₂ values for high fire must be within 0.5% and CO₂ values for low fire must be within 0.3% of the values listed.)

- c. Fully open several hot water fixtures and set the boiler to operate at 1-stage MIN mode.

Note For operation mode selection, refer to “4.4.9.5 Setting the Special Operation Modes” on page 38.

Measure the CO₂ value at low fire. If the CO₂ value is not within 0.5% of the value listed in Table 2, the gas valve set screw will need to be adjusted. If adjustment is necessary, locate the set screw as shown in Figure 8. Using a T15 Hexalobular wrench, turn the set screw no more than ¼ turn clockwise to raise or counterclockwise to lower the CO₂ value.

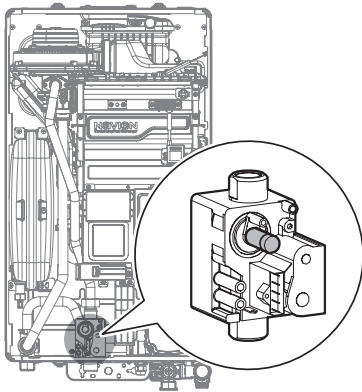

Figure 8. Set Screw Location

Note The set screw is located behind the screw-on cover. This must be removed first.

- d. After Gas Setup Wizard is done, operate at minimum mode.

Note For operation mode selection, refer to “4.4.9.5 Setting the Special Operation Modes” on page 38.

- e. Fully open several hot water fixtures and set the boiler to operate at CH MAX mode (refer to “4.4.9.5 Setting the Special Operation Modes” on page 38). Measure the CO₂ value at high fire. If the CO₂ values do not match Table 2 at high fire, do not adjust the gas valve. Check for the proper Gas Orifice.

! DANGER

Improper gas valve settings can cause severe personal injury or substantial property damage.

Model	Max. Input (Net. kW)	G20	G20 H ₂ 20% Blend
		Gas Flow Rate (m ³ /h)	Gas Flow Rate (m ³ /h)
NCB500-15 System	15.5	1.64	1.81
NCB500-18 System	18.6	1.97	2.17
NCB500-24 System	24.7	2.61	2.88
NCB500-30 System	31	3.28	3.61







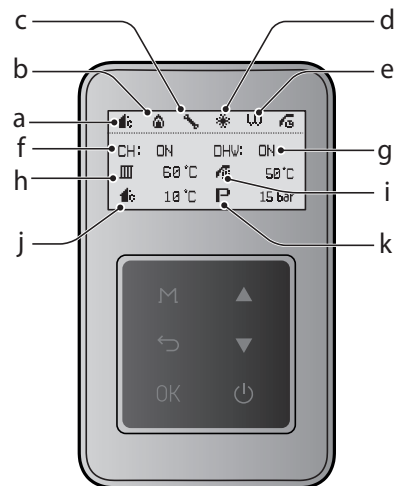

4.4 Using the Front Panel

The front panel allows you to adjust the temperature and view the operating status or error codes. Remove the protective sheet from the front panel before using it.

4.4.1 Icons and Digital Display

The icons and digital display on the front panel provide important information required for the boiler's operation. Refer to the following table for detailed information.



a		<p>Outdoor Temperature Control (OTC) Displayed when the Outdoor Temperature Control (OTC) is enabled.</p>	b		<p>Combustion Displayed when the burner is combusting.</p>
c		<p>System fault Displayed when a system fault is detected.</p>	d		<p>Anti-freeze Displayed when the boiler is operating in anti-freeze mode.</p>
e		<p>Schedule programming mode Displayed when the boiler's schedule programming operation is set.</p>	f	CH: ON	<p>Central heating demand Indicates the central heating demand is present.</p>
g	DHW: ON	<p>DHW demand Indicates that DHW demand is present.</p>	h		<p>Central heating set temperature</p> <ul style="list-style-type: none"> When the central heating temperature is set: <ul style="list-style-type: none"> - Displays the currently set central heating temperature. When the central heating temperature is not set: <ul style="list-style-type: none"> - Displays the current supply water temperature.
i		<p>DHW set temperature</p> <ul style="list-style-type: none"> When the DHW temperature is set: <ul style="list-style-type: none"> - Displays the currently set DHW temperature. When the DHW temperature is not set: <ul style="list-style-type: none"> - Displays the current supply water temperature when using the DHW thermostat. - Displays the current DHW tank temperature when using the Cylinder sensor. - Displays the current supply water temperature when controlled with Aquastat. 	j		<p>Outdoor temperature Displays the outdoor temperature.</p>
k			k		<p>System pressure Displays the internal water pressure of the boiler system.</p>

4.4.2 Buttons

Using the buttons on the front panel, you can turn on or off the boiler, monitor the current operation status, and set the values required for the boiler's operation, such as central heating and DHW supply temperatures. Refer to the following table for detailed information.

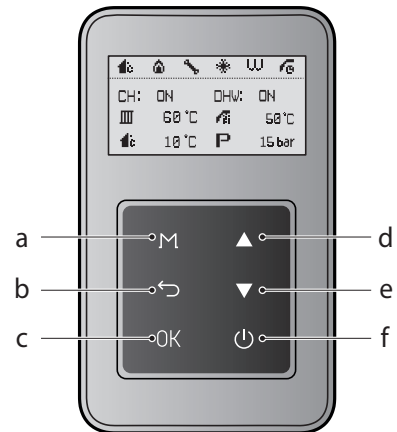

a		Menu button Access to the Main menu screen.	b		Back button Access to the previous screen.
c		OK button Access to the selected item.	d		Up button Increases the temperature setting, parameter or moves up.
e		Down button Decreases the temperature setting, parameter or moves down.	f		Power button Turns the boiler on or off.

4.4.3 Turning the Boiler On or Off

To turn the boiler on or off, press the Power button (⏻).

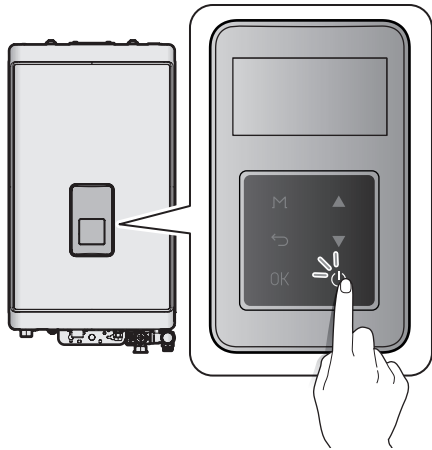

When the power is turned on for the first time, you must complete the start-up wizard. The temperature will appear on the front panel display after the power is turned on.

4.4.4 Start-Up Wizard

The setup wizard should run the first time the unit is powered on. The wizard must be completed before the boiler can be used.

1. Set the time.
 - YYYY:MM:HH:MM:SS
2. Check the gas type.
 - Natural Gas (G20)
 - Natural Gas (G25_G27) (not available)
 - Propane (G30) (not available)
 - Propane (G31)
3. Select the Heat Demand.
 - Smart Plus (Navien)
 - Panel
 - Switched Live
 - CH Thermostat
 - OpenTherm
4. Select the Cylinder Controls
 - Cylinder Stat
 - Cylinder Sensor
 - Wiring Center (Navien)
 - No Cylinder Control
5. Set the DHW Priority Time (available when Cylinder Stat or Cylinder Sensor is selected for Cylinder Controls).
 - Setting range: 0–180 min

6. Set the Anti-Legionella.
 - Setting range: Disable/Enable
7. Once the Setup Wizard is finished, a summary of the settings will be displayed. Press the OK button (OK) at each summary screen until the main screen is displayed. Settings made in the Setup Wizard can be adjusted from the Main Menu and Installer Menu as described in Section 4.4.8 and 4.4.9.

4.4.5 Gas Wizard

The error code E788 will appear if you try to change the gas type on the front panel. To change the gas type:

1. Press the Back button (←) on the error screen.

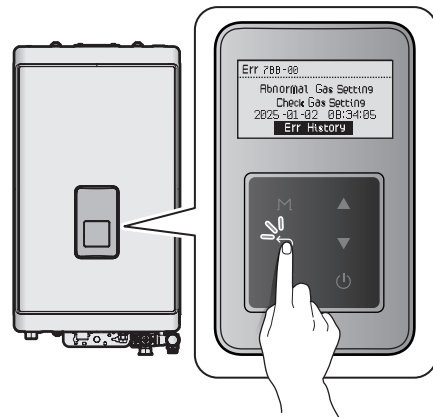

2. Set the desired gas type on the Gas Type Selection screen.

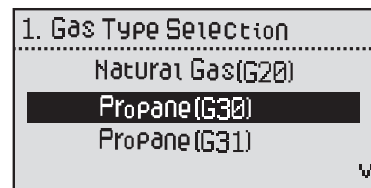

4.4.6 Adjusting the Temperature

4.4.6.1 Adjusting the Central Heating Temperature

To adjust the central heating temperature:

1. In normal operation mode, press the Down button (▼). The central heating temperature (■) is highlighted on the screen.

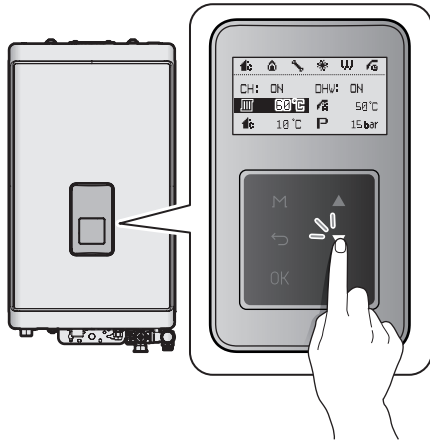

2. Press the OK button (OK) to select the central heating temperature (■). The highlighted section will flash.

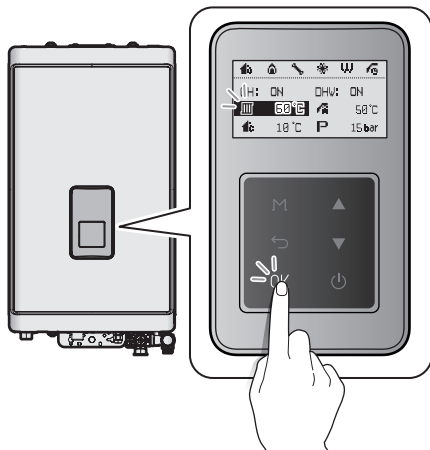

3. Press the Up button (▲) or the Down button (▼) until the desired temperature appears on the display. You can adjust the temperature while the display is flashing. Once the display stops flashing, the temperature setting is stored.

Note

- Take note of the original heating temperature in case you want to restore it to the default.
- The default central heating supply water temperature range is 40°C (Absolute MIN) to 90°C (Absolute MAX).
- The default central heating return water temperature range is 30°C (Absolute MIN) to 65°C (Absolute MAX).
- The central heating temperature cannot be adjusted when the Outdoor Temperature Control (OTC) is used.
- The central heating temperature cannot be adjusted, when the Heat Demand function is set to OpenTherm.

4.4.6.2 Adjusting the DHW Temperature (TANK SENSOR)



WARNING

Before adjusting the water temperature, carefully read "To prevent burns:" on page 9. Water above 52°C can cause instant scalding or severe burns.

To adjust the water temperature:

1. Make sure that all hot water taps are closed, and ensure that the internal circulator is off.
2. In normal operation mode, press the Up button (▲) The DHW temperature (■) is highlighted on the screen.

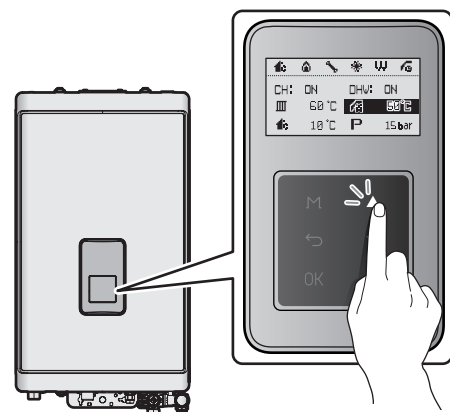

- Press the OK button (OK) to select the DHW temperature (65°C). The highlighted section will flash.

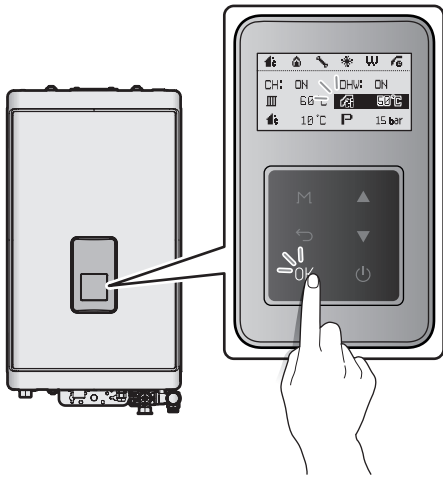

- Press the Up button (▲) or the Down button (▼) until the desired temperature appears on the display. You can adjust the temperature while the display is flashing. Once the display stops flashing, the temperature setting is stored.

Note

- Take note of the original water temperature in case you want to restore it to the default.
- The default DHW temperature range (TANK SENSOR) is 30°C to 65°C.
- The boiler will retain your settings during a power outage.
- The DHW temperature cannot be adjusted, when the Heat Demand function is set to OpenTherm.

4.4.7 Resetting the Boiler

If an error message appears, you can try resetting the boiler to resolve the problem. To reset the boiler, press the Back button (←).

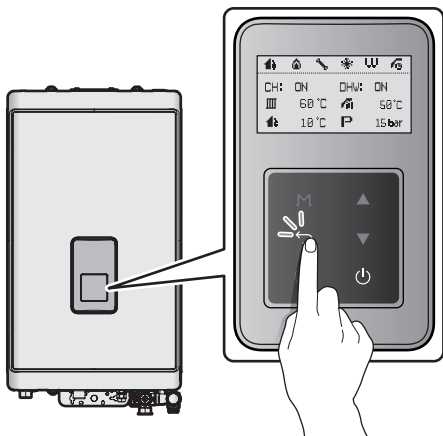

If resetting the boiler does not solve the problem, refer to the Troubleshooting section of this manual or contact a Technical Assistance Service.

4.4.8 Accessing Basic Menu Items

In the Main Menu screen, you can view the boiler's operating conditions, configure the central heating and DHW temperatures, and review error history. Press the Menu button (M) to enter the Main Menu screen.

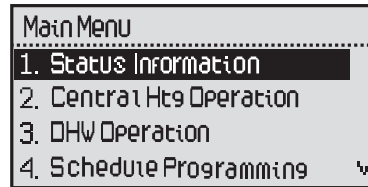

4.4.8.1 Viewing Basic Information

To view information about the boiler, press the Menu button (M), and then select "1. Status Information".

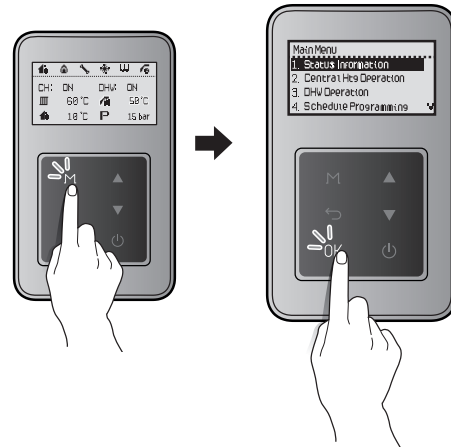

Press the Up button (▲) or the Down button (▼) to switch between the information items. Press the OK button (OK) to select an item and view the information.

Press the Back button (←) to exit information view mode.

Item	Description
1. Operation State	Current Operation State
2. Heat Capacity	Heat capacity (%)
3. CH Set Temp	Central heating set temperature (°C)
4. DHW Set Temp	DHW set temperature (°C)
5. Supply Temp	Heating supply temperature (°C)
6. Return Temp	Boiler return temperature (°C)
7. DHW Temp	External tank sensor temperature (°C)

Item	Description
8. Water Pressure	Water pressure (bar)
9. Flame Value	Flame detector AD value <ul style="list-style-type: none"> Flame On: 8bit AD values equal to or lower than 70 Flame Off: 8bit AD values equal to or higher than 175
10. Fan Target RPM	Fan target speed (RPM)
11. Fan Current RPM	Fan speed (RPM)
12. Exhaust Temp	Exhaust temperature (°C)
13. OTC ON/OFF	OTC status (Enabled/Disable)
14. K-Factor Set Value	K-Factor set value
15. Boiler	Boiler model
16. Model	Boiler output range
17. Type	Boiler type (System)
18. Gas	Fuel Type (LNG G20/LPG G31)
19. Main F/W Ver	Main firmware version
20. Panel F/W Ver	Panel firmware version

Note The fan motor controls the APS, so the fan target speed (Fan Target RPM) is only for your reference.

4.4.8.2 Setting the Central Heating Operation

To set the boiler's central heating operation, press the Menu button (M), and then select "2. CH Operation".

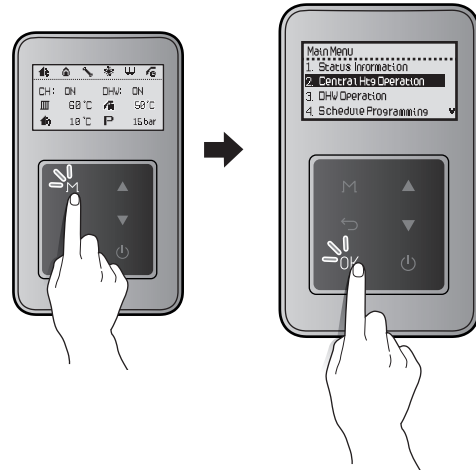

Press the Up button (▲) or the Down button (▼) to switch between the list items or to increase/decrease setting values. Press the OK button (O) to select an item or to confirm after making changes.

Press the Back button (↶) to return to the previous screen or menu.

Item	Description
1. CH ON/ OFF	Enable or disable central heating operation. <ul style="list-style-type: none"> Setting range: Enable/Disable Default: Enable
1-1 CH Set Temp	Set the central heating target temperature (°C) <ul style="list-style-type: none"> Setting range for central heating supply water: 40°C (Absolute MIN) – 90°C (Absolute MAX) Default for central heating supply water: 85°C Setting range for central heating return water: 30°C (Absolute MIN) – 65°C (Absolute MAX) Default for central heating return water: 65°C <p>This option is available only when "1. CH ON/OFF" is set to "Enable".</p>
2. OTC ON/OFF	Enable or disable the outdoor temperature control option.
2-1 K-Factor*	K-Factor for the central heating

Item	Description										
3. WWSD Temp	Set the Warm Weather Shut-down temperature. <ul style="list-style-type: none"> Setting range: 10°C – 40°C Default: OFF 										
4. WWSD On Diff	Set the differential temperature to deactivate the Warm Weather Shutdown. <ul style="list-style-type: none"> Setting range: 1°C – 20°C Default: 3°C 										
5. CH Control	Select the heating control type. <ul style="list-style-type: none"> 1: Supply Temperature 2: Return Temperature Default: Supply Temperature 										
6. CH Heat Demand	Set the heat demand control type for Smart Plus (Navien), Panel, Switched Live, CH. <ul style="list-style-type: none"> Default: Smart Plus (Navien) 										
7. CH Schedule	Set the central heating weekly timer. <p>Note To select this option, you must set up the Time settings in the Configuration menu.</p> <p>If you select an item, you can select the certain day to schedule the central heating modes.</p> <p>Note The schedule settings and checking function cannot be used when the Heat Demand function is set to Navien Thermostat.</p> <table border="1"> <thead> <tr> <th>Item</th> <th>Description</th> </tr> </thead> <tbody> <tr> <td>1. 7 Day</td> <td>Schedule a command for each day of the week.</td> </tr> <tr> <td>2. 5 + 2 Day</td> <td>Schedule a command for weekday and weekend.</td> </tr> <tr> <td>3. 5 + 1 + 1 Day</td> <td>Schedule a command for weekdays, Saturdays, and Sundays.</td> </tr> <tr> <td>4. OFF (Not Used)</td> <td>Disable the schedule function.</td> </tr> </tbody> </table>	Item	Description	1. 7 Day	Schedule a command for each day of the week.	2. 5 + 2 Day	Schedule a command for weekday and weekend.	3. 5 + 1 + 1 Day	Schedule a command for weekdays, Saturdays, and Sundays.	4. OFF (Not Used)	Disable the schedule function.
Item	Description										
1. 7 Day	Schedule a command for each day of the week.										
2. 5 + 2 Day	Schedule a command for weekday and weekend.										
3. 5 + 1 + 1 Day	Schedule a command for weekdays, Saturdays, and Sundays.										
4. OFF (Not Used)	Disable the schedule function.										

* When the boiler is connected to an outdoor temperature sensor (optional), functioning may be activated according to outdoor temperature conditions and K-factor values using the parameters.

The graph shows how the set temperature is determined. K-factor values can be set using the front panel.

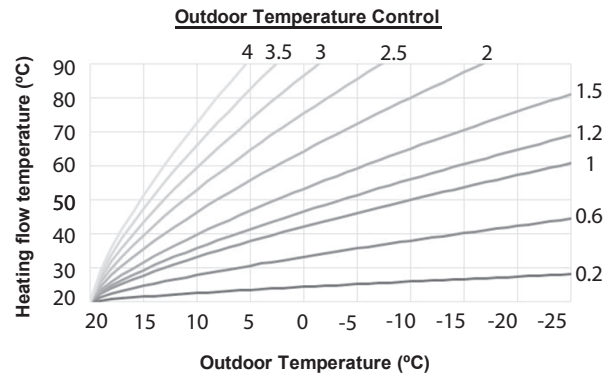

If there is an input from the outdoor temperature sensor, OTC (Outdoor Temperature Control) control will be enabled automatically. Also, if there is no input from the outdoor temperature sensor, OTC control will be disabled automatically.

Setting the Schedule

When setting up the option, select '7 Day,' and select between Mon, Tue, Wed, Thu, Fri, Sat, Sun to go to the Schedule menu.

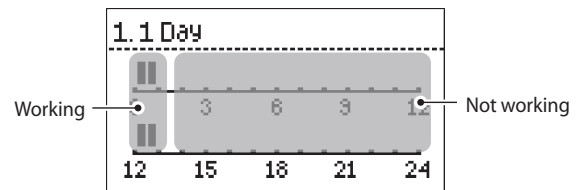

Press the Up button (▲) or the Down button (▼) to choose the scheduled time. You can choose the time in 30 minutes intervals.

4.4.8.3 Setting the DHW Operation

To set the boiler's DHW operation, press the Menu button (M), and then select "3. DHW Operation".

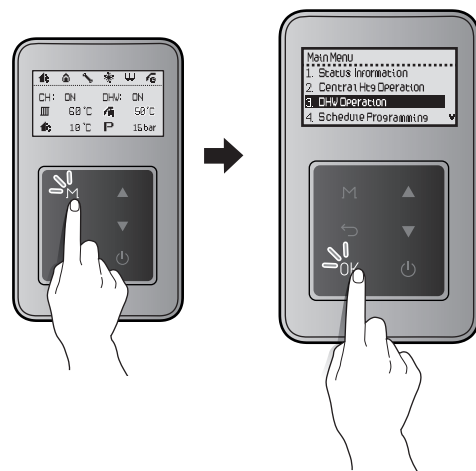

Press the Up button (▲) or the Down button (▼) to switch between the list items or to increase/decrease setting values. Press the OK button (OK) to select an item or to confirm after making changes.

Press the Back button (↶) to return to the previous screen or menu.

Item	Description								
1. Cylinder Controls	Set DHW demand received from the cylinder. 1: Cylinder Stat 2: Cylinder Sensor 3: Wiring Center 4: No Cylinder Control • Default: Cylinder Stat								
2. DHW Schedule	Set the domestic hot water weekly timer. 1: DHW Schedule								
	<table border="1"> <thead> <tr> <th>Item</th> <th>Description</th> </tr> </thead> <tbody> <tr> <td>1. 7 Day</td> <td>Schedule a command for each day of the week.</td> </tr> <tr> <td>2. 5 + 2 Day</td> <td>Schedule a command for weekday and weekend.</td> </tr> <tr> <td>3. 5 + 1 + 1 Day</td> <td>Schedule a command for weekdays, Saturdays, and Sundays.</td> </tr> </tbody> </table>	Item	Description	1. 7 Day	Schedule a command for each day of the week.	2. 5 + 2 Day	Schedule a command for weekday and weekend.	3. 5 + 1 + 1 Day	Schedule a command for weekdays, Saturdays, and Sundays.
	Item	Description							
	1. 7 Day	Schedule a command for each day of the week.							
2. 5 + 2 Day	Schedule a command for weekday and weekend.								
3. 5 + 1 + 1 Day	Schedule a command for weekdays, Saturdays, and Sundays.								
2: DHW Always ON 3: DHW OFF									
3. DHW Tank Set Temp	Cylinder sensor • Setting range: 30 – 65°C • Default: 50°C								
4. DHW Boiler Set Temp	Cylinder stat • Setting range: Central heating supply water (40°C (Absolute MIN) – 90°C) • Default: 50°C Cylinder sensor • Range: (DHW tank set temp + 10°C) ~ Supply absolute max set-point • Default: 85°C								
5. DHW Priority Time	DHW priority time • Range : 0 – 180 min • Default : 30 min								

4.4.8.4 Setting the Schedule Programming

To set the boiler's schedule programming operation, press the Menu button (M), and then select "4. Schedule Programming".

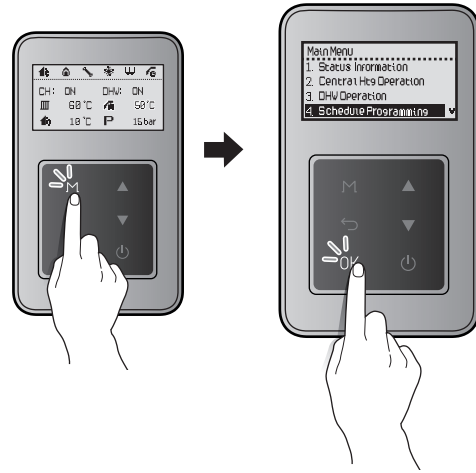

Press the Up button (▲) or the Down button (▼) to switch between the list items or to increase/decrease setting values. Press the OK button (OK) to select an item or to confirm after making changes.

Press the Back button (↶) to return to the previous screen or menu.

Item	Description
1. CH Schedule	Check the central heating weekly schedule.
2. DHW Schedule	Check the DHW weekly schedule.

WARNING

- Most Legionella can be sterilised in a few minutes in water above 60°C.
- If you enable the "Anti-Legionella" function, the boiler may operate from 1 A.M every Monday.
- If you enable the "Anti-Legionella" function, be careful not to get burnt when you use DHW in the set time or not sufficiently cooled (4-5 hours).

4.4.8.5 Viewing Error History

To view the error history, press the Menu button (M), and then select "5. Error History".

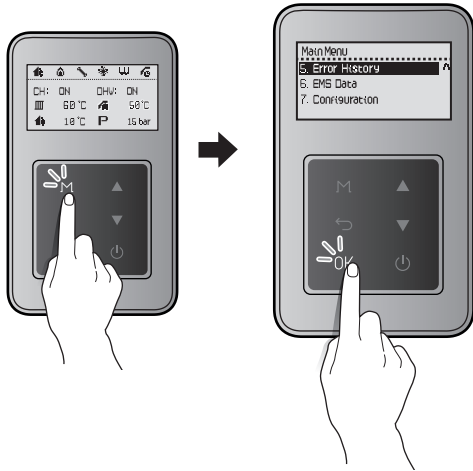

A list of 10 recent errors are displayed on the screen, with the most recent error displayed at the top of the list.

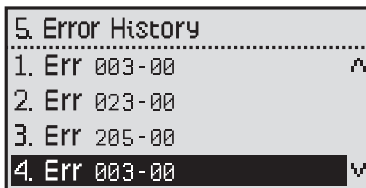

Press the Up button (▲) or the Down button (▼) to switch between the list of Errors. Press the OK button (OK) to select an error to view detailed information.

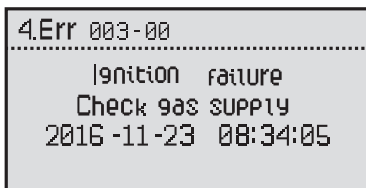

Press the Back button (←) to return to the previous screen or menu.

- Note**
- The front panel display flashes in red and the error icon is displayed (flashing) when a level 1 error is detected. You can press the OK button (OK) to enter error display mode. Boiler operation is maintained during a level 1 error.
 - A level 1 error is automatically cleared when the problem is resolved.

4.4.8.6 Viewing Other System Information

To view the miscellaneous system information, press the Menu button (M), and then select "6. EMS Data".

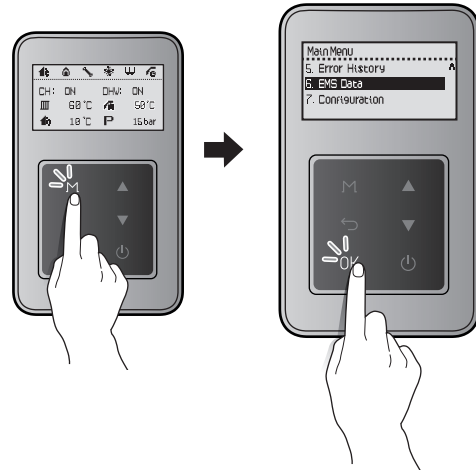

Press the Up button (▲) or the Down button (▼) to switch between the information items. Press the OK button (OK) to select an item and view the information.

Press the Back button (←) to return to the previous screen or menu.

Item	Description
1. CH Operation Time	View monthly central heating operation logs.
2. DHW Operation Time	View monthly DHW operation logs.
3. No. of CH Operation	View the number of times the central heating operation function has been used.
4. No. of DHW Operation	View the number of times the DHW operation function has been used.
5. Gas Consumption	View monthly gas consumption.

4.4.8.7 Setting the Display Options

To set the front panel display options, press the Menu button (M), and then select "7. Configuration".

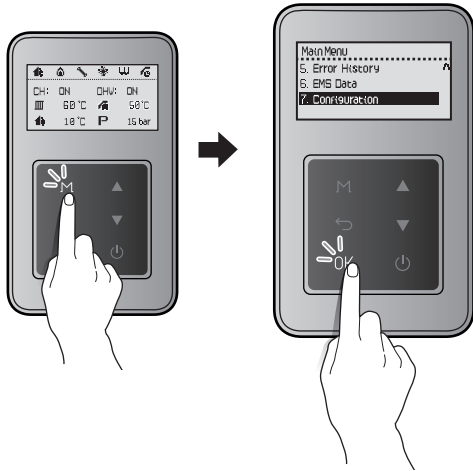

Press the Up button (▲) or the Down button (▼) to switch between the list items or to increase/decrease setting values. Press the OK button (OK) to select an item or to confirm after making changes.

Press the Back button (↶) to return to the previous screen or menu.

Item	Description
1. Time Setting	Set the time. <ul style="list-style-type: none"> Setting range: <ul style="list-style-type: none"> - YYYY : MM : DD - HH : MM : SS Default : Set current time
2. Backlight Time Setting	Set the backlight time. <ul style="list-style-type: none"> Setting range: OFF /1– 60 sec Default: 10 sec
3. Sound Setting	Set the backlight time <ul style="list-style-type: none"> Setting range: OFF/ON Default; ON

4.4.9 Accessing Advanced Menu Items

4.4.9.1 Viewing Service Information

To view the service information about the boiler, press the Back button (↶) and the Menu button (M) simultaneously for 3 seconds, and then select "1. Service Status Info".

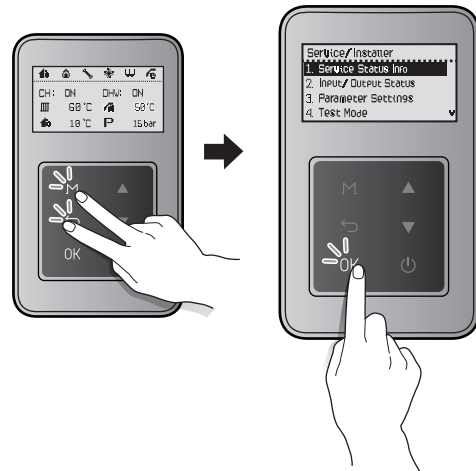

Press the Up button (▲) or the Down button (▼) to switch between the information items. Press the OK button (OK) to select an item and view the information.

Press the Back button (↶) to return to the previous screen or menu.

Item	Description
1. Elapsed Time After Install	Elapsed time since installation
2. HEX Overheat - No. of Times	Number of times the heat exchanger high limit stat has activated
3. Flame Loss - No. of Times	Number of times a flame loss/misfire has occurred
4. 2nd ignition - No. of Times	Number of second ignition attempts
5. 3rd ignition - No. of Times	Number of third ignition attempts
6. 4th ignition - No. of Times	Number of fourth ignition attempts
7. 5th ignition - No. of Times	Number of fifth ignition attempts

4.4.9.2 Viewing Input and Output Status

To view the boiler's input and output status, press the Back button (↶) and the Menu button (M) simultaneously for 3 seconds, and then select "2. Input/Output Status".

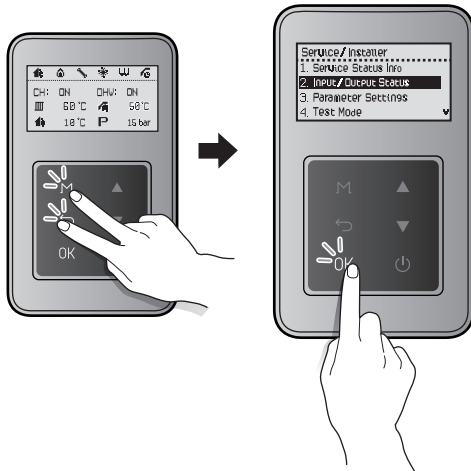

Press the Up button (▲) or the Down button (▼) to switch between the information items. Press the OK button (OK) to select an item and view the information.

Press the Back button (↶) to return to the previous screen or menu.

Item	Description
1. CH Switched Live Status	CH switched live input status
2. CH Thermostat Status	CH thermostat input status
3. Cylinder Stat Status	Cylinder Stat output status
4. HTL Input Status	Cylinder Stat input status

4.4.9.3 Setting the Operation Parameters

To set the boiler's operation parameters, press the Back button (↶) and the Menu button (M) simultaneously for 3 seconds, and then select "3. Parameter Settings".

⚠ CAUTION

Parameters must be set by a qualified professional with an extensive understanding of the boiler system. Setting parameters improperly may lead to property damage or injury.

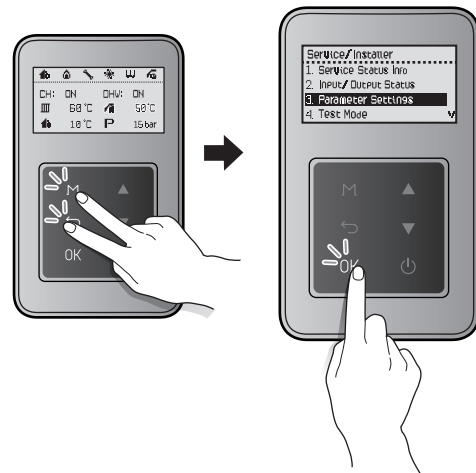

In the password screen, press the Up button (▲) or the Down button (▼) to change numbers and places, and press the OK button (OK) to enter the password.

The factory default password is "1234".



After entering the parameter setting screen, press the Up button (▲) or the Down button (▼) to switch between the parameters or to increase/decrease setting values. Press the OK button (OK) to select a parameter or to confirm after making changes.

Press the Back button (←) to return to the previous screen or menu.

Item	Description
1. Supply MIN Set-point	Set the central heating supply minimum temperature. <ul style="list-style-type: none"> Setting range: 25°C – [MAX Set-point – 20°C] Default: 40°C
2. Supply MAX Set-point	Set the central heating supply maximum temperature. <ul style="list-style-type: none"> Setting range: [MIN Set-point + 20°C] – 90°C Default: 85°C
3. Return MIN Set-point	Set the central heating supply minimum temperature. <ul style="list-style-type: none"> Setting range: [MAX Set-point - 10°C] Default: 30°C
4. Return MAX Set-point	Set the central heating supply maximum temperature. <ul style="list-style-type: none"> Setting range: 20°C - [MAX Setpoint - 10°C] Default: 65°C
5. CH Burning Off Diff	Set the temperature range to turn off central heating. <ul style="list-style-type: none"> Setting range: 1°C – 30°C Default: 2°C
6. CH Burning On Diff	Set the temperature range to turn on central heating. <ul style="list-style-type: none"> Setting range: 1°C – 30°C Default: 3°C
7. Anti Fast Cycling Time*	Set the anti-fast cycling time. <ul style="list-style-type: none"> Setting range: 0 – 20 min Default: 3 min
8. Freeze protection	Set the pump freeze protection temperature. <ul style="list-style-type: none"> Setting range: 6°C – 10°C Default: 10°C <p>Note The system freeze protection temperature is set based on the pump freeze protection temperature.</p>
9. Boiler Pump Delay	Set the boiler pump off delay time. <ul style="list-style-type: none"> Setting range: 3 – 40 min Default: 40 min

Item	Description
10. CH Min Limit	Set the central heating minimum heat capacity limit. <ul style="list-style-type: none"> Setting range : Default value to 80% <p>Note Minimum heat capacity will always be at least 20% lower than maximum heat capacity.</p> <ul style="list-style-type: none"> Default : Boiler's minimum heat capacity 32kW 14% / 37kW 12% / 41kW 11%
11. CH Max Limit	Set the central heating maximum heat capacity limit. <ul style="list-style-type: none"> Setting range: [Minimum heat capacity value + 20%] to 100% <p>Note Minimum heat capacity will always be at least 20% higher than the minimum heat capacity.</p> <ul style="list-style-type: none"> Default: 100%
12. DHW Min Limit	Set the DHW Supply minimum heat capacity limit. <ul style="list-style-type: none"> Setting range: Default value to 80% <p>Note Minimum heat capacity will always be at least 20% lower than maximum heat capacity.</p> <ul style="list-style-type: none"> Default: Boiler's minimum heat capacity
13. DHW Max Limit	Set the DHW supply maximum heat capacity limit. <ul style="list-style-type: none"> Setting range: [Minimum heat capacity value + 20%] to 100% <p>Note Maximum heat capacity will always be at least 20% higher than minimum heat capacity.</p> <ul style="list-style-type: none"> Default: 100%
14. DHW Demand On Diff	DHW tank sensor demand on diff <ul style="list-style-type: none"> Range: 0°C – 10°C Default: 3°C

Item	Description
15. DHW Demand Off Diff	DHW tank sensor demand off diff <ul style="list-style-type: none"> • Range: 0°C – 5°C • Default: 0°C
16. CH Min Burning Time	Set the low-load combustion time at initial operation. <ul style="list-style-type: none"> • Setting range: 1 – 20 min • Default: 1 min
17. Burning Acceleration Time	Set the time to reach the maximum central heating capacity after initial operation. <ul style="list-style-type: none"> • Setting range: 0 – 20 min • Default: 1 min
18. Service Notify Time	Set the time for service notification. <ul style="list-style-type: none"> • Setting range: 30 – 3650 days (10 years) • It can be set in 10 day increments. • Default: 1820 days (5 years)
19. Service Notify Cycle	Set the service notification according to the operating times. <ul style="list-style-type: none"> • Setting range: 300 – 36500 cycles • It can be set in 100 cycle increments. • Default: 18200 cycles
20. Low Water Pressure	Set the lowest operating pressure of the boiler. <ul style="list-style-type: none"> • Setting range: 0.1 – 1.2 bar • Default: 0.4 bar
21. Supply Boost Time	Set the time that the burner (CH) boost supply set temperature. <ul style="list-style-type: none"> • Setting range: OFF, 30 – 120 min • Default: OFF
22. Gas Compensation setting	Adjust the gas usage estimates to improve accuracy. <ul style="list-style-type: none"> • Setting range: -25% – 25% • Default: 0%
23. Factory Reset	Initialise all parameter settings (panel and main controller) to factory default.
24. P/W Change	Change the parameter setting password. Press the Up button (▲) or the Down button (▼) to change numbers and places, and press the OK button (OK) to save the new password.

4.4.9.4 Diagnosing the Boiler System

To run a series of test procedures for a system diagnosis, press the Back button (↶) and the Menu button (M) simultaneously for 3 seconds, and then select "4. Test Mode".

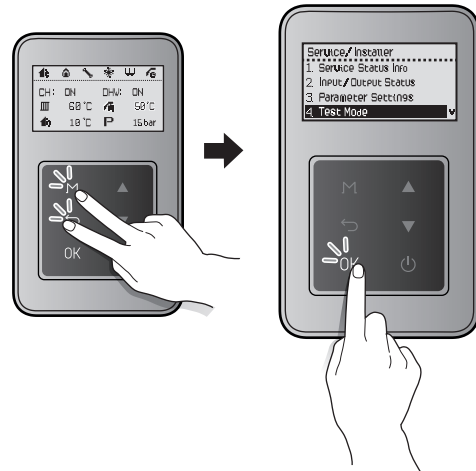

Press the Up button (▲) or the Down button (▼) to switch between the test procedures. Press the OK button (OK) to run a test procedure.

Note During the test mode, the boiler stops combustion.

Press the Back button (↶) to return to the previous screen or menu.

Item	Description
1. Fan Motor	Test the fan operation. From a stopped state, the fan speed gradually increases and reaches the maximum speed at 6500 RPM, and then the fan speed decreases until the fan stops operating. Note Except for the Power button (⏻), the buttons do not work during fan motor test mode.
2. Circ Pump (Heating)	Test the boiler pump operation. On (10 seconds) -> Off (5 seconds) -> On (10 seconds) for 5 boiler pump operation cycles Note Except for the Power button (⏻), the buttons do not work during boiler pump test mode.

4.4.9.5 Setting the Special Operation Modes

To operate the boiler in special operation modes, press the Back button (↶) and the Menu button (M) simultaneously for 3 seconds, and then select "5. Special Operations".

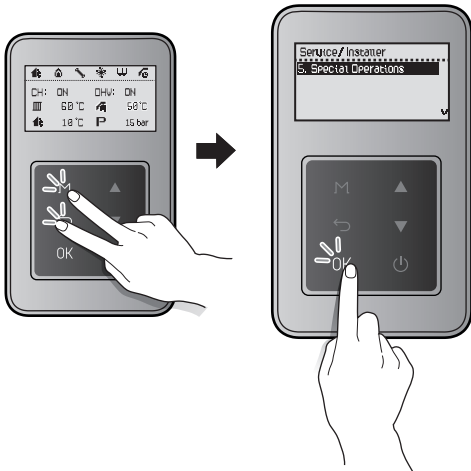

Press the Up button (▲) or the Down button (▼) to switch between the operation modes. Press the OK button (OK) to select an operation mode.

The boiler resumes operation in normal operation mode if no input is detected for 3 hours.

Press the Back button (↶) to return to the previous screen or menu.

Item	Description
1. Normal	Set the boiler to run in normal operation mode.
2. MIN	Set the boiler to run in minimum operation mode.
3. CH MAX	Set the boiler to run in central heating maximum operation mode.

Note The boiler will operate only within the set target temperatures for heating and hot water, and these temperatures cannot be overridden in the special operation mode. If the boiler stops while in this operation mode, adjust the temperature settings.

4.5 Wiring Diagram

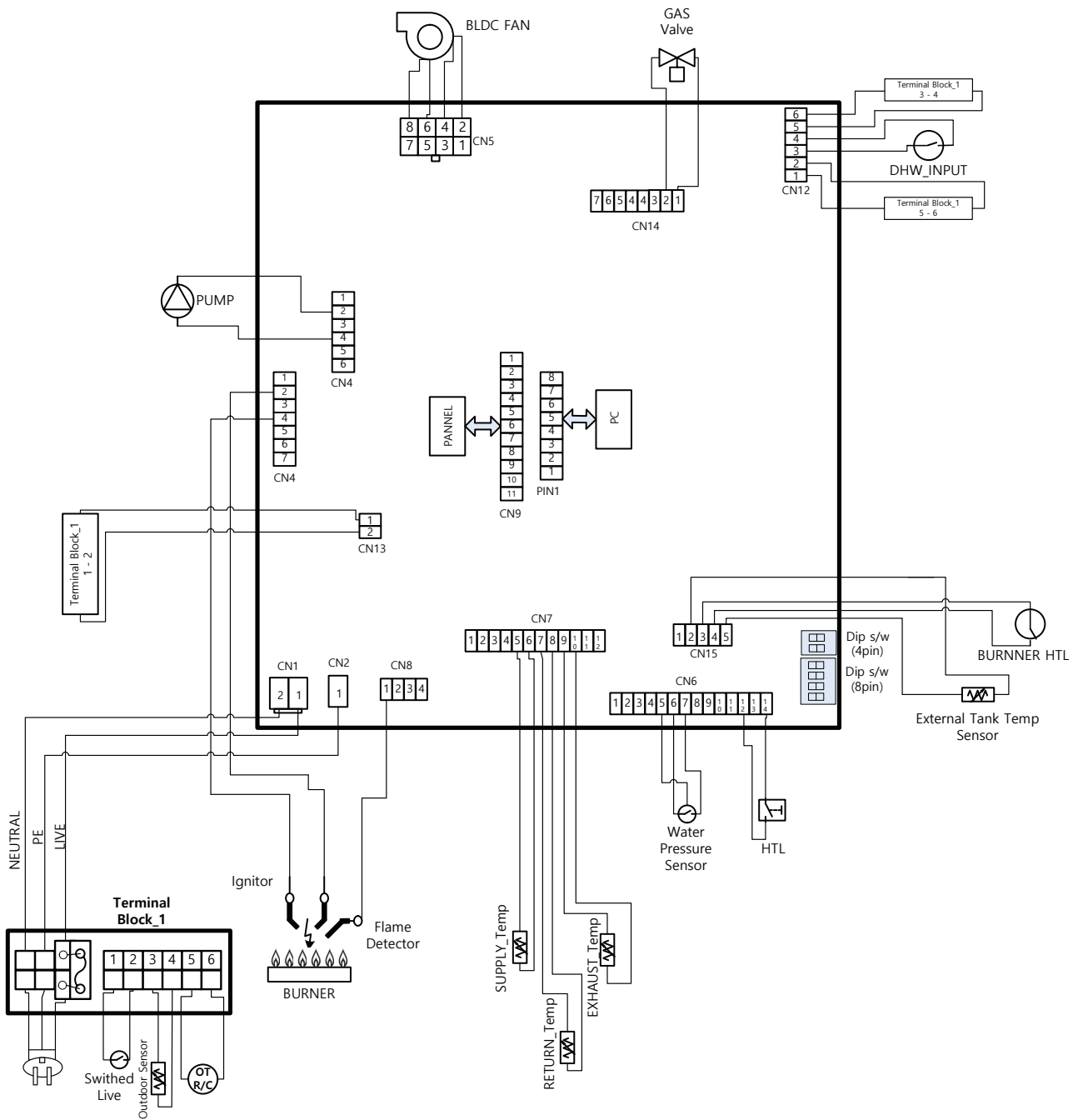

4.6 Ladder Diagram

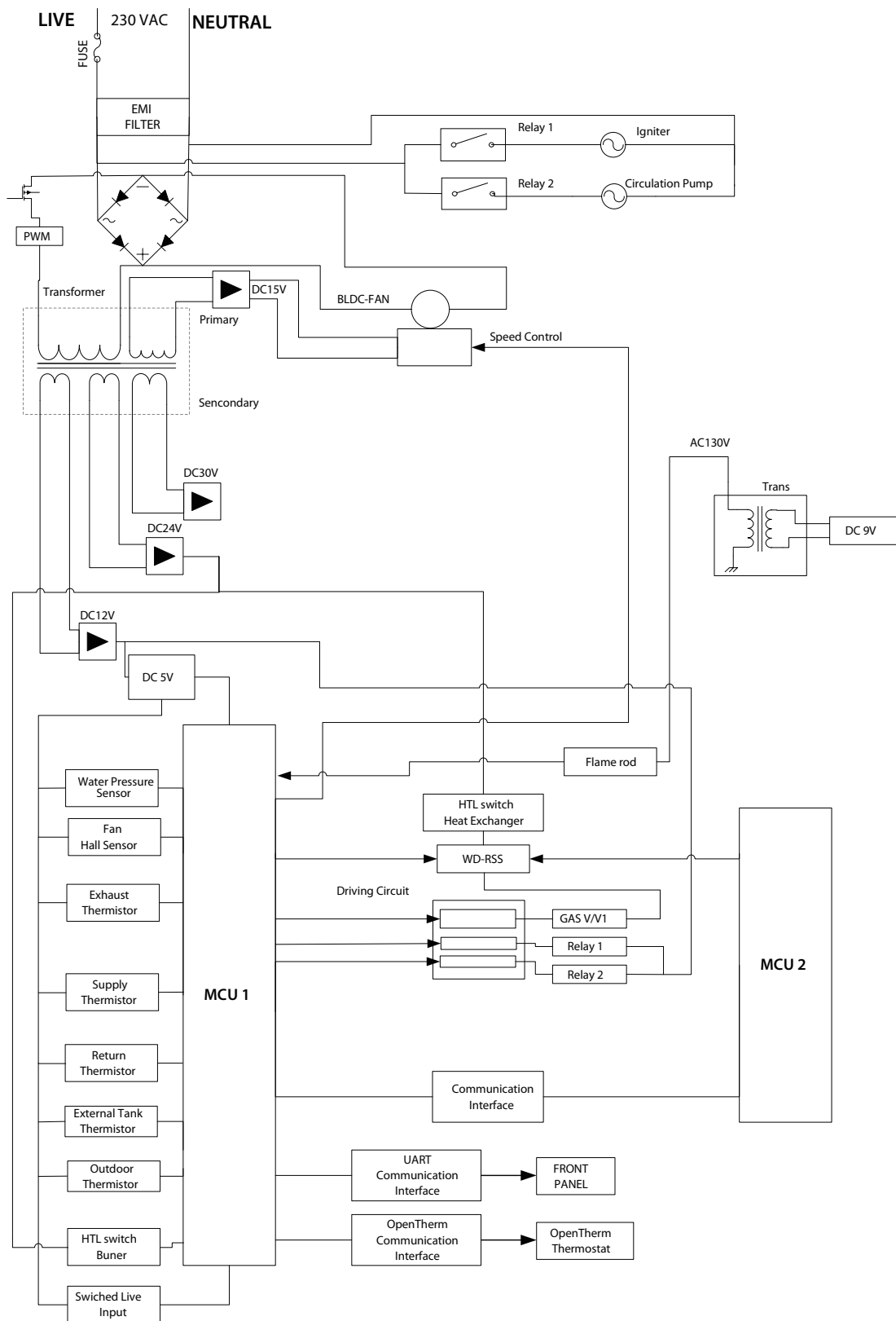

4.7 Key Component Descriptions

4.7.1 PCB

Item	Description
Function	Controls each component and monitors the overall performance of the unit.
Fault	PCB malfunction
Symptoms	A system component may not operate and generate an error code. In most PCB failures, the boiler will not operate until the fault is resolved.
Error codes	E515, E615
Diagnostics	Visual inspection: Check wire connections are secure and inspect for wire damage, and/or PCB heat damage.
Testing/inspection information	

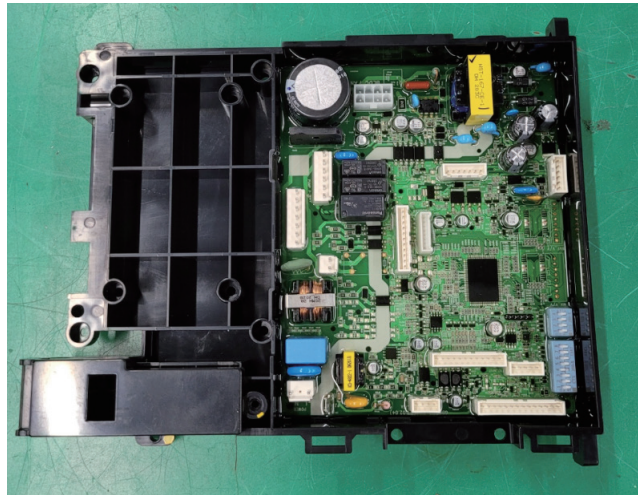

4.7.2 High Temperature Limit Switch

Item	Description
Function	<ol style="list-style-type: none">1. Overheat prevention switch.2. If the switch detects extremely high temperature, the boiler will automatically trip and shut down.3. Excessive high water temperatures (> 105°C) in the heat exchanger will activate the high limit switch.
Fault	Unable to detect high water temperature conditions if the switch malfunctions.
Symptoms	Unable to shut down the boiler if the water temperature from the heat exchanger exceeds 105°C.
Error codes	E016, E046
Diagnostics	<ol style="list-style-type: none">1. Visual inspection: Check wire connections are secure and inspect for wire damage.2. Resistance test: Confirm that the resistance is within the specification shown below.
Testing/inspection information	Resistance range: < 1.0Ω



4.7.3 Thermistor

Item	Description
Function	Measure hot and cold water temperature at the boiler's space heating outlet and inlet connections.
Fault	Inaccurate water temperatures from inside the boiler.
Symptoms	<ol style="list-style-type: none"> 1. If a thermistor fails, an error code is displayed before the boiler operates. 2. If resistance values are outside the allowable range, there will be hot water temperature fluctuations.
Error codes	E047, E205, E218
Diagnostics	<ol style="list-style-type: none"> 1. Visual inspection: Check wire connections are secure and inspect for wire damage. 2. Test the resistance of the sensor. Before testing, shut down the boiler and allow it to cool.
Testing/inspection information	Resistance range: Refer to the table below

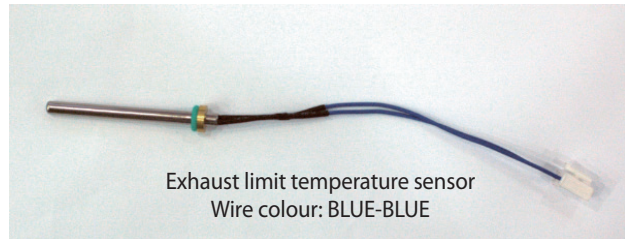
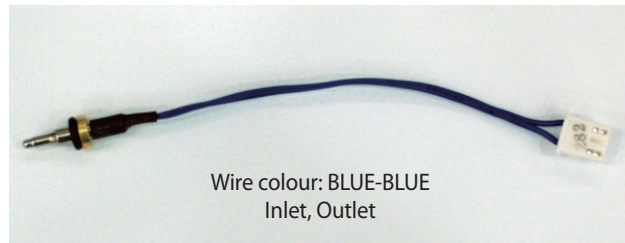

Test for an open hot water temperature sensor (Test result: MΩ open)

Temp (°C)	Thermistor (kΩ) [Space heating line]	Thermistor (kΩ) [DHW line]	Exhaust Limit Temperature Sensor (kΩ)
0-5	23.4-19.1	27.5-22.2	162.3-125.9
6-10	18.3-15.5	21.2-18.0	119.8-98.5
11-15	14.8-12.6	17.3-14.7	93.8-77.6
16-20	12.1-10.7	14.2-12.1	74.0-61.6
21-25	10.3-8.5	11.6-10.0	58.8-49.2
26-30	8.2-7.0	9.6-8.3	47.1-39.5
35-40	6.8-4.9	8.0-6.9	37.9-32.0

4.7.4 Fan Motor

Item	Description
Function	Supplies combustion air for the burner and purges exhaust flue gas. To maintain gas input over long flue runs, the fan use APS to provide ideal combustion levels.
Fault	<ol style="list-style-type: none">1. Fan speed failure: When fan speed is approximately 0 rpm.2. A fan assembly screw is loose and/or the fan is disassembled.3. Disconnected or defective fan connection terminal assembly.
Symptoms	<ol style="list-style-type: none">1. Erratic combustion.2. Vibration and noise coming from the boiler.3. The boiler does not operate correctly.
Error codes	E109, E110
Diagnostics	<ol style="list-style-type: none">1. Visual inspection: check the fan's wiring connections and mounting.2. Voltage test: Test the fan voltage for the specified voltage shown below.
Testing/inspection information	Black - Yellow: DC 340 V

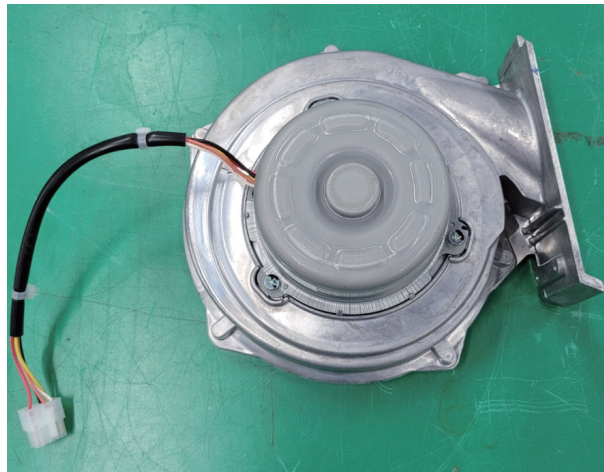

4.7.5 Flame Rod Assembly

Item	Description
Function	Repeatedly discharges a high voltage spark at the main burner until the gas ignites.
Fault	<ol style="list-style-type: none"> 1. Unable to ignite the gas. 2. Results in multiple unsuccessful ignition attempts.
Symptoms	<ol style="list-style-type: none"> 1. The boiler does not ignite and error code E003 or E004 is displayed. 2. The durability of the igniter reduces.
Error codes	E003, E004, E012
Diagnostics	Visual inspection: Check wire connections are secure and inspect for wire damage.
Testing/inspection information	BLACK: 0-10 μ A

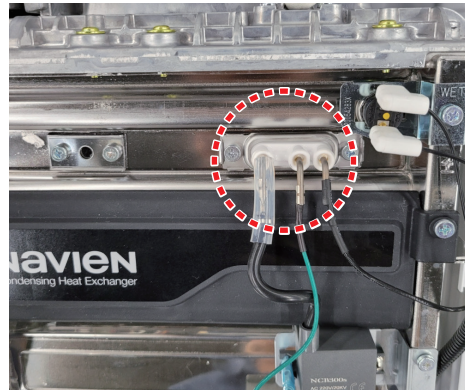
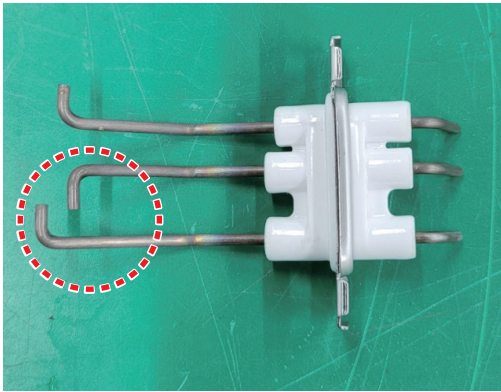

Ignition gap: 3.5-4.5 mm (1/8")

4.7.6 Ignition Transformer

Item	Description
Function	Provides voltage for the igniter for gas ignition purposes.
Fault	<ol style="list-style-type: none"> 1. The igniter is unable to ignite the gas. 2. Results in multiple unsuccessful ignition attempts to.
Symptoms	<ol style="list-style-type: none"> 1. The boiler does not ignite and error code E003 or E004 is displayed. 2. Durability of the transformer wears down.
Error codes	E003, E004
Diagnostics	<ol style="list-style-type: none"> 1. Visual inspection: Check wire connections are secure and inspect for wire damage. 2. Voltage test: Test the voltage meets the specifications shown below.
Testing/inspection information	BROWN - BLUE <ul style="list-style-type: none"> • On: AC 230 V • Off: 0V

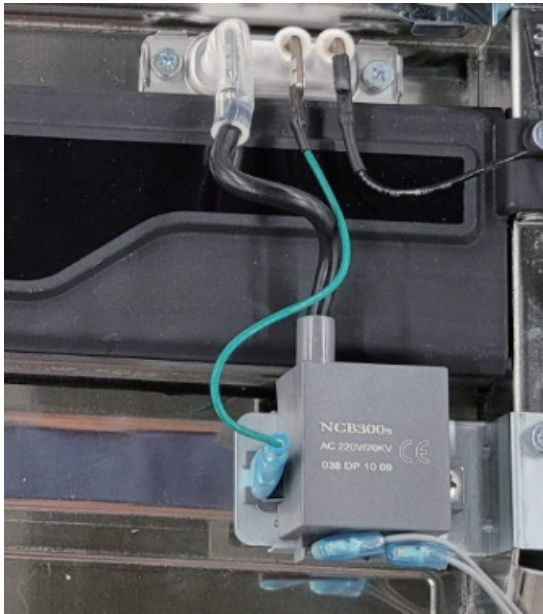

Input Voltage	Output Voltage	Output Current
230 V, 50 Hz	±20 kV	10 mA, ±2 mA

4.7.7 Main Gas Valve

Item	Description
Function	<ol style="list-style-type: none"> 1. Controls the amount of gas supplied to the burner based on fan speed. 2. When the unit experiences abnormal combustion, it automatically shuts off the gas supply to prevent unsafe situations.
Fault	Unable to open / close
Symptoms	<ol style="list-style-type: none"> 1. No flame. 2. The boiler does not operate.
Error codes	E003, E012
Diagnostics	<ol style="list-style-type: none"> 1. Visual inspection: Check wire connections are secure and inspect for wire damage. 2. Check that the solenoid valve of Main Gas Valve works properly. <ul style="list-style-type: none"> • Voltage test: Test the voltage meets the specifications shown below.
Testing/inspection information	WHITE - YELLOW/Connector Pin 1 and 5: DC 24 V

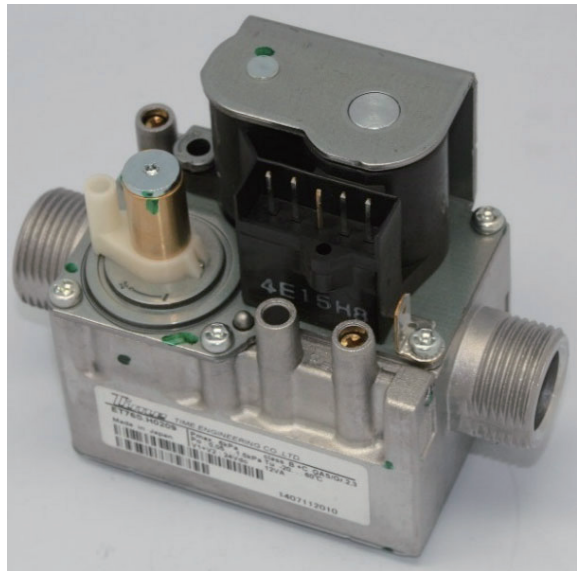
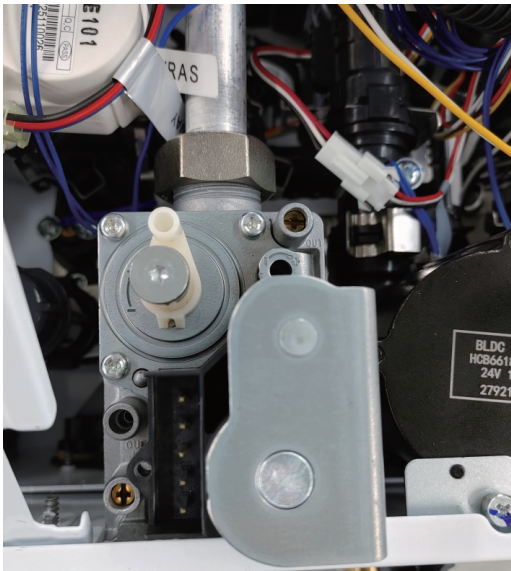

4.7.8 Burner

Item	Description
Function	<ol style="list-style-type: none"> 1. Pre-mixes air and gas to reduce emissions and increase efficiency. 2. The burner produces the optimum air/gas mixture required to produce the correct level of heat during combustion.
Fault	<ol style="list-style-type: none"> 1. Unable to initiate or sustain combustion. 2. Dust or soot deposits form on the burner's surface. 3. Gas leakage from the burner.
Symptoms	<ol style="list-style-type: none"> 1. Abnormal combustion. 2. Unstable flame conditions and / or flame loss. 3. Ignition failure.
Error codes	E003, E004, E012
Diagnostics	Visual inspection: Check for deposits forming on the burner surface and / or unstable flame conditions during operation.

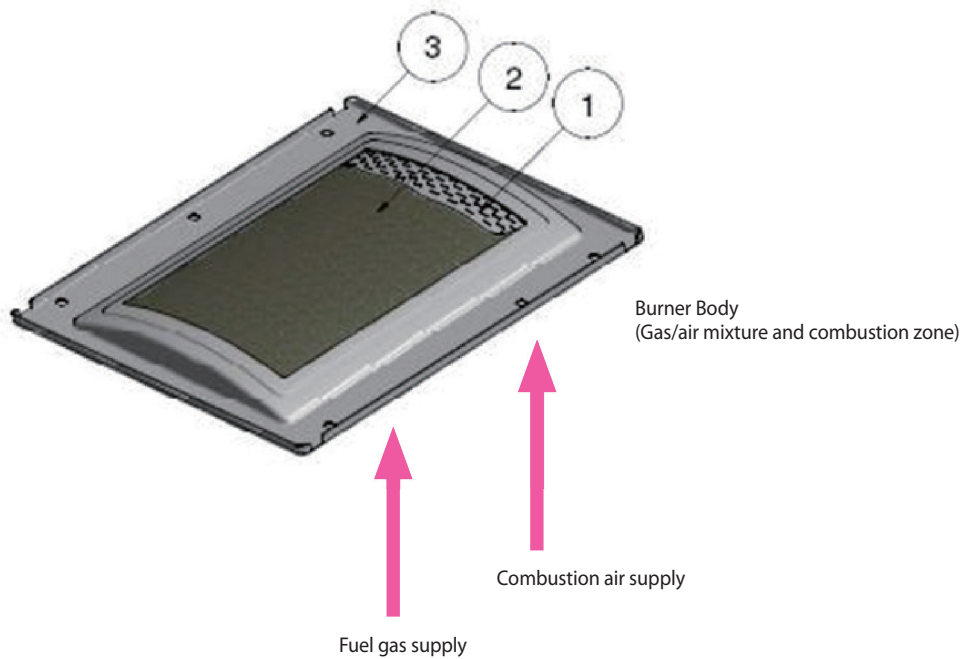

4.7.9 Primary Heat Exchanger

Item	Description
Function	<ol style="list-style-type: none">1. Main component used in the boiler for heat transfer.2. Multiple pipes on surface of the heat exchanger and inside the combustion chamber are used to minimise heat loss.
Fault	<ol style="list-style-type: none">1. Water and / or exhaust gas leaks.2. Scale deposits in the heat exchanger can cause water in the boiler to bubble.
Symptoms	<ol style="list-style-type: none">1. Exhaust gas leaks.2. Overheating of water causes bubbling noises.
Error codes	E016, E030, E047
Diagnostics	<ol style="list-style-type: none">1. Visual inspection: Check for surface cracks on the heat exchanger.2. Audible inspection: Listen for bubbling noises from inside the boiler.

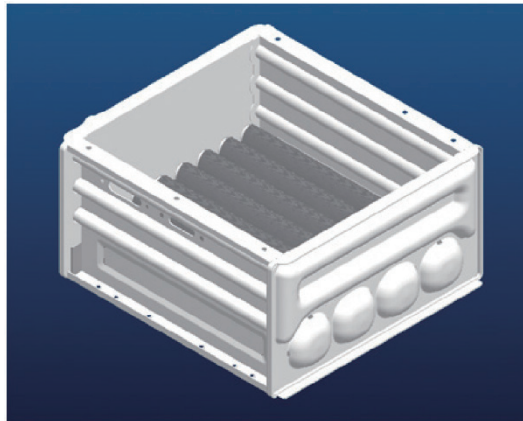

4.7.10 Secondary Heat Exchanger

Item	Description
Function	<ol style="list-style-type: none">1. Secondary component used in the boiler for heat transfer.2. There are multiple paths of water pipes on the heat exchanger as well as inside the combustion chamber which minimises heat loss.
Fault	<ol style="list-style-type: none">1. Water and / or exhaust gas leaks.2. Scale deposits in the heat exchanger can cause water in the boiler to bubble.
Symptoms	<ol style="list-style-type: none">1. Exhaust gas leaks.2. Overheating of water causes bubbling noises.
Error codes	E016, E030, E047
Diagnostics	<ol style="list-style-type: none">1. Visual inspection: Check for surface cracks on the heat exchanger.2. Audible inspection: Listen for bubbling noises from inside the boiler.

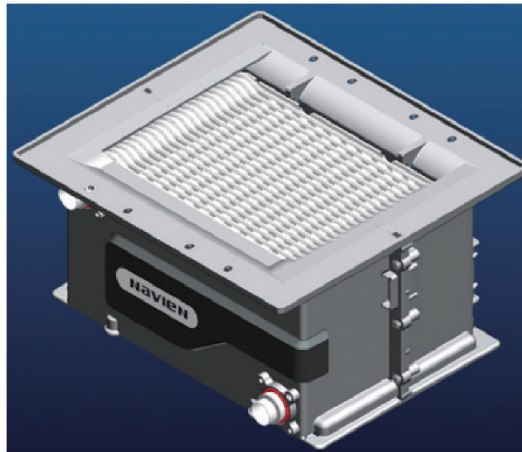

4.7.11 Circulation Pump

Item	Description
Function	<ol style="list-style-type: none"> 1. Provides internal or external water circulation. 2. Internal circulation minimises the effects of temperature fluctuations. External circulation quickly delivers hot water to taps and results in water conservation.
Fault	Unable to detect or measure water flow.
Symptoms	<ol style="list-style-type: none"> 1. Water inside the boiler system freezes. 2. Water temperature fluctuations when the boiler is set to internal recirculation. 3. Hot water takes a long time to be available at taps when the boiler is set to external recirculation.
Error codes	-
Diagnosics	<ol style="list-style-type: none"> 1. Visual inspection: Check the circulation pump connection wire. 2. Check the water filter for obstructions. 3. Voltage test: Test the voltage meets the specifications shown below. 4. Free a jammed pump rotor. If a pump is not moving it may be a build-up of debris in the pump which will prevent the internal rotor from turning. The pump has a built-in mechanism which will attempt to turn the pump when this happens. The pump can often be heard clicking repeatedly. This is the noise a pump will make when trying to free itself. If the pump is too clogged up to free itself the internal rotor may have to be turned manually. In the centre of the pump head there is a hole. Insert a long shank CROSS HEAD screwdriver and locate the tip into the rotor shaft. The shaft must be pushed in hard and then turned in order for it to engage it onto the rotor. Only then will the user be able to turn and free the rotor.
Testing/inspection information	YELLOW-WHITE <ul style="list-style-type: none"> • ON: AC 230 V • OFF: 0 V

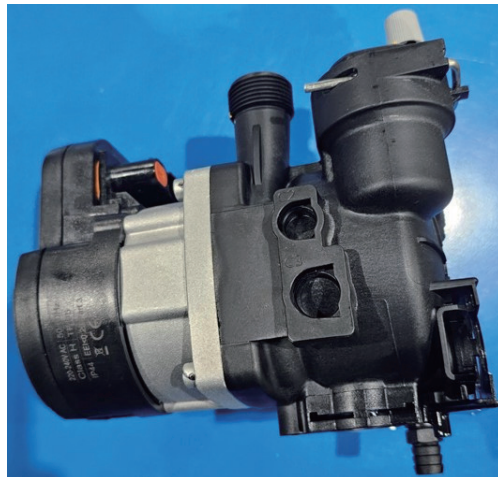

4.7.12 Water Pressure Sensor

Item	Description
Function	Analysis of heating system water pressure ratios.
Fault	Unable to detect or measure changes of water pressure.
Symptoms	The water top-up system does not operate automatically.
Error codes	E351, E352, E353
Diagnostics	1. Visual inspection: Check the circulation pump's wiring connections. 2. Voltage test: Test the voltage meets the specifications shown below.
Testing/inspection information	Black-Red: DC 0-5 V



4.7.13 Expansion tank

Item	Description
Function	<ol style="list-style-type: none">1. Removes air from the system during heating.2. Relieves system pressure caused by expansion as the water temperature increases.3. Uses a built-in low level water sensor to maintain the water in the boiler at a consistent volume.
	

5. Troubleshooting

5.1 Error Code Classification

When an error code appears on the front panel, refer to the following chart for a definition and possible remedy for the situation.

Item	Error Code	Description	Reset
Combustion	E001	Overheating of heat exchanger	Manual/Auto
	E003	Ignition failure	Manual
	E004	False flame detection	Auto
	E012	Flame loss	Manual
	E016	Heat exchanger overheat	Manual
	E030	Abnormal exhaust temperature	Manual/Auto
	E031	Burner overheat	Manual
	E046	Abnormal operation: Heat exchanger overheating sensor	Auto
	E047	Abnormal operation: Exhaust thermostat	Manual/Auto
Air Circulation	E109	Abnormal operation: Fan	Manual
Central Heating Circulation	E205	Heating supply thermistor open or short circuit	Auto
	E218	Heating return thermistor open or short circuit	Alarm/Auto
	E291	Supply/Return inversion limit	Manual
Water Supply	E302	Low water pressure	Manual/Auto
	E352	High water pressure	Auto
	E353	Abnormal operation: Water pressure sensor	Auto
DHW Circulation	E480	External tank thermistor open error	Alarm
		External tank thermistor short error	Alarm
Controller (PCB)	E515	Abnormal operation: Relay feedback (PCB)	Alarm/Manual
	E517	Abnormal operation: DIP switch setting (PCB)	Manual
	E593	Abnormal operation: Touch IC (Panel PCB)	Alarm
	E594	Abnormal operation: EEPROM (PCB)	Alarm/Manual
	E598	Abnormal operation: Panel real time clock	Alarm
Controller (MCU)	E615	Abnormal operation: Input and memory (MCU)	Manual
Installation	E740	Abnormal operation: Outdoor temperature sensor	Alarm
	E782	Abnormal operation: Main panel communication	Auto
	E783	Abnormal operation: OpenTherm remote control	Auto
	E787	Abnormal operation: Reset device	Power Reset
	E788	Abnormal operation: Gas type settings	Manual

If the error code is not cleared by resetting the boiler functioning (see "4.4.7 Resetting the Boiler") or if it occurs repeatedly, call the nearest official Technical Assistance Service (TAS), indicating the number of the error code appearing on the front panel.

5.2 Error Code List and Actions

Error Code	Sub Code	Function	Diagnosis/Actions
E001	0	Overheating of heat exchanger	<ol style="list-style-type: none"> 1. Clean the strainer. 2. Check voltage via PCB at the pump. 3. (AC 230 V) 4. Check that the flow rate is correct. 5. Check if water is circulating in the heating lines. 6. Check the heat exchanger and flush it with cleaning solution if necessary.
E003	0	Ignition failure	<ol style="list-style-type: none"> 1. Check the main gas supply 2. Check if the manual gas valve is open. 3. Check if the igniter is sparking. 4. Tighten the ground terminals on the heat exchanger.
E004	0	False flame detection	<ol style="list-style-type: none"> 1. Ensure that the ground wire is connected. 2. Check if the igniter is sparking.
E012	0	Flame loss	<ol style="list-style-type: none"> 1. Check if the main gas valve is open and verify the incoming gas pressure. 2. Check the gas valve inlet filter. 3. Check the ground wire. 4. Check the power supply. 5. Tighten the ground terminals on the heat exchanger. 6. Adjust the anti-short cycle time.
E016	0	Heat exchanger overheat	<ol style="list-style-type: none"> 1. Turn OFF the boiler, wait at least 30 min, and then restart the boiler. 2. Clean the inlet water filter and strainer. 3. Check the high limit switch and PCB. 4. Check the heat exchanger and flush it if required.
E030	0	Abnormal exhaust temperature.	<ol style="list-style-type: none"> 1. Turn OFF the boiler, wait at least 30 min, and then restart the boiler. 2. Clean the strainer. 3. Check the heat exchanger and flush it if required.
E031	2	Overheating of burner	<ol style="list-style-type: none"> 1. Turn off the boiler. 2. Check if all the valves on the distribution manifold are closed. 3. Check if the burner overheat prevention is disconnected.
E046	2	Abnormal operation: Heat exchanger overheating sensor	Check the heat exchanger thermistor connection.
E047	1	Exhaust thermistor open error	Check the exhaust thermistor connection.
	2	Exhaust thermistor short error	
E109	0	Fan motor activity error	<ol style="list-style-type: none"> 1. Check and clean the air intake filter. 2. Check and clean the fan motor. 3. Test the voltage from the PCB to ensure that it is correct. Replace fan if PCB voltage is normal.
E205	1	Heating supply thermistor open error	<ol style="list-style-type: none"> 1. Check the thermistor. 2. Check pump wiring connections.
	2	Heating supply thermistor short error	

Error Code	Sub Code	Function	Diagnosis/Actions
E218	1	Heating return thermistor open error	1. Check the thermistor.
	2	Heating return thermistor short error	
E291	3	Supply / Return inversion limit	Check the direct water connection.
E302	0	Low water pressure	1. Check filling link and pressurise system to 1.0 - 1.3 bar. 2. Check the incoming water pressure and activity at the PRV.
E352	0	High water pressure	1. Check filling link is not open and filling the system. 2. Check the incoming water pressure and activity at the PRV.
E353	1	Water pressure sensor open error	Check the water pressure sensor.
	2	Water pressure sensor short error	
E480	1	DHW tank thermistor open circuit	
	2	DHW tank thermistor short circuit	
E515	3	Abnormal operation: Relay feedback (PCB)	Check the PCB.
E517	0	Abnormal operation: DIP switch setting (PCB)	Check the dip switches on the front panel and the PCB.
E593	1	Abnormal operation: Touch IC (Panel PCB)	Check the front panel.
E594	0	Abnormal operation: EEPROM (PCB)	Check the PCB.
E615	3	Abnormal operation: Input and memory (MCU)	Replace the PCB.
E740	1	Abnormal operation: Outdoor temperature sensor	1. Ensure that outdoor reset curve is correctly configured. 2. Check the outdoor temperature sensor's wiring connections.
E782	0	Abnormal operation: Main panel communication	Check the PCB.
E783	0	Abnormal operation: OpenTherm remote control	
E787	1	Abnormal operation: Reset device	
E788	0	Abnormal operation: Gas type settings	

If the actions contained in the table above do not resolve the boiler fault, contact the **Navien technical support team on 1-800-519-8794**.

To assist with fault resolution, error codes are displayed on the front panel and saved on a PCB board in the boiler providing a record of the faults and failures that occur.



IMPORTANT

To reset the boiler, either press [Reset] on the front panel or turn off the boiler's power supply and then turn it on again.

5.2.1 Error 001

Error Conditions and Checklist

Error	Description
E001 Heat exchanger overheat	<ol style="list-style-type: none"> 1. If the space heating water temperature is higher than 105°C, E001 will be displayed on the front panel to warn users of high temperature conditions. 2. If the space heating water temperature decreases below 105°C, E001 will automatically reset and the boiler will repeat the combustion cycle. 3. If the overheat error is repeated consecutively three times, E001 will be displayed until the boiler is manually reset.
Checklist	<ol style="list-style-type: none"> 1. Check the operation of the circulation pump. Run it in test mode. 2. Check if the heating strainer is obstructed. 3. Check the heating inlet / outlet valve and distribution piping for obstructions. 4. Check the PCB DIP switch settings. 5. Check the PCB is operating properly. 6. If the fault condition remains after these checks, replace the PCB.

Scenario

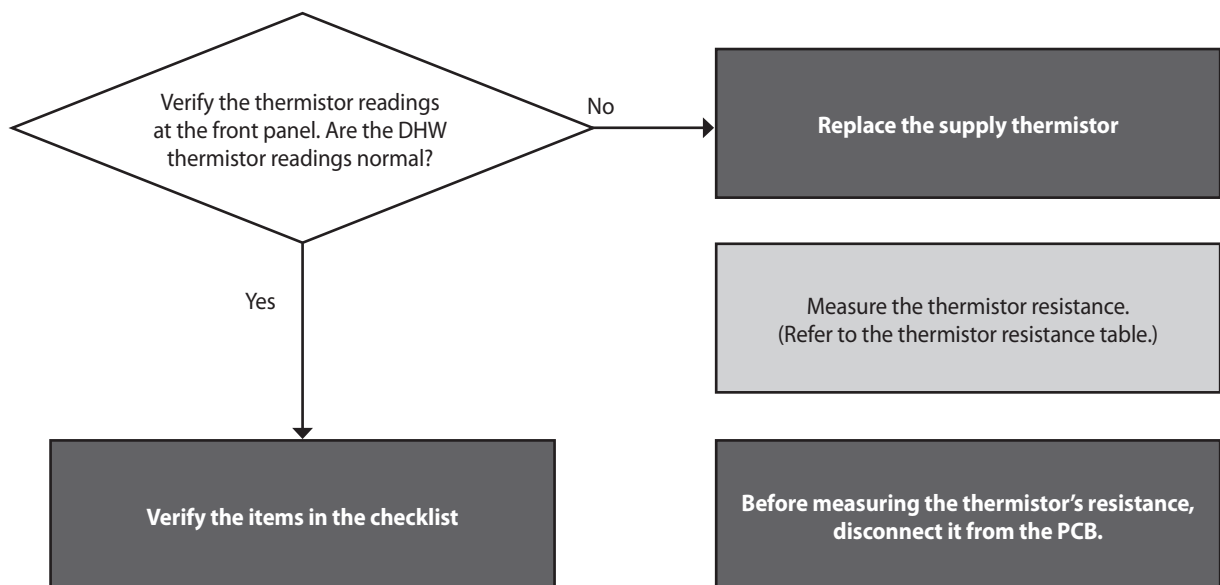

Testing methods

Error type	Cause	Testing method											
Circulation errors	Circulation pump fault	The circulation pump and fan run continuously in the error condition. 1. Check the power supply to the circulation pump (AC 230 V). 2. Replace the PCB if power is not available at the pump.											
	Heating strainer is obstructed	1. Check if the strainer is obstructed by debris. 2. Identify the type of debris caught in the strainer (aluminium, oxidised steel, etc.) to help identify the cause of the obstruction.											
	Heating is obstructed.	Disconnect the inlet and outlet pipes from the main heat exchanger. Blow air through the heat exchanger to check if the pipes are obstructed.											
	Valve closed	Check the heating inlet and outlet valves and the heating manifold pipes. At least one valve on the heating manifold must always be open.											
Other faults	Model settings	Sudden temperature increases due to PCB DIP switch setting errors or exceeding maximum settings. <table border="1" data-bbox="695 853 1430 1032"> <thead> <tr> <th rowspan="2">Model</th> <th colspan="2">DIP Switch Settings</th> </tr> <tr> <th>3</th> <th>4</th> </tr> </thead> <tbody> <tr> <td>NCB500-2S/37K</td> <td>ON</td> <td>OFF</td> </tr> <tr> <td>NCB500-2S+/41K</td> <td>OFF</td> <td>ON</td> </tr> </tbody> </table>	Model	DIP Switch Settings		3	4	NCB500-2S/37K	ON	OFF	NCB500-2S+/41K	OFF	ON
		Model		DIP Switch Settings									
3	4												
NCB500-2S/37K	ON	OFF											
NCB500-2S+/41K	OFF	ON											
PCB faults	If the error condition remains after checking these items, replace the PCB.												

5.2.2 Error 003

Error Conditions and Checklist

Error	Description
E003 Ignition fault	When ignition faults occur, the boiler will attempt ignition 5 times. If a flame does not start, the system displays E003 on the front panel. This error code can be cleared manually.
Checklist	<ol style="list-style-type: none"> 1. Check the gas supply valve is open and use a manometer to verify the supply pressure is correct. 2. Check the ignition gap, spark intensity, and flame rod deformation. 3. Check the operation of the ignition transformer (ignition state, input power (AC 230 V)) 4. Check the operation of the gas control valve (DC 24 V, coil short circuit, solenoid valve). 5. Check the flame rod, wiring, and grounding. 6. Check if the air pressure hose is broken or obstructed. 7. Check if the air pressure sensor is operating correctly. 8. Check the PCB DIP switch settings. 9. Adjust the offset pressure. 10. Check that the gas orifice used is for the correct gas type. 11. Check the flue and air intake for accumulated water (for vertical flue installations). 12. Tighten the ground connection screws on the heat exchanger. 13. If the error conditions remain after checking these items, replace the PCB.

Scenario1

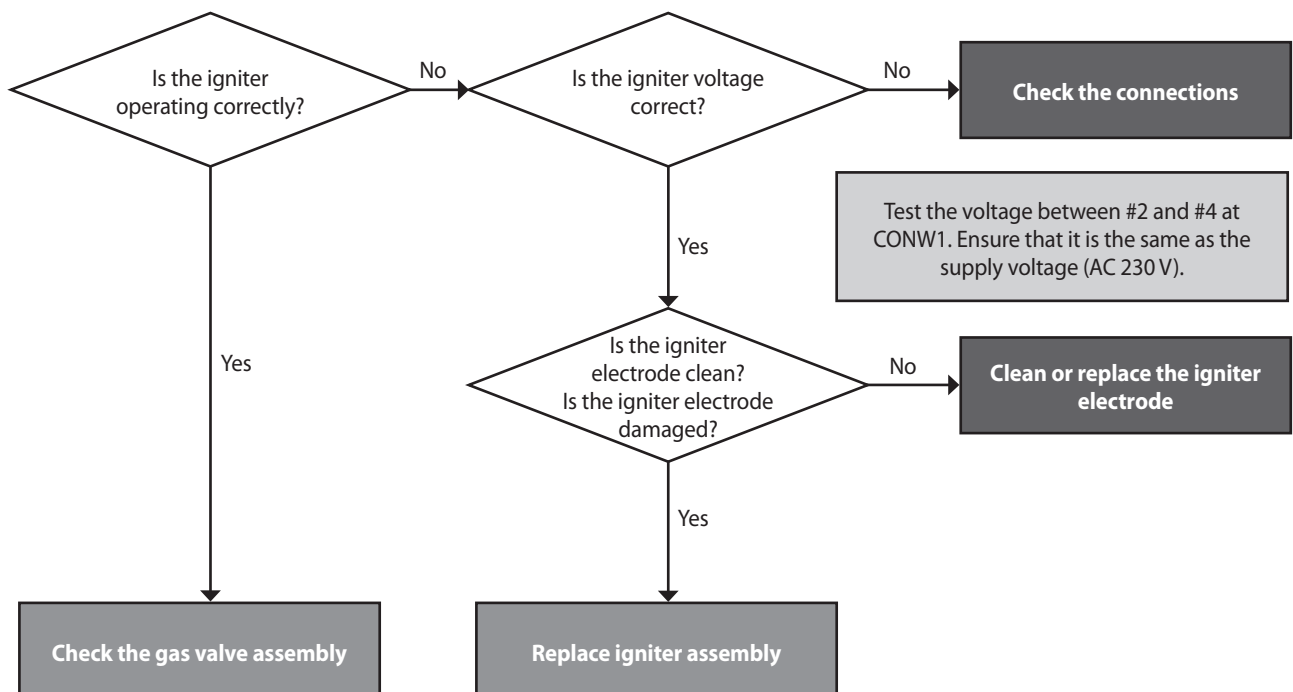

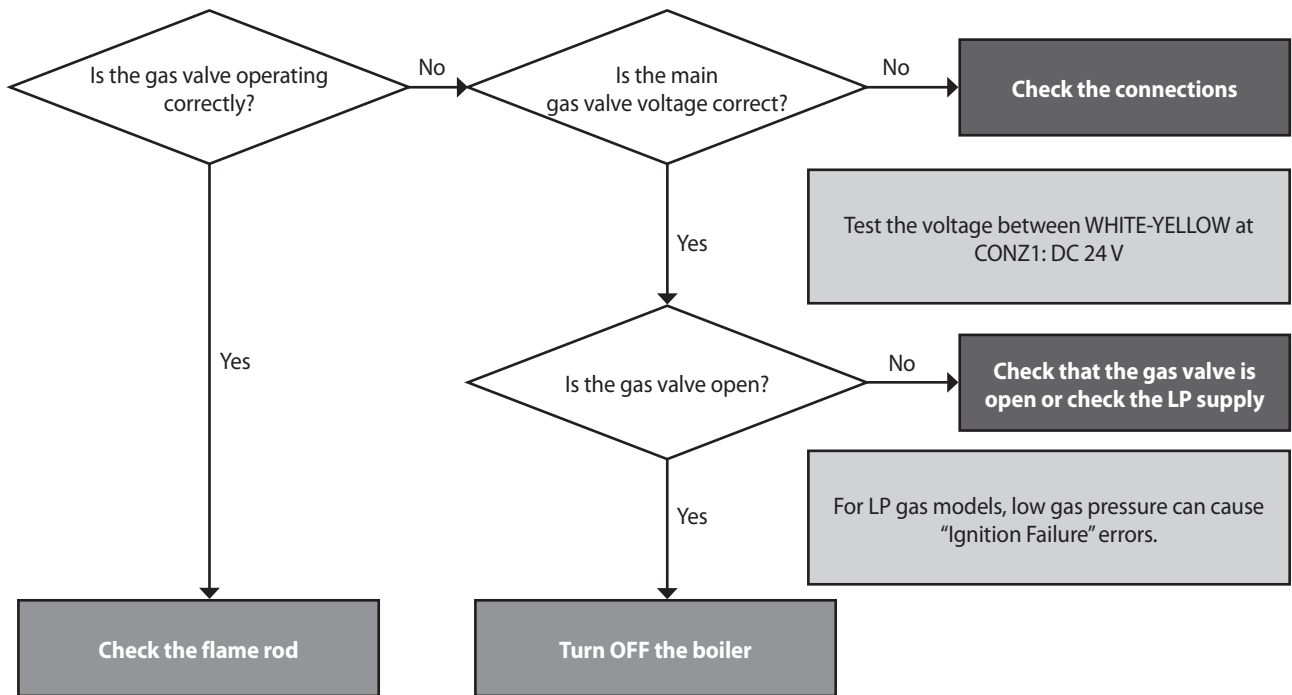

Scenario2



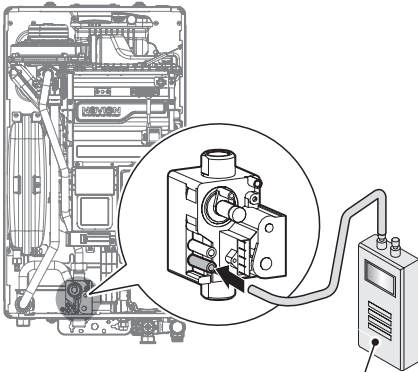
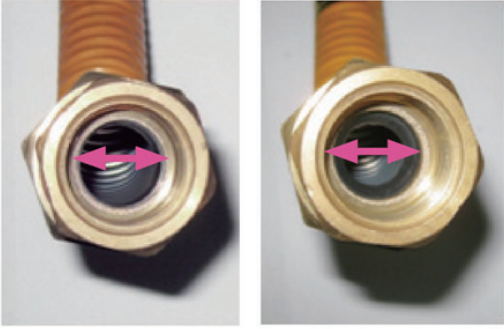

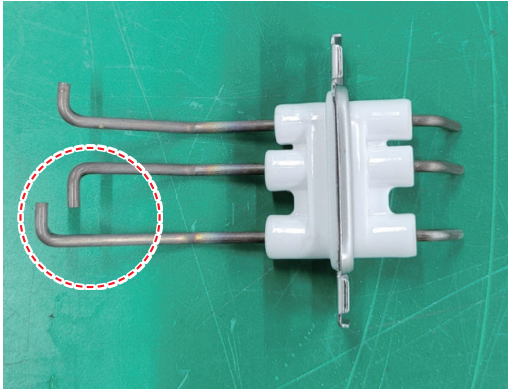
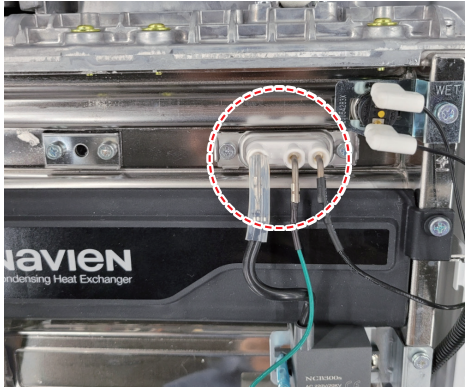
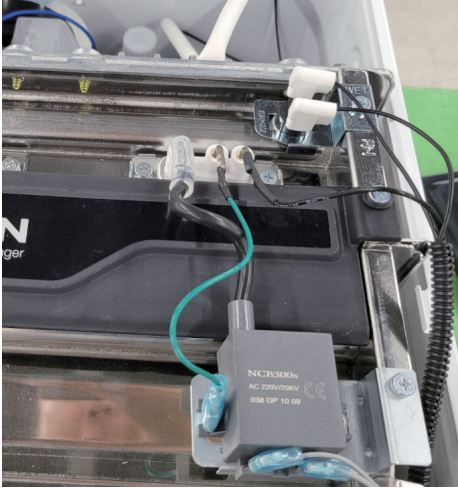
Testing method

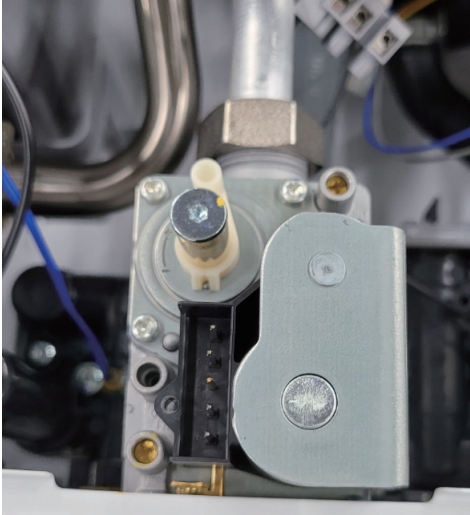
Error type	Cause	Testing method
Ignition failure	Gas supply fault	<ol style="list-style-type: none"> 1. Check if the main gas valve is open. 2. Check the gas supply pressure. <ul style="list-style-type: none"> • NG: 17-25 mbar, LP: 25-35 mbar • LP pressure drops can occur during winter. 3. Check the diameter of the flexible pipe to ensure it is compatible with the boiler. 4. If a CSST connector is used, ensure that it has not been overtightened. An overtight connection can deform the seal and obstruct the flow of gas. 5. Check the class of pressure meter.
		<div style="display: flex; justify-content: space-around; align-items: center;"> <div style="text-align: center;">  <p>Digital pressure manometer</p> <p>Check gas supply pressure</p> </div> <div style="text-align: center;">  <p>Deformed seal can obstruct the internal diameter of CSST connectors</p> </div> </div>
	Electrode gap and shape faults	<p>Insufficient electrode gap and deformed electrodes can prevent ignition.</p> <ul style="list-style-type: none"> • Recommended gap: approx. 3-4 mm (1/8"). Replace electrode if defective. • Ignition can fail due to improper gap even if the discharge appears normal in the flame monitoring window. Disassemble to gain access to the electrode and inspect the gap.

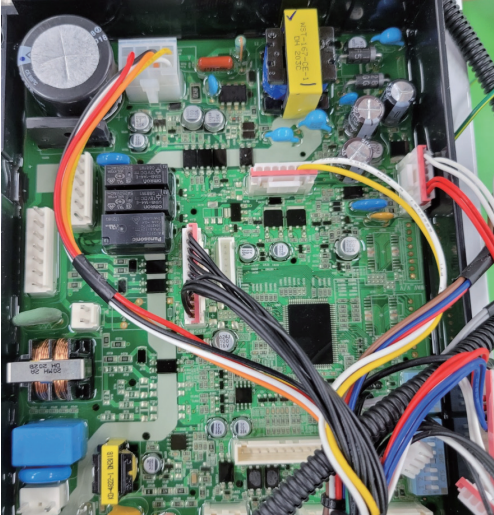
Error type	Cause	Testing method
		 <p data-bbox="756 734 1046 763">Ignition gap: 3.5-4.5 mm (1/8")</p>
Ignition failure	No spark from the electrode	<p data-bbox="619 797 1177 826">When no discharge is seen at the electrode during ignition:</p> <ul data-bbox="619 831 1426 1055" style="list-style-type: none"> • Remove the electrode and check for cracks in the insulator. • Adjust the gap if discharge is visible. • Ensure that the insulating gasket is fitted between the electrode and burner casing. • Check the input voltage at the ignition transformer (AC 230 V). • If the voltage is correct, replace the ignition transformer. • If there is no or low voltage at the ignition transformer, replace the PCB. • Check the insulator boots on the spark leads for cracks or holes.
		 <p data-bbox="804 1610 999 1639">Ignition transformer</p>

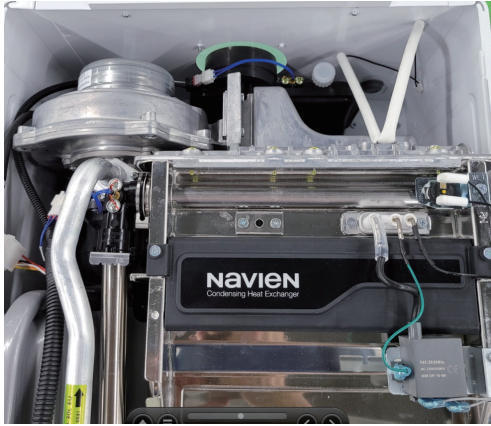
Error type	Cause	Testing method
Ignition failure	Main gas valve	<ol style="list-style-type: none"> 1. Test the primary and secondary voltages at the main gas valve. <ul style="list-style-type: none"> • Use a multimeter, between the YELLOW - WHITE wires and verify the voltage is DC 24 V 2. If there is no voltage, replace the PCB. 3. If the voltage is correct, check if the coil is open. <ul style="list-style-type: none"> • Check the resistance. Check if the solenoid valve works correctly. • Feel or listen for a click.
		<div style="display: flex; justify-content: space-around;">   </div> <p style="text-align: center;">Check that the coil is open (Correct resistance range: 100-1,000Ω)</p> <div style="text-align: center;">  <p style="text-align: center;">Check the voltage at the solenoid valve / Yellow - White</p> </div>

Error type	Cause	Testing method
Repeated ignition failure	Flame error	<ol style="list-style-type: none"> 1. Inspect the flame area for deformation or foreign deposit. Repair or replace the part. 2. Check that the flame rod wiring connections are secure and free from damage. 3. Check the boiler case grounding connection is connected and secure. <ul style="list-style-type: none"> • If the ground wire is not adequately connected, remove and reattach the ground wire to ensure there is good contact with the case. • Use a multimeter to test the spark current (normally 3-4 μA).
	 <p>Test the spark current connectors</p>	 <p>Ground connection</p>
Flame loss and noise occurs at ignition	Check for obstructions in the gas orifice plate.	<p>Ignition failure can occur if the gas orifice is obstructed.</p> <ul style="list-style-type: none"> • Remove the gas inlet pipe and check the orifice plate.
Improper air intake air supply	Rainwater ingress	Check if rainwater has accumulated inside the unit boiler through an incorrectly installed air intake pipe.
Other faults	PCB fault	If the error condition continues after checking these items, replace the PCB.

5.2.3 Error 004

Error Conditions and Checklist

Error	Description
E004 False-flame detection	<ol style="list-style-type: none"> 1. Pre ignition false-flame 2. If a flame signal is detected continuously for 3 sec before combustion (stand-by, pre-purge, pre-ignition), a false-flame error 004E (automatically cleared) is displayed on the front panel. The system performs a continuous post-purge and starts the circulation pump. 3. Post purge false-flame 4. If a flame signal is detected continuously for 3 sec when the system performs post-purge after the gas supply closes, a false-flame error 004E (automatically cleared) is displayed on the front panel. The system performs a continuous post-purge and starts the circulation pump.
Checklist	<ol style="list-style-type: none"> 1. Check for gas leaks and defective seals on the main gas valve. 2. Check if a spark of sufficient intensity is discharged by the electrode. 3. Check if gas is supplied within the correct pressure range. 4. Check the PCB and replace it if faulty.

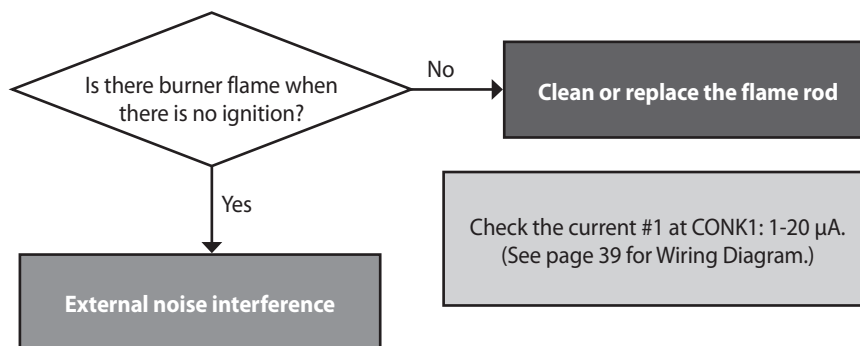

Testing method

Error	Cause	Testing method
Flame before/ after combustion	Main gas valve leak	If flame occurs before ignition or if gas continues to burn after combustion stops, replace the flame rod.
Error before/after combustion	Electrode level of discharge	Spark discharges from electrode to flame sensor at ignition. <ul style="list-style-type: none"> • Replace or correct the position of the flame rod.
	Gas valve	Gas may leak from the main gas valve if the gas supply pressure exceeds the boiler specifications. <ul style="list-style-type: none"> • Check the supply pressure: NG: 17-25 mbar, LP: 25-35 mbar. • If gas pressure is too high, notify the gas supplier and if necessary, replace the gas valve. • If there is a gas leak, close the gas supply valve and repair the unit before using the system.
Other faults	PCB fault	If the error condition continues after checking these items, replace the PCB.

5.2.4 Error 012

Error Conditions and Checklist

Error	Description
E012 Loss of flame	If the system detects a loss of flame during combustion, the system stops the gas supply and attempts to restart. Then, the system adds the instance to the flame loss count. If flame loss occurs 20 times consecutively, error code 012E is displayed (manually cleared) on the front panel.
Checklist	<ol style="list-style-type: none"> 1. Use a manometer to measure the gas supply pressure (NG: 17-25 mbar, LP: 25-35 mbar) 2. Check the gas meter rating. 3. Check if the gas orifice is obstructed. 4. Check if the PCB is working correctly.

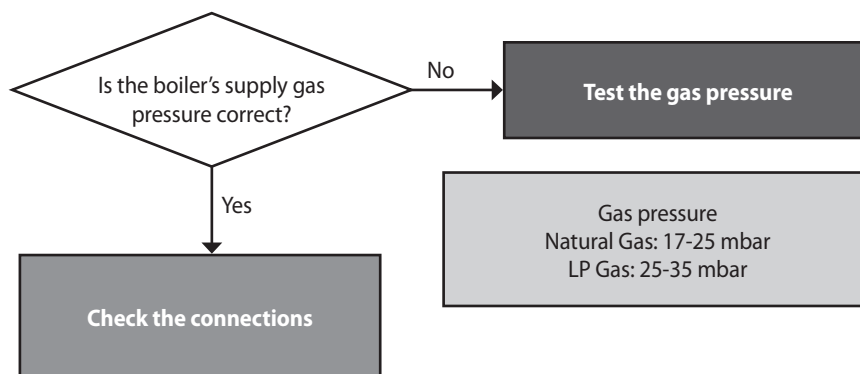

Testing method

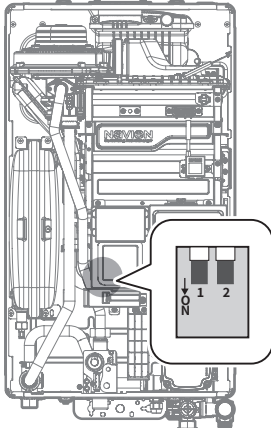
Fault	Possible causes	Testing method														
Flame loss and noise occurs after ignition	Low gas supply pressure	<ol style="list-style-type: none"> 1. Check the gas supply pressure. <ul style="list-style-type: none"> • NG: 17-25 mbar, LP: 25-35 mbar • LP pressure drop occurs frequently during winter. 2. When static pressure is normal, the use of other gas appliances may cause the boiler's gas pressure to drop. Check the dynamic pressure. Check the static pressure: Gas supply pressure in standby mode. Check the dynamic pressure: Gas supply pressure at maximum combustion. 3. Check the gas pipe connections. <ul style="list-style-type: none"> • If a CSST connector has been used, ensure that it has not been overtightened. An overtight connection can deform the seal and obstruct the flow of gas. 4. Check the gas meter rating. 														
Flame loss and noise occurs after ignition	PCB DIP switch setting error	<p>Check the PCB DIP switch settings.</p>  <table border="1" data-bbox="687 1350 1433 1554"> <thead> <tr> <th>Switch</th> <th>Function</th> <th colspan="2">Setting</th> </tr> </thead> <tbody> <tr> <td rowspan="4">1 & 2</td> <td rowspan="4">Fuel selection</td> <td>LNG(G20)</td> <td>1-OFF, 2-OFF</td> </tr> <tr> <td>Not Used</td> <td>1-OFF, 2-ON</td> </tr> <tr> <td>LPG(G30)</td> <td>1-ON, 2-OFF</td> </tr> <tr> <td>LPG(G31)</td> <td>1-ON, 2-ON</td> </tr> </tbody> </table>	Switch	Function	Setting		1 & 2	Fuel selection	LNG(G20)	1-OFF, 2-OFF	Not Used	1-OFF, 2-ON	LPG(G30)	1-ON, 2-OFF	LPG(G31)	1-ON, 2-ON
Switch	Function	Setting														
1 & 2	Fuel selection	LNG(G20)	1-OFF, 2-OFF													
		Not Used	1-OFF, 2-ON													
		LPG(G30)	1-ON, 2-OFF													
		LPG(G31)	1-ON, 2-ON													
Flame loss during Stage 2	Blockage in the gas orifice plate.	<p>Flame loss will occur if the gas orifices in the dual venturi are clogged.</p> <ul style="list-style-type: none"> • Remove the gas inlet pipe and check for debris inside the dual venturi. Remove and clean the orifice plate if necessary. 														
Other faults	PCB DIP switch setting errors	<p>Check the PCB DIP switch settings. * Check the correct resistance for flame detection AD.</p>														
	PCB fault	<p>If the error conditions continue after checking these items, replace the PCB.</p>														

5.2.5 Error 016

Error Conditions and Checklist

Error	Description
E016 Bi-metal overheated	If the overheat controller on the heat exchanger is initiated during boiler combustion or standby, the system displays 016E (manually cleared) on the front panel. The boiler switches to Lock-out mode and performs a continuous post-purge and starts the circulation pump.
Checklist	<ol style="list-style-type: none"> 1. Check the overheat controller is working correctly. *Test the resistance or continuity. 2. Check the hot water temperature sensor. 3. Test the circulation pump's supply voltage (AC 230 V). 4. Test the resistance at the pump.

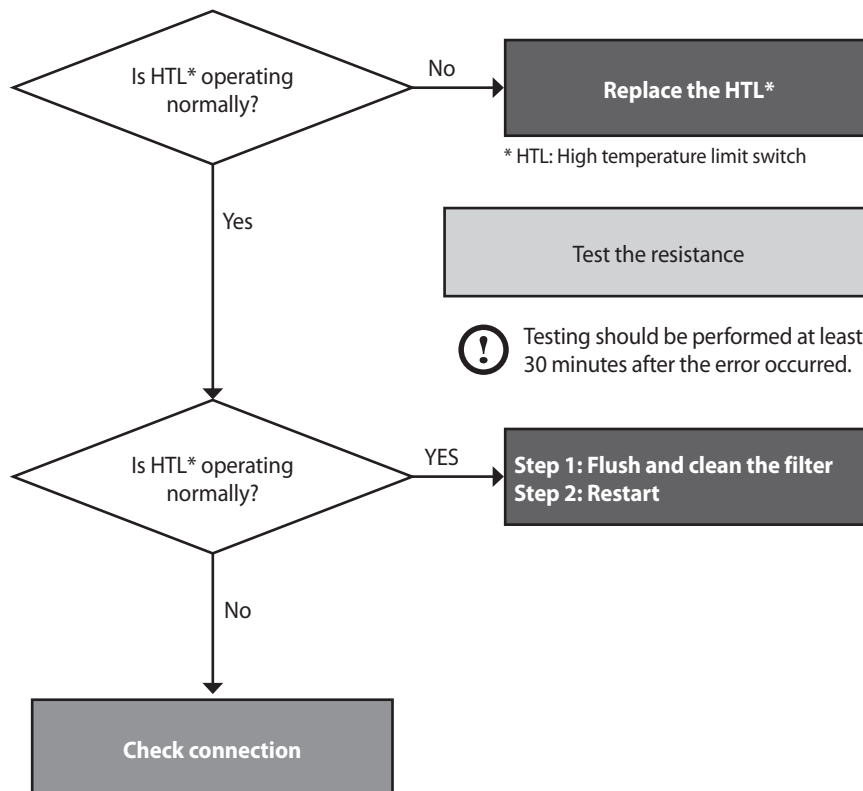

Testing method

Fault	Possible Causes	Testing method
Defective safety device	Defective overheat controller	Check if the overheat controller's contacts are faulty. <ul style="list-style-type: none"> • Use a multimeter to test the resistance. Normal resistance is 0.3Ω and a fault condition would be infinity (∞).
		<div data-bbox="737 504 1139 1037" data-label="Image"> </div> <p data-bbox="842 1048 1034 1075" style="text-align: center;">Overheat controller</p> <p data-bbox="427 1097 1157 1124">Check if the overheat control wiring is disconnected (normal resistance: 0.3Ω)</p>
Temperature sensor error	DHW output temperature sensor error	<ol style="list-style-type: none"> 1. If the hot water temperature is measured at levels lower than it actually is, test to confirm if the temperature sensor is faulty. <ul style="list-style-type: none"> • Check the output temperature displayed on the front panel. 2. Measure the temperature sensor resistance, and determine if the sensor is faulty.
Other potential issues	Capacity setting	<ol style="list-style-type: none"> 1. If the Max switch is ON, change the switch to the normal operating position. 2. PCB DIP switch capacity setting errors can result in sudden increases to DHW temperature.
	Primary heat exchanger overheat	The surface temperature rises due to heavy scale deposits in the primary heat exchanger. <ul style="list-style-type: none"> • Flush the primary heat exchanger.
	PCB fault	If the error condition continues after checking these items, replace the PCB.

5.2.6 Error 030

Error occurrence conditions and check items

Error	Description
<p style="text-align: center;">E030 Exhaust gas temperature error</p>	<p>If the overheat controller on the top of the exhaust duct is initiated, the system displays the heat exchanger bimetal overheat message 030E (cleared manually) on the front panel. The boiler switches into Lock-Out, and performs post-purge continuously and operates the pump. Overheating controller operates when the temperature exceeds 110°C for 10 minutes or over.</p> <ol style="list-style-type: none"> 1. When the controller detects the exceeding temperature of 110°C for 10 minutes or more E030 is displayed and a post-purge will be performed. → Automatically cleared. 2. When the controller detects the exceeding temperature of 60°C while performing post-purge. → Manually cleared. 3. When the controller detects the exceeding temperature of 110°C for 10 seconds or over three times or more after the error is automatically cleared. → Manually cleared.
<p style="text-align: center;">Checklist</p>	<ol style="list-style-type: none"> 1. Check if the overheat controller operates normally. 2. Check if the PCB works properly.

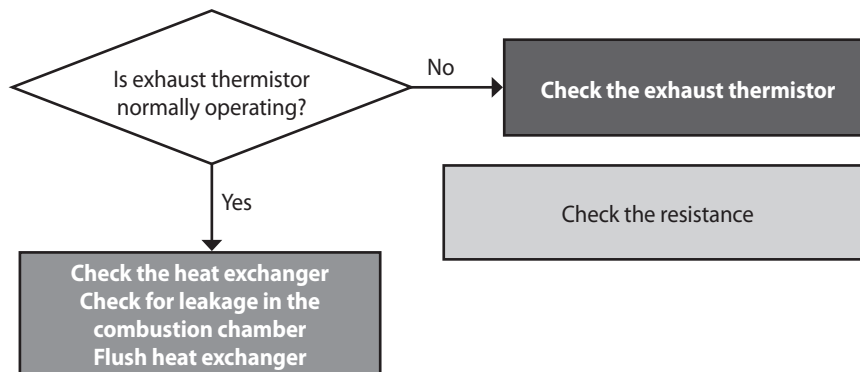

Testing method

Fault	Possible causes	Testing method
Heat exchanger overheat	Damaged or obstructed heat exchanger	<ol style="list-style-type: none"> 1. High exhaust gas temperatures can cause damage to or obstruct the heat exchanger. 2. Flush the heat exchanger to remove scale deposits. 3. Replace the heat exchanger if it is damaged or cannot be unlogged.
Defective part	Defective overheat controller	Faulty terminals on the exhaust gas overheat controller (110°C max) <ul style="list-style-type: none"> • Check the overheat controller's wiring connections. • If the resistance is incorrect, replace the temperature sensor. • Check the output temperature displayed on the PCB.
	 <p>Test if the hot water temperature sensor is open (error result: MΩ open)</p>	
Other faults	PCB fault	If the error condition continues after checking these items, replace the PCB.

5.2.7 Error 031

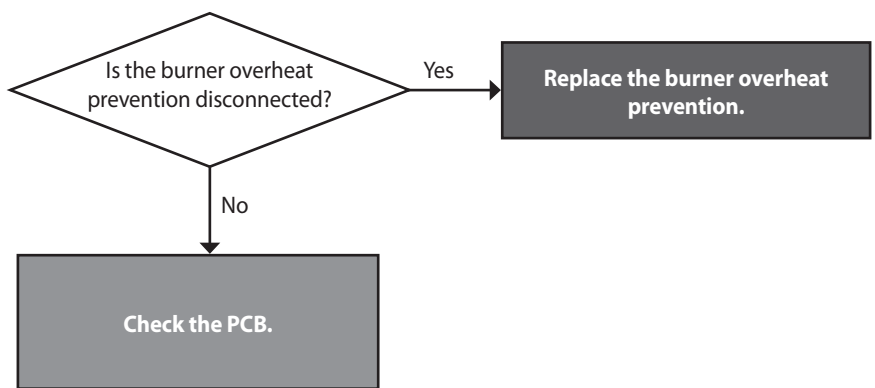

5.2.8 Error 046

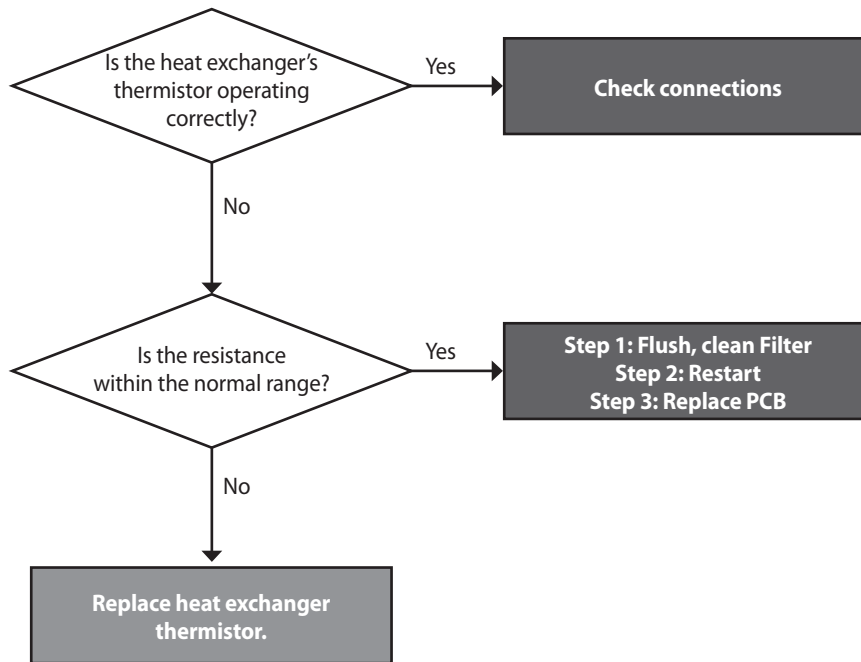

5.2.9 Error 047

Error Conditions and Checklist

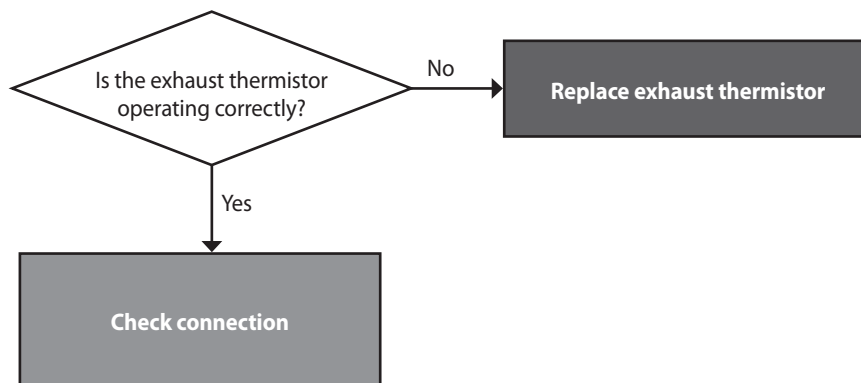

5.2.10 Error 109

Error occurrence conditions and check items

Error	Description
<p>E109 Fan motor speed error</p>	<p>The system checks the fan speed signal when the fan starts. The error message 109E (cleared manually) is displayed in the following cases:</p> <ol style="list-style-type: none"> 1. If fan speed is low or close to 0, the system detects a speed error and the boiler switches to Lock-out mode (gas valve and ignition transformer locked). The air pressure sensor should be normal. 2. If a low speed signal or one that is close to 0 is detected for 3 sec during combustion, the system stops combustion and the boiler switches to Lock-out mode. The air volume sensor should be normal.
<p>Checklist</p>	<ol style="list-style-type: none"> 1. Check if the fan motor works normally using the component test mode. 2. Test the power supply to the fan (Black + Yellow, DC 340 V) 3. If the speed is very low while the fan operates and the power supply is normal, replace the fan motor. 4. If the fan connector is wet for any reason, turn off the boiler, prevent further water ingress and dry the components completely before resuming operation. 5. Check that the connection between the fan motor and the PCB is secure.

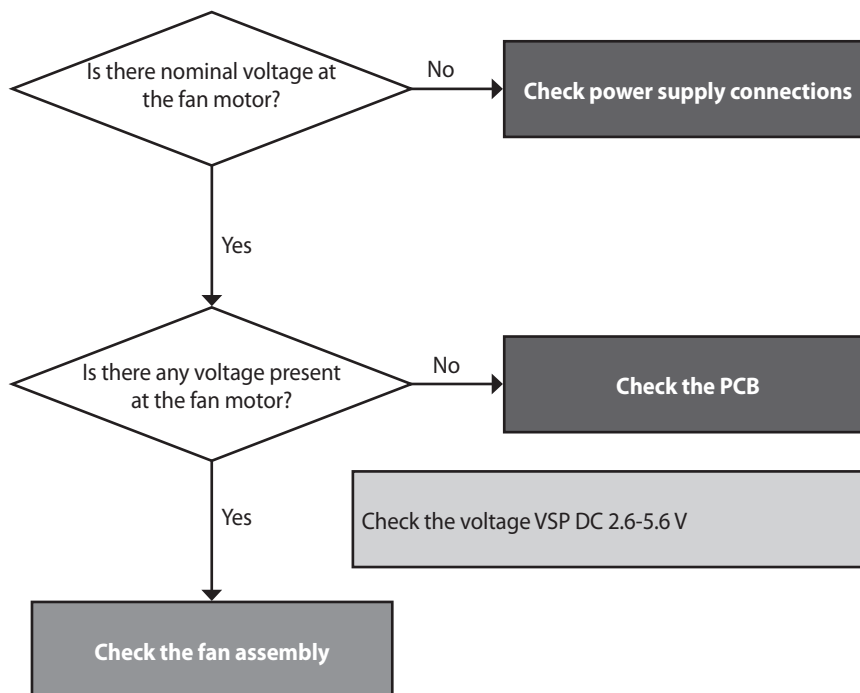

Testing method

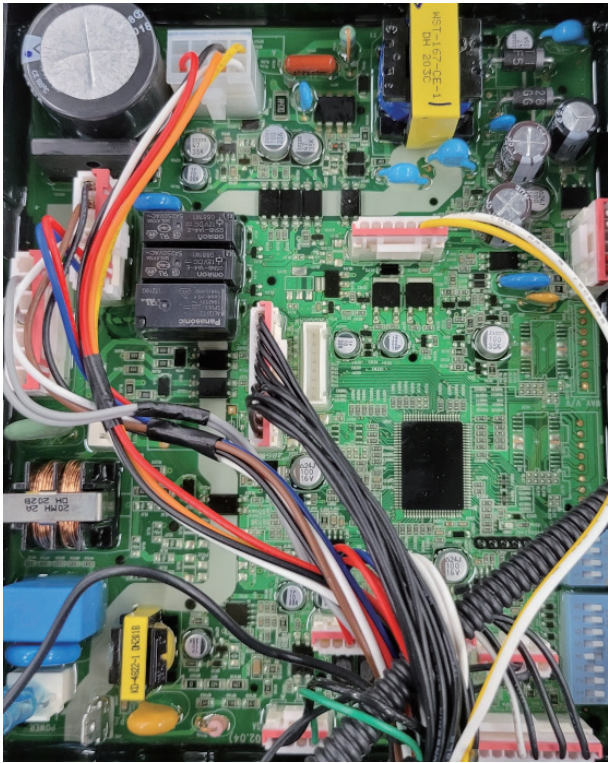
Fault	Possible Causes	Testing method
Fan action error	No fan operation	<ol style="list-style-type: none"> 1. Check the voltage at the fan. <ul style="list-style-type: none"> • Black + Yellow, DC 340 V 2. Replace the PCB if the voltage is not present. When replacing a PCB, turn off the boiler and wait for at least 10 sec before proceeding. 3. If the error condition continues after checking these items, replace the fan motor.
		<div style="text-align: center;">  </div> <p style="text-align: center;">Check the fan motor's wiring connection</p>
Fan motor speed error	Rotation fault	<ol style="list-style-type: none"> 1. If fan speed is very low and the power supply is normal, follow the instructions below to replace the fan. <ol style="list-style-type: none"> 1) Unplug the boiler's power cable and wait 10 sec for all remaining SMPS voltage to completely discharge. 2) Disconnect the fan cable and then re-connect it. 3) Reconnect the power cable and turn on the boiler. 4) Fan Auto Adjusting verifies error conditions for error code E109. If an E109 error occurs, enter Fan test mode and verify fan speed and the APS input voltage. (Eg. The display will show H.320 indicating 3,200 rpm) 5) If fan speed is low or there is a sensor circuit error, replace the fan. This condition indicates an imminently hazardous situation which, if not avoided, may result in minor or moderate injury. 2. If the error condition continues after checking these items, replace the PCB.

5.2.11 Error 205

Error conditions and checklist

Error	Description
E205 Heat exchanger output temperature sensor open	If an error (open: -10°C or lower) in the heat exchanger input temperature sensor is detected, the system displays 205E on the front panel. If this occurs, the boiler shuts down.
Checklist	<ol style="list-style-type: none"> 1. Check if the heat exchanger output temperature sensor connector is wet due to any reason, including leakage. 2. Replace the defective heat exchanger output temperature sensor. 3. Check the circulation pump's operating status and the flow rate in the space heating lines. 4. Test the voltage at the PCB to verify the correct voltage at the pump. If there is no voltage, vent the air from the system before resetting the unit. If the error condition persists, replace the pump.

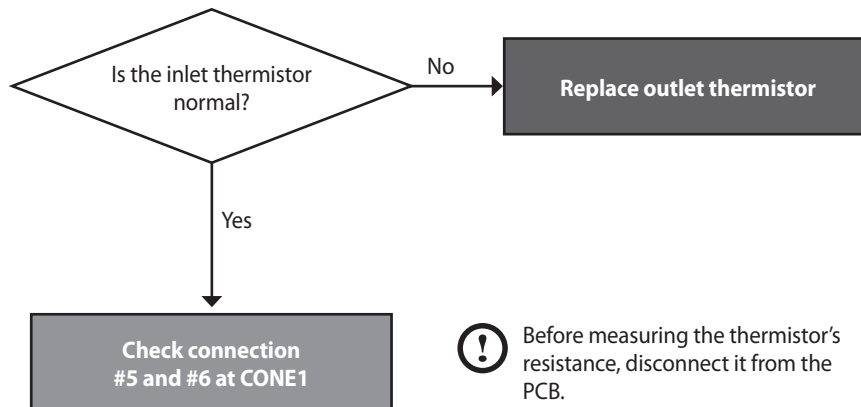

Check method

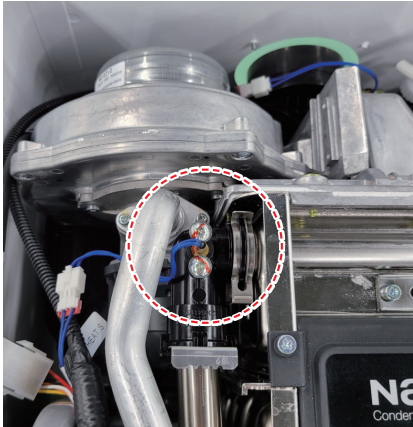
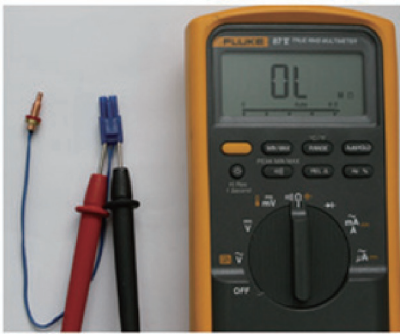
Fault	Possible causes	Testing method
Faulty sensor	Temperature sensor connection fault	Check if the temperature sensor is open and if the connector is connected properly.
	Temperature sensor fault	Test the resistance of the temperature sensor. The sensor is faulty if the resistance is 30kΩ or higher. <ul style="list-style-type: none"> • Replace the temperature sensor if the resistance value is abnormal. • Check the temperature displayed on the front panel.
Possible Issues	Circulation pump fault	Test the voltage at the circulation pump (AC 230 V).
	PCB fault	If the error condition continues after checking these items, replace the PCB.
<div style="text-align: center;">  <p data-bbox="667 1146 1216 1178"><Heat exchanger output temperature sensor / connector></p>  <p data-bbox="517 1590 1362 1621">Test to confirm if the secondary water temperature sensor is open. Error: MΩ open circuit.</p> </div>		

5.2.12 Error 218

Error conditions and checklist

Error	Description
E218 Open heat exchanger input temperature sensor	If an open (-10°C or lower) heat exchanger input temperature sensor is detected, the system displays 218E on the front panel. If this occurs, the boiler initiates shutdown.
Checklist	<ol style="list-style-type: none">1. Check if the heat exchanger input temperature sensor connector is wet due to any reason, including leakage.2. Replace the defective heat exchanger input temperature sensor.3. Replace the controller.

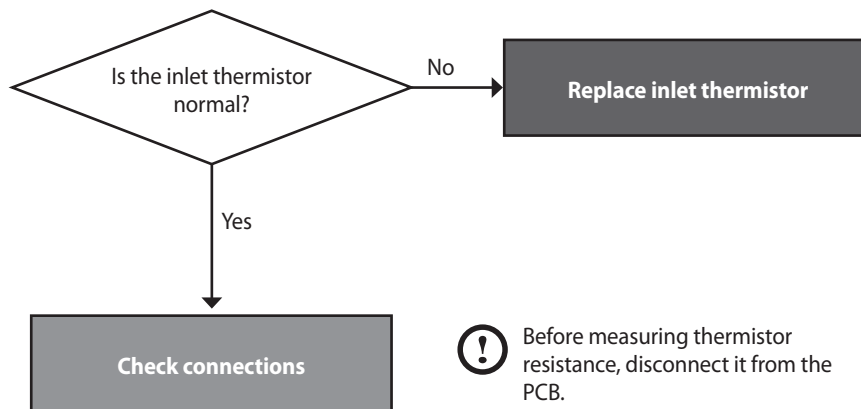

5.2.13 Error 302

Error conditions and checklist

Error	Description
E302 Low water pressure	Low pressure faults are monitored by a water pressure sensor and when a fault is detected the system displays E302 Low water level error is generated if water pressure is 0.5 bar or less for 3 sec. The error is automatically cancelled if water pressure returns to 0.5 bar or above.
Checklist	<ol style="list-style-type: none"> 1. Check if the input water pressure sensor is wet for any reason, including leakage. 2. Check the auto feeder. 3. Check the controller.

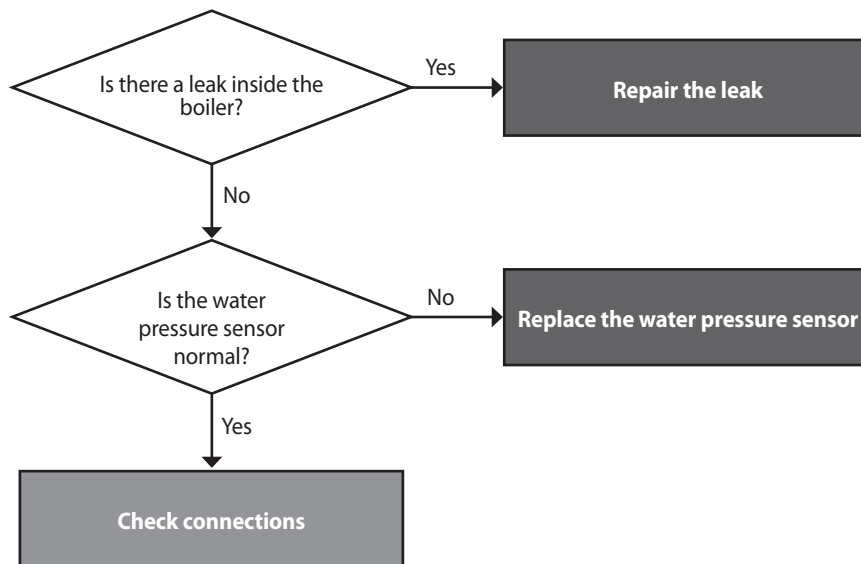

Testing method

Fault	Possible causes	Testing method
E302	Low water pressure	Check the water supply pressure (0.5 bar or lower is the error state). Check if the safety valve is stuck.
Low water pressure sensor	Water pressure sensor fault	<ol style="list-style-type: none"> 1. Check the output voltage. (Normal state: 0.25-4.93 V) 2. Replace the faulty or open water pressure sensor.

5.2.14 Error 352

Error conditions and checklist

Error	Description
E352 High water pressure	If an error signal is received from the water pressure sensor, the system displays the E352 on the front panel. High water pressure errors occur if the water pressure is 3.9 bar or higher for 3 sec. The error is automatically cancelled if the water pressure returns to 3.9 bar or lower.
Checklist	<ol style="list-style-type: none"> 1. Check if the input water pressure sensor is wet for any reason, including leakage. 2. Check the controller.

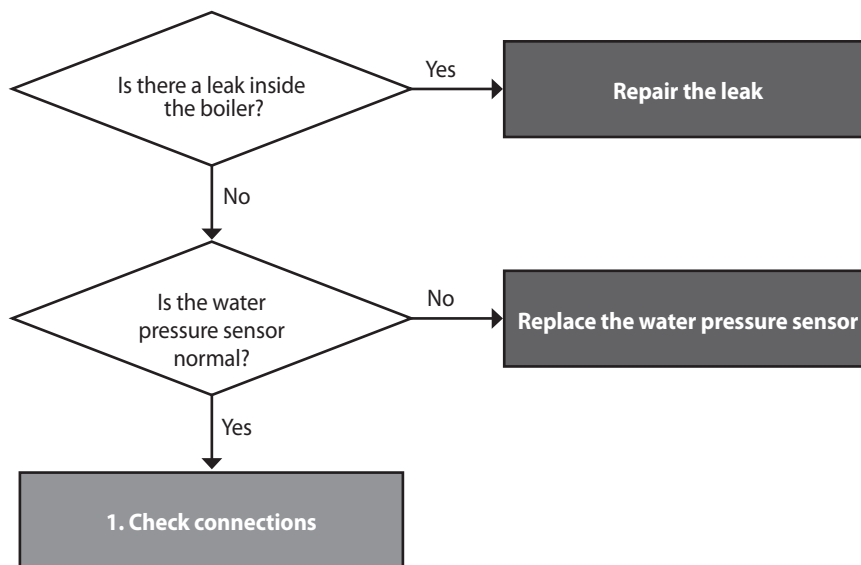

Testing method

Fault	Possible causes	Check method
E352	High water pressure	Check the water supply pressure. (3.9 bar or higher is the error state) Check if the safety valve is stuck. Check the Auto feeder valve.
High water pressure sensor	Water pressure sensor fault	<ol style="list-style-type: none"> 1. Check the output voltage. (Normal state: 0.25-4.93 V) 2. Replace the faulty or open water pressure sensor.

5.2.15 Error 353

Error conditions and checklist

Error	Description
E353 Water pressure sensor fault	If a voltage error (< 0.3 V or > 5 V) at the water pressure sensor is detected continuously for 3 sec, the system displays E353. When this error occurs, the boiler shuts down.
Checklist	<ol style="list-style-type: none"> 1. Check if the input water pressure sensor is wet due to any reason, including leakage. 2. Replace the water pressure sensor. 3. Check the controller.

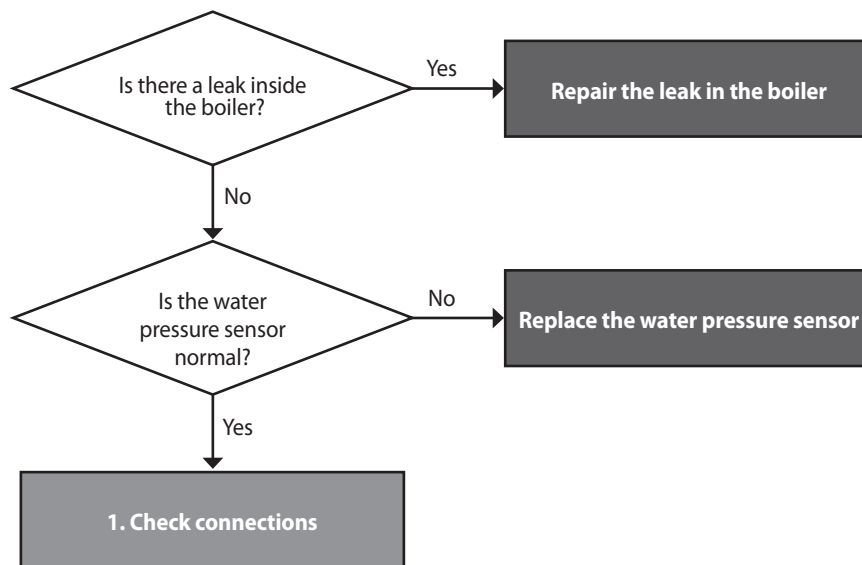

Testing method

Fault	Possible causes	Testing method
Water pressure sensor fault	Water pressure sensor fault	<ol style="list-style-type: none"> 1. Check if the sensor is frozen. 2. Check the output voltage. (Normal state: 0.25-4.93 V) 3. Replace the PCB if the voltage is not correct.

5.2.16 Error 515

Error occurrence conditions and check items

Error	Description
E515 error	If an error occurs in the internal circuit of the PCB (e.g., resistance, transistor or relay fault), the system displays 515E (cleared manually) on the PCB.
Check items	<ol style="list-style-type: none"> 1. Defective PCB 2. Check with a multimeter if the PCB is supplied with the proper voltage (AC 230 V). 3. Check the wire connection. 4. Disconnect the ground wire, then check the PCB.

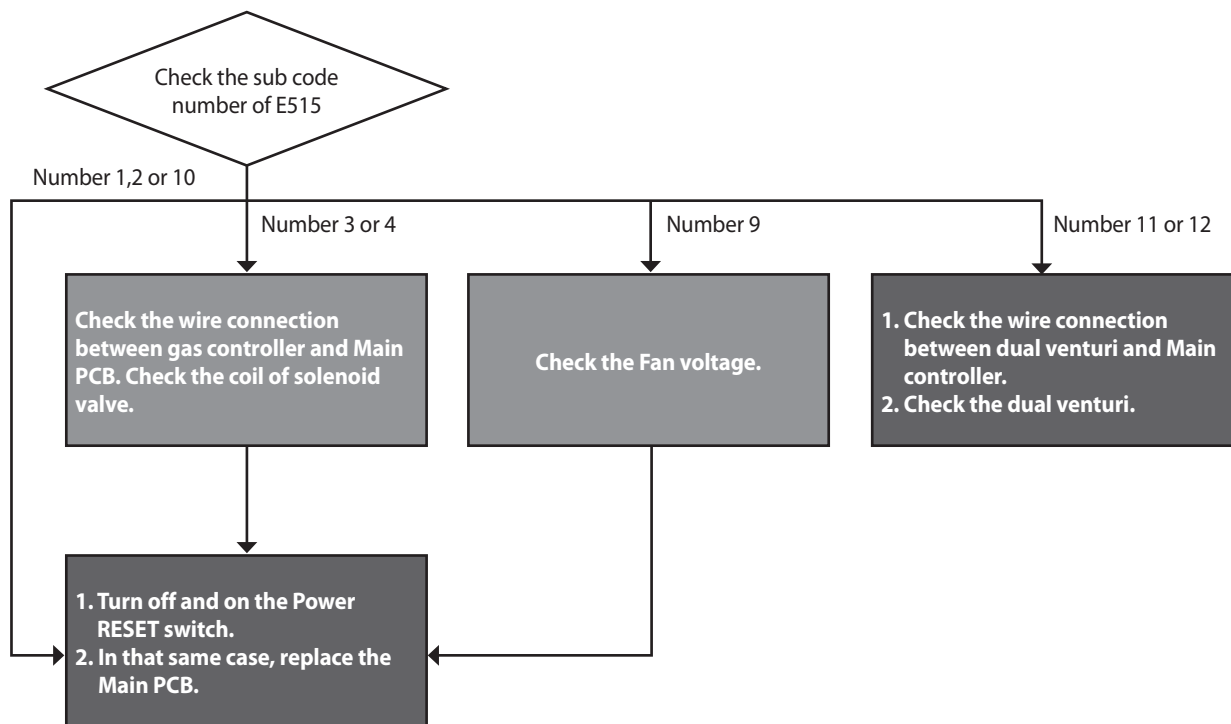

Check Method

Fault	Possible Causes	Check method
PCB or Electrical supply	Defective PCB	Replace the PCB if there is an error with the PCB internal circuit.
	Power supply error	Check with a multi-meter if the PCB is supplied with the proper voltage. <ul style="list-style-type: none"> • Check with a multi-meter if the voltage at the electrical outlet is AC 230 V.
	Power supply grounding noise	Power supply grounding noise causes malfunction. <ul style="list-style-type: none"> • Disconnect ground from the grounding terminal inside the unit, and check if the PCB is operating normally.

5.2.17 Error 517

Error occurrence conditions and check items

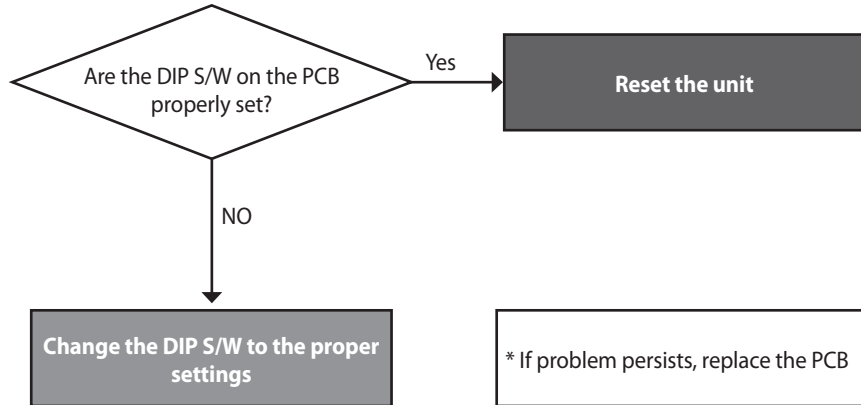

5.2.18 Error 593

Error occurrence conditions and check items

Error	Description
E593 error	If the Touch IC IIC Communication is not available for more than 1 minute, the system displays the error message E593 on the front panel. The error will be automatically released when normal operating conditions are met.
Check Items	1. Reset the unit. 2. If the system still displays E593, replace the front panel.

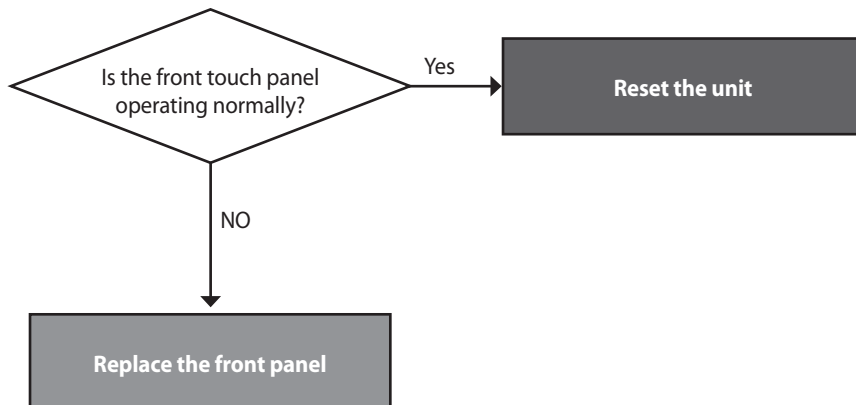

5.2.19 Error 594

Error occurrence conditions and check items

Error	Description
E594 error	If the communication is abnormal in parts of PCB, the system displays E594 on the PCB.
Check items	Check the PCB.

Error occurrence conditions and check items

Fault	Possible Causes	Check method
E594 Error	Abnormal communication by PCB.	<ol style="list-style-type: none">1. Click the Reset button on Front panel.2. Turn the POWER to the unit OFF then ON. Disconnect then reconnect power if necessary.3. If the system still displays E594, replace the main PCB.

5.2.20 Error 615

Error occurrence conditions and check items

Error	Description
E615 error	Abnormal signal input by PCB.
Check items	<ol style="list-style-type: none">1. Turn the POWER RESET switch OFF then ON (or unplug and then reconnect the power supply).2. If the system still displays E615, replace the main PCB.

5.2.21 Error 740

Error conditions and Check Items

Error	Description
E740 Abnormal outdoor sensor	If an error (under 2.2kΩ or over 122.2kΩ) in the outdoor sensor is detected continuously for 3 seconds, The system displays the error message E740 on the front panel. If this occurs, the boiler changes the control mode from Reset Curve Mode to Normal Mode.
Check items	<ol style="list-style-type: none"> 1. Check the parameter setting. 2. Check the outdoor sensor.

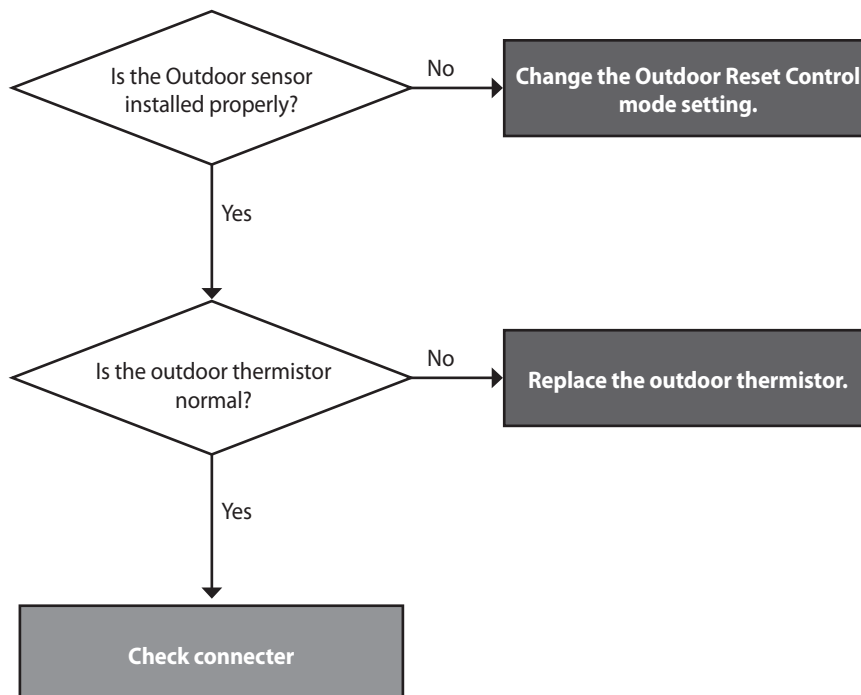

5.2.22 Error 782

Error occurrence conditions and check items

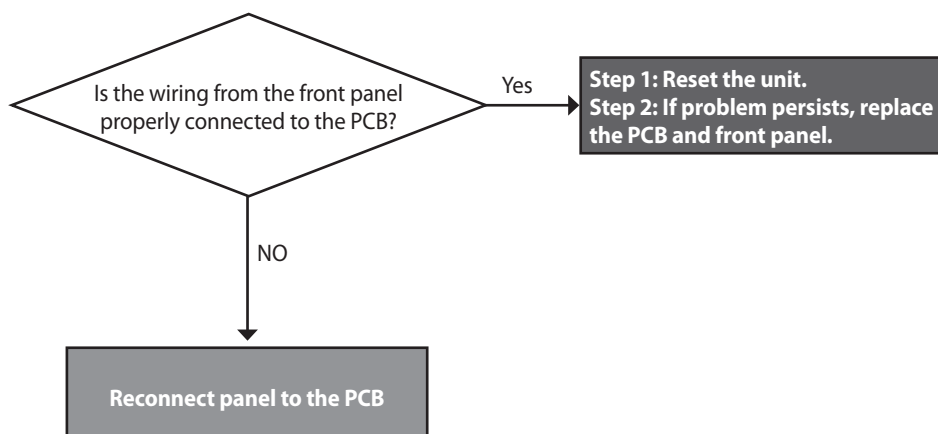

5.3 Troubleshooting guide by symptom

5.3.1 Noise

Error type	Cause	Check method
Vibration noise	Defective installation	<p>Incorrect mounting to the wall or in an improper location.</p> <ul style="list-style-type: none"> • Check for improper installation and reinstall the unit if necessary.
	Fan vibration noise	<p>Vibration caused due to defective blower.</p> <ul style="list-style-type: none"> • Check the blower. If vibration is significant, replace the fan. • If intermittent noise occurs during operation, check the fan for debris. • If vibration noise occurs during operation of the product, and stops when the case lid is removed, check the fan.
Noise at ignition	Gas and air differential pressure error (Pop, Beep, Explosive ignition)	<ol style="list-style-type: none"> 1. Offset pressure adjustment error. <ul style="list-style-type: none"> • Adjust offset pressure with the pressure adjusting screw on the main gas valve. • Use the Front Panel to set the unit at "MIN.1". • If noise occurs at standard value, adjust setting above / below the standard. 2. Gas supply error due to defective air pressure sensor. 3. If the same error is repeated, it is due to a defective PCB.
Noise during combustion	Boiling noise	<ul style="list-style-type: none"> • How to check boiling: • The heat exchanger is clogged partially due to scale deposits. Flush the main heat exchanger to remove scale. • Replace the heat exchanger if the error occurs from the start of the installation.
	Whirring	<p>Exhaust gas that is recirculated into the boiler through the air inlet could produce abnormal combustion noises.</p> <ul style="list-style-type: none"> • Check the distance between intake and exhaust (at least 12" (300 mm)). • Check the distance between flues if two or more units are installed (at least 12" (300 mm)). • Check if there are any obstructions near the flue.
	Low gas pressure (whirring)	<ol style="list-style-type: none"> 1. Noise occurs due to low gas pressure. <ul style="list-style-type: none"> • Check the gas supply pressure (dynamic pressure). 2. Low gas supply due to offset pressure error. <ul style="list-style-type: none"> • Use the Front Panel to set the unit at "MIN.1".
		Noise due to defective air pressure sensor. <ul style="list-style-type: none"> • Replace the air pressure sensor.
Noise during combustion	<ul style="list-style-type: none"> • Noise due to damaged air pressure hose. • Noise may be intermittent depending on the size of the damage. 	

5.3.2 Water Temperature Issue

Error type	Cause	Check method
Boiler is not operating properly.	Front panel power off	Hot water does not run if the front panel is switched off.
	Defective hot water temperature sensor	The temperature is sensed higher than the actual temperature due to a defective hot water (cold water) sensor. <ul style="list-style-type: none"> Hot water temperature is low although hot water is recognised by the boiler. The cold water temperature sensor may not be working properly.
Low hot water temperature	Hot water setting error	Check the hot water temperature setting on the front panel.
	Water mixed with cold water.	The temperature of hot water at the tap is low while the temperature is high at the hot water outlet. <ul style="list-style-type: none"> Cold water and hot water are mixed due to improper pipe installation. Cold water and hot water are mixed due to improper piping at the hot water faucet.
No hot water from the valve	Check the pipe	<ol style="list-style-type: none"> The cold water valve is closed. Check if the cold water filter is clogged with foreign substance. Check if the cold water / hot water pipes are frozen during the winter. The main heat exchanger is clogged (by scale). Low inlet water pressure
Cold water flows temporarily	Pre-heating does not work	The system initiates the internal / external circulation preheating when a recirculation mode is selected on the front panel DIP switches. Confirm the DIP switch settings.

5.3.3 Circuit breaker operation

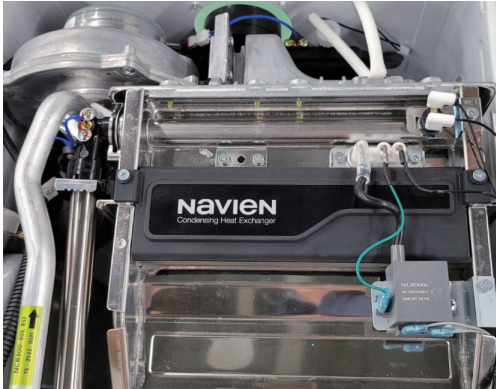
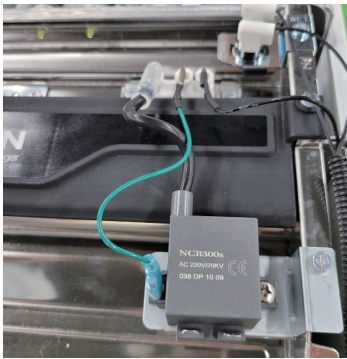
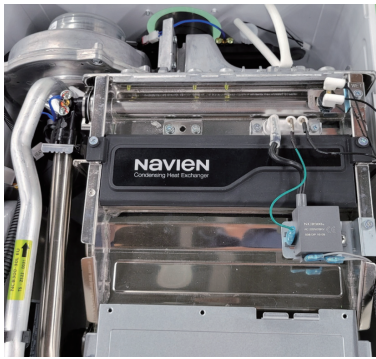
Error type	Cause	Check method
Defective sensor	Power supply	The circuit breaker trips immediately as soon as the power cord is plugged in the receptacle. Check the sheath of power cord, or if there is short-circuit. Check the components in order from the power transformer to the PCB.
	Defective part assembly	If the circuit breaker operates after repairs check the wiring of each part. Maintain proper direction when assembling the ignition transformer. Be careful that wire is not compressed when assembling the main gas valve Check if the wire is fixed and properly attached on the main side of the heat exchanger.
Circuit breaker trips	 <p>Normal assembly</p>	
	 <p>Short-circuit due to defective assembly</p>	 <p>Wiring near the heat exchanger</p>
	Circuit breaker operates while the boiler is running	If circuit breaker trips during the operation of the boiler, check the order of operation, and replace the concerned part. e.g., The circuit breaker operates at switchover to burner stage 2 after ignition. <ul style="list-style-type: none"> Replace the dual venturi.
Remote controller power	Check the wire	Check the power supply to the remote controller terminal. If there is a problem in power supply, check the output voltage of the PCB, and take the action separately for wiring error and defective PCB, respectively. If the power supply is normal, replace the remote controller.

6. Replacement of Parts

6.1 Replacement Procedure

⚠ CAUTION

1. When performing maintenance and/or servicing the boiler, always turn off the electric power, gas and water shut-off valve. Wait for the boiler to become cool. Be careful to avoid injury to your fingers on sharp edges.
2. Drain all water from the boiler when removing the waterway components.
3. Before any disassembly, make sure that all issues and error codes are properly diagnosed.
4. Handle all parts carefully.
5. When reassembling, prevent any foreign substance, i.e. dust, etc. from entering back into the boiler.
6. After reassembling, check for gas and water leakage. Then, test for proper ignition. Make sure that there is no gas leakage from the gas connections by testing with soap bubble solution. Bubbles indicate a gas leak that must be corrected.
7. Check the performance and operation after the boiler has been serviced.

To remove and replace any parts from the boiler, you will need a screwdriver that is at least 8-10 inches long. A flashlight and magnetic tip are also recommended. Navien recommends the use of a parts tray to hold small parts and screws. All of the hardware is essential to the proper operation of the unit upon re-assembly.

Note When disassembling and reassembling the boiler, refer the components diagram & parts list.

6.2 Components Replacement Instructions

6.2.1 PCB

1. Turn off the gas supply to the unit.
2. Disconnect the unit from the power supply.
3. Turn off the water supply to the unit.
4. Remove the six screws from bottom PCB bracket and upper PCB bracket.



Figure 1

5. Disconnect all wiring connectors from the PCB.

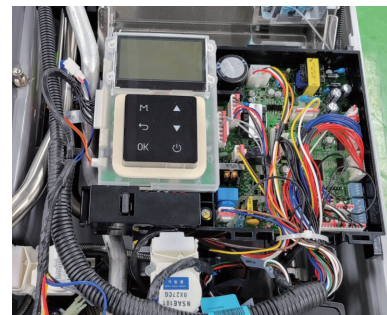

Figure 2

6. Remove the old PCB and replace it with the new part.
7. Reattach all wiring connectors to the PCB.
8. Set the proper DIP S/W settings on the PCB.
9. Reinstall the PCB and Front Panel using the three screws previously removed.

10. Turn on the water and gas supplies, then reconnect the power supply to the unit.

- Note**
- All wiring harness connections to the PCB should match in colour and pin types. Do not use excessive force when removing the connectors as this may cause damage to the PCB.
 - After replacing the controller, be sure to run the setup wizard and change to the existing setting.

11. When the boiler is turned on, press the Back button (←) and the Menu button (M) simultaneously for 3 seconds, and then select **"3. Parameter Settings"**.

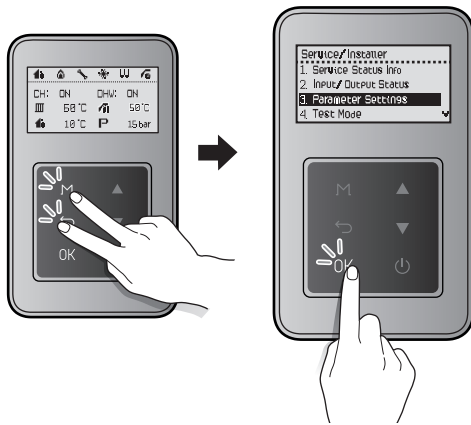

On the password screen, press the Up button (▲) and the Down button (▼) to change numbers and places, and press the OK button (OK) to enter the password.

The factory default password is "1234".



12. After entering the parameter setting screen, press the Up button (▲) or the Down button (▼) to select **"32. Factory Reset"** and press the OK button (OK) to proceed with the factory reset.

13. After the factory reset is completed, the setup wizard appears and set the following.

- Time setting: Set the current time. YYYY:MM:HH:MM:SS
- Gas type selection: Select **LNG(G20)**.
- Select the Heat demand: Select **3. Switched Live**. To use Smart Plus Controller, select **1. Navien Thermostat**.

- Note**
- If heating does not work even after installing the existing thermostat for heating adjustment after selecting **"3. Switched Live"**, check the wire connection to the controller terminal block again (Connect the thermostat to 5 and 6).

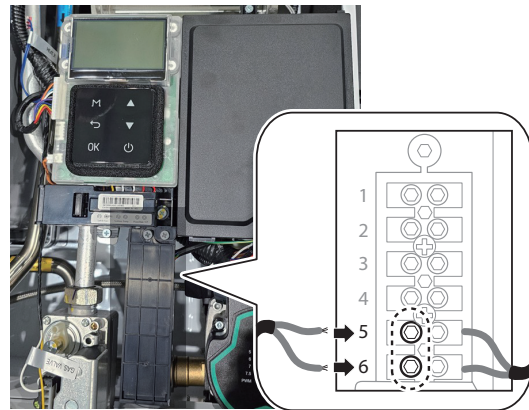

- DHW Preheat Usage: Select **External(NaviCirc)**.

6.2.2 Fuse

1. Turn off the gas supply to the unit.
2. Disconnect the unit from the power supply.
3. Locate the fuse housing shown in the figure below. Open the housing to expose the fuse.



Figure 3

4. Replace the fuse with a new fuse that is 5 mm in diameter, 25 mm long, and 3.12 amps.
5. Ensure that the new fuse is of an equivalent rating and that it is properly fixed inside the housing.
6. Close the fuse housing.
7. Turn on water supply, power supply, and gas supply to the unit.

6.2.3 Fan Motor (Combustion Air)

1. Turn off the gas supply to the unit.
2. Disconnect the unit from the power supply.
3. Turn off the water supply to the unit.
4. Remove the two mounting screws from the fan assembly as shown in Figure 4 below.
5. Remove the fan assembly bracket with the attached intake port.



Figure 4

6. Disconnect the wiring connector from the fan assembly, and then remove the two screws from the gas valve connection as shown in figure 5 below.



Figure 5

7. Pull out the fan assembly and remove the two screws that secure the air intake port to the fan assembly.

8. Remove the three screws from the bottom of the fan assembly.

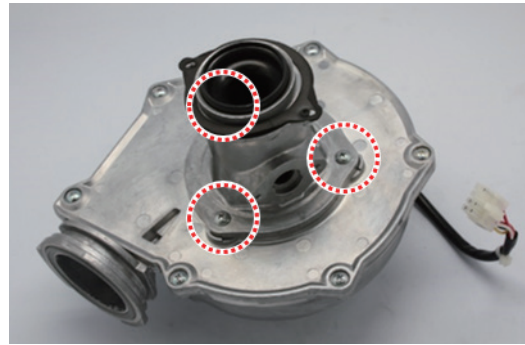

Figure 6

9. Detach the fan motor from the assembly and replace it with the new part.
10. Replace the three screws used to attach the fan motor to the assembly.
11. Reinstall the fan assembly to the bracket by using the mounting screw.
12. Attach the gas valve connection back to the fan assembly by using the three screws as shown in figure 6.
13. Reconnect the wiring connector from the fan assembly.
14. Turn on water supply, power supply, and gas supply to the unit.

Note Do not over-tighten the screws for the fan motor replacement with high torque drill. This may cause damage to the part(s).

6.2.4 Flame Rod

1. Turn off the gas supply to the unit.
2. Disconnect the unit from the power supply.
3. Turn off the water supply to the unit.
4. Remove the Ignition Transformer insulated cables.
5. Remove the two screws from the flame rod as shown in figure 7 below.

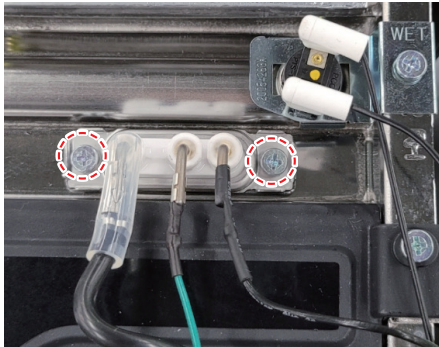

Figure 7

6. Remove the flame rod wiring connector.

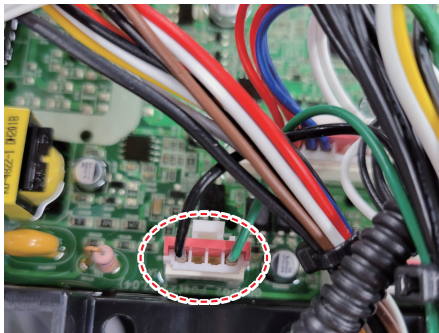

Figure 8

7. Remove the flame rod from the burner assembly and replace with the new part.
8. Reconnect the two ignition transformer insulated cables to the new flame rod.
9. Place the new flame rod back onto the burner assembly and secure it by using the two screws from figure 7.
10. Turn on water supply, power supply, and gas supply to the unit.

Note Always use new factory gaskets included with the flame rod when replacing the part onto the burner assembly.

6.2.5 Ignition Transformer

1. Turn off the gas supply to the unit.
2. Disconnect the unit from the power supply.
3. Turn off the water supply to the unit.
4. Remove the Ignition Transformer insulated cables from the flame rod.
5. Refer to figure 9 and disconnect the wiring connector from the Ignition Transformer.

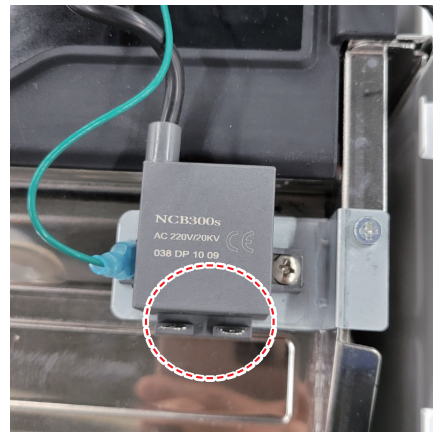

Figure 9

6. Remove the screw from the Igniter Transformer.

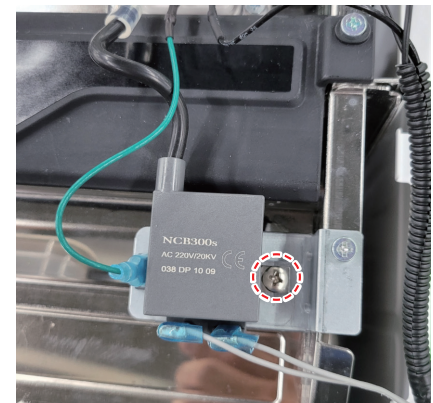

Figure 10

7. Pull out the Ignition Transformer.
8. Replace the old Ignition Transformer with the new part, and then use the two screws to secure the part.
9. Reconnect the Ignition Transformer insulated cables to the flame rod.
10. Reattach the wiring connectors from the Ignition Transformer.
11. Turn on water supply, power supply, and gas supply to the unit.

Note Verify that the Ignition Transformer insulated cables are firmly connected to the flame rod.

6.2.6 Main Gas Valve

1. Turn off the gas supply to the unit.
2. Disconnect the unit from the power supply.
3. Turn off the water supply to the unit.
4. Remove the two screws and disconnect the wiring connector at the gas valve.

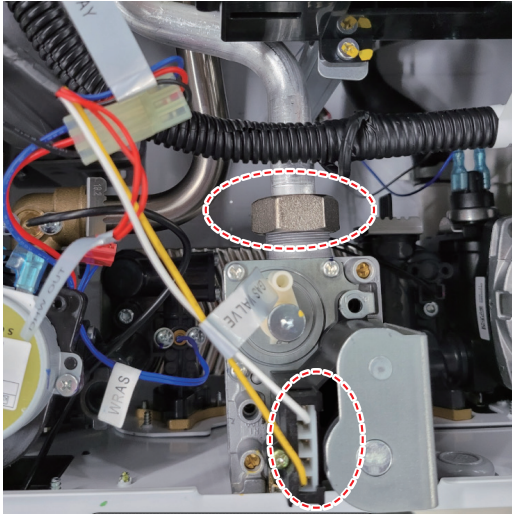

Figure 11

5. Remove the two screws located at the bottom of the unit that are attached to the gas valve.

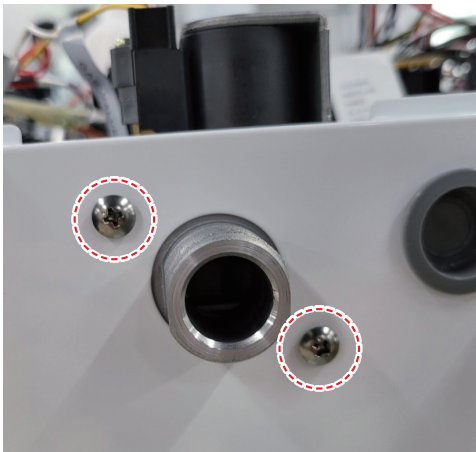

Figure 12

6. Replace the old gas valve with the new part.
7. Reconnect the gas valve assembly to the unit by using the two screws at the boiler.
8. Reattach the gas valve wiring connector.



WARNING

Failure to correctly assemble the components according to these instructions may result in a gas leak or explosion.

9. Check that all gas connections are tightly sealed to ensure that no gas leaks are present.
10. Turn on water supply, power supply, and gas supply to the unit.
11. Verify the gas pressures to the unit with the values provided in this Service Manual.

6.2.7 Condensate Trap

1. Turn off the gas supply to the unit.
2. Disconnect the unit from the power supply.
3. Turn off the water supply to the unit.
4. Remove the pin that secures the condensate drain cap and then remove the cap. Use a bucket to collect the condensate.

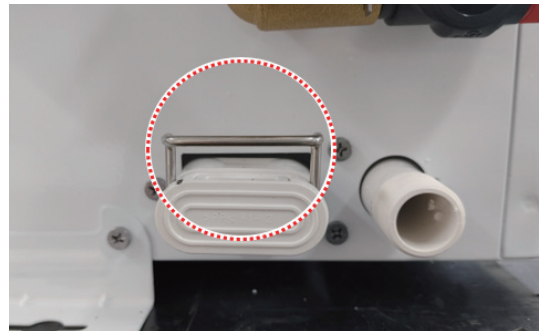

Figure 13

5. Detach the condensate piping from the unit.
6. Remove the two screws located at the bottom of the unit that are attached to the condensate trap.
7. Loosen the clip that secures the hose to the condensate trap, and then pull off the hose.
8. Remove the old condensation trap and replace it with the new part.
9. Reconnect the hose to the condensate trap.
10. Reattach the condensation trap to the unit and secure it using the five screws.
11. Replace the front panel to its original position.
12. Turn on the water supply, power supply, and gas supply to the unit.

Note

Ensure that the condensate drain trap is completely inserted into the condensate fitting to eliminate leaking. Use the pin to secure the cap to the fitting.

6.2.8 Circulation Pump

1. Turn off the gas supply to the unit.
2. Disconnect the unit from the power supply.
3. Turn off the water supply to the unit.
4. Loosen the central heating return pipe adaptor.

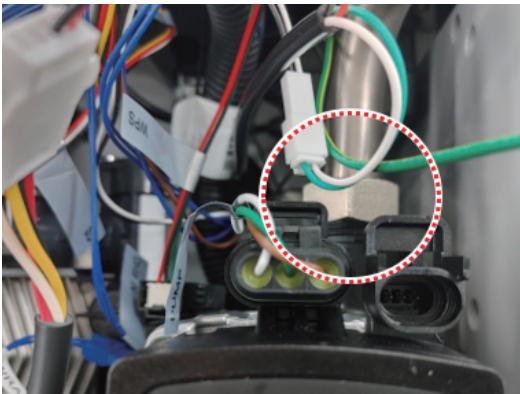

Figure 16

5. Remove the four screws and clip at the bottom of the cover.

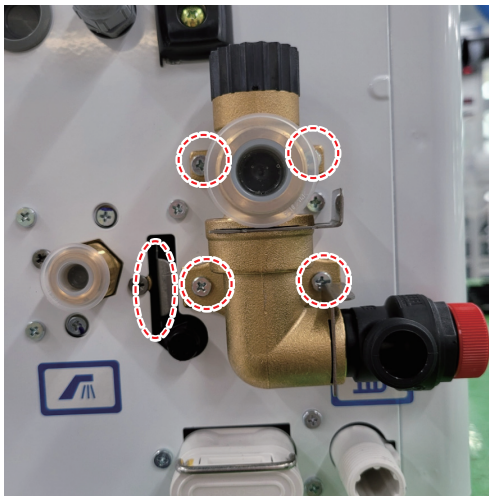

Figure 17

6. Reinstall the pump drain plug at the bottom of the unit.
7. Reconnect the wiring connector at the pump.
8. Install the Front panel back onto the unit by using the four screws.
9. Turn on water supply, power supply, and gas supply to the unit.
10. Open a hot water tap and ensure that there are no leaks at the pump connections.
11. Open the air vent on top of pump to release air within the system.

6.2.9 Water Pressure Sensor

1. Turn off the gas supply to the unit.
2. Turn off the 230V power supply to the unit.
3. Turn off the water supply to the unit. Drain all water from the appliance.
4. Detach the wire connector the connects the water pressure sensor.

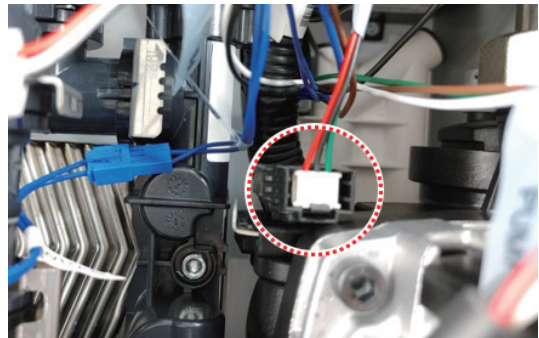

Figure 21

5. Remove the clip on the WPS valve.

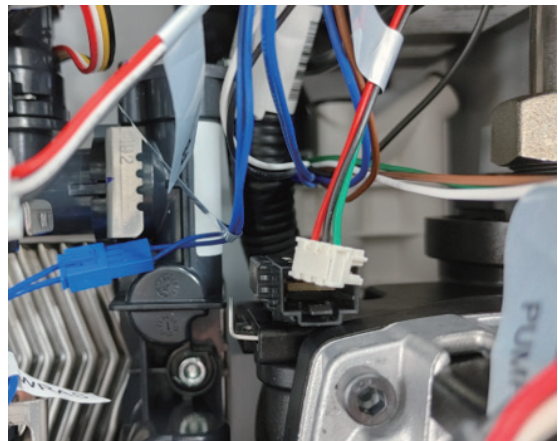

Figure 22

6. Replace with new water pressure sensor.
7. Connect the water pressure sensor wire housing.

Note Always use proper O-rings at the water pressure valve connection to ensure tight seals.

7. Components Diagram and Part List

7.1 Case Assembly

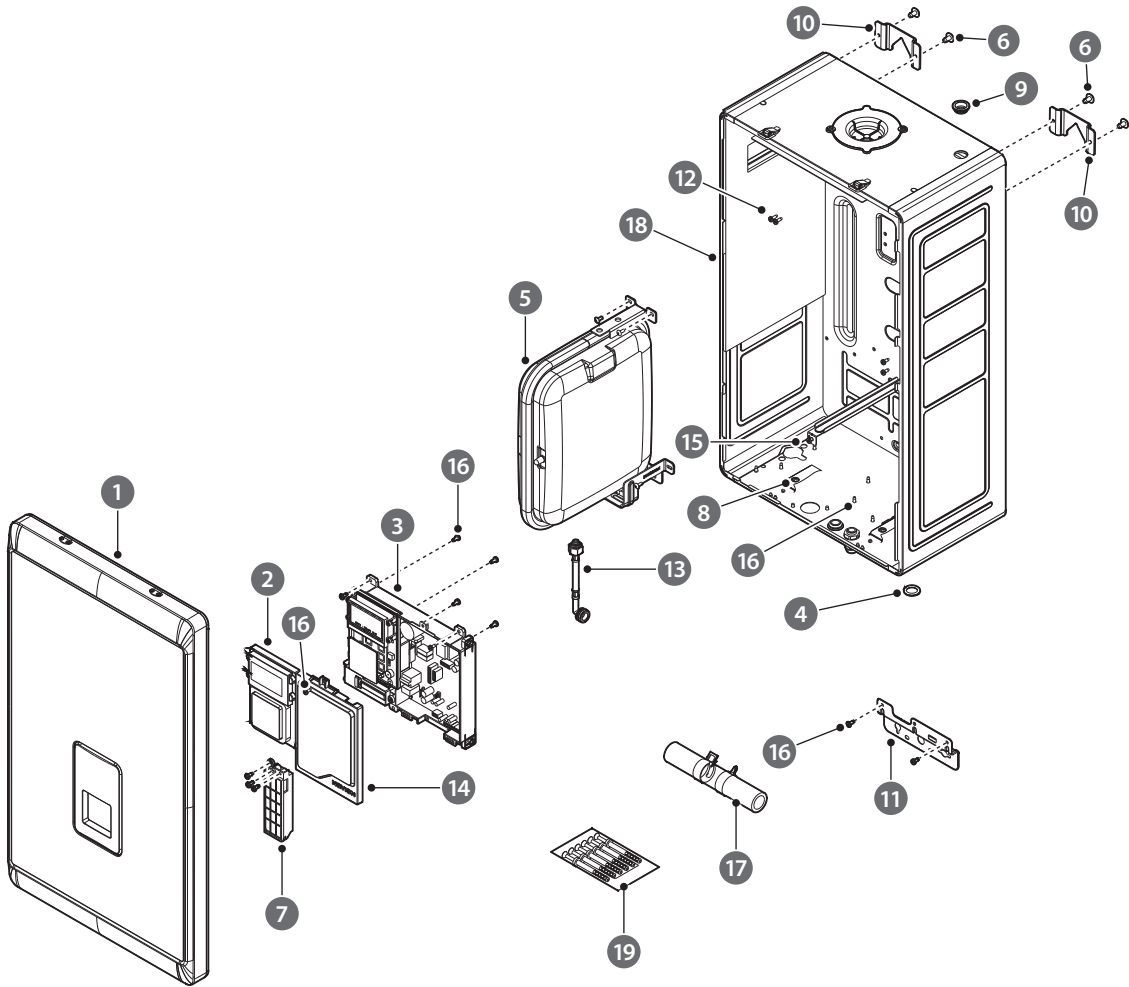

#	Description	Service Code	Part #	Quantity	Remark
1	Cover	30036929*	30036929A	1	
2	Front Panel	30029172*	30029172A	1	
3	PCB	30029600*	30029600A	1	
L	Wire Harness	30035491*	30035491A	1	Included in the Controller
4	O-Ring	20030919*	20030919A	1	
5	Expansion Vessel	30029043*	30029043A	1	
6	Screw (SCM435, M4×6)	20038859*	20038859A	1	
7	Terminal Block	30031006*	30031006A	1	
8	Hook Clamp	20030601*	20030601A	1	
9	Rubber Ring	20029318*	20029318A	2	
10	Bracket	20007609*	20007609A	1	
11	Bracket	20061907*	20061907A	1	
12	Screw (S18A, M4×12)	20041461*	20041461A	4	
13	Flexible Hose	20058211*	20058211A	1	
14	Cover	20057711*	20057711A	1	
15	O-Ring	20006953*	20006953A	1	
16	Screw (S18A, M4×10)	20038753*	20038753A	1	
17	Joint Hose	30018957*	30018957A	1	
18	Bracket	20058231*	20058231A	1	
19	Anchor	30002910*	30002910A	1	
-	Power Cable	30014421*	30014421A	1	

7.2 Combustion Assembly

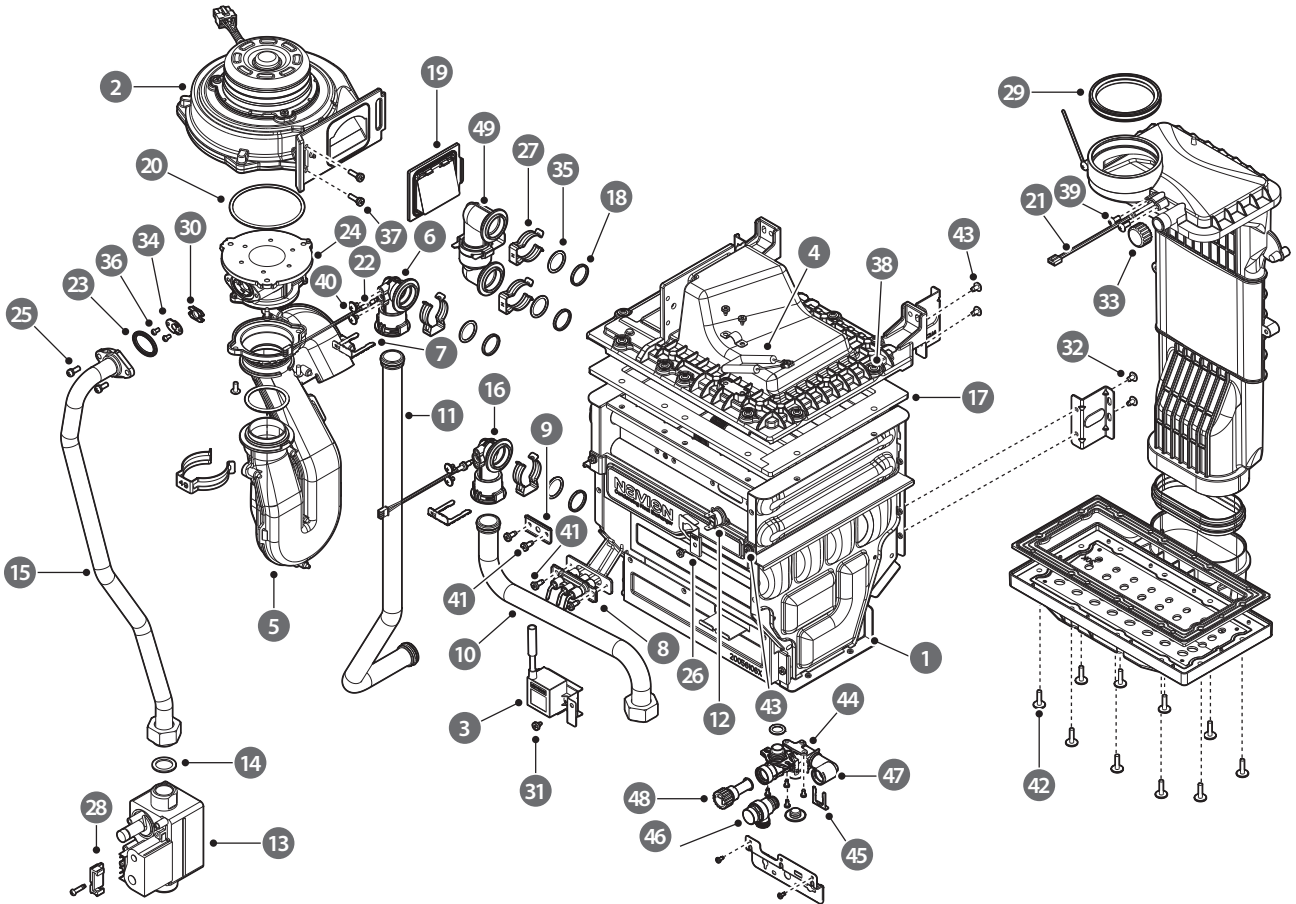

#	Description	Service Code	Part #	Quantity	Remark
1	Heat Exchanger	30036922*	30036922A	1	15K, 18K
		30030931*	30030931A	1	24K
		30030932*	30030932A	1	30K
2	Fan Assembly	30036715*	30036715A	1	15K
		30036718*	30036718A	1	18K
		30039362*	30039362A	1	24K
		30039363*	30039363A	1	30K
3	Ignition Transformer	30023139*	30023139A	1	
4	Thermal Fuse	30020776*	30020776A	1	
5	Pipe	30027843*	30027843A	1	18K
		30027844*	30027844A	1	15K, 24K
		30031280*	30031280A	1	30K
6	Heat Exchanger Outlet Adaptor	30027918*	30027918A	1	
-	Clip	20033662*	20033662A	1	
7	Clip	20007733*	20007733B	1	
8	Ignition/Flame Detector Electrode	30029150*	30029150A	1	
9	Flame Inspection Window	30030928*	30030928A	1	

#	Description	Service Code	Part #	Quantity	Remark
10	Heat Exchanger Inlet Pipe	30032975*	30032975A	1	15K, 18K
		30029062*	30029062A	1	24K
		30029034*	30029034A	1	30K
11	Heat Exchanger Outlet Pipe	30032962*	30032962A	1	15K, 18K
		30030280*	30030280A	1	24K
		30031620*	30031620A	1	30K
12	High Limit Stat	30002558*	30002558A	1	
13	Gas Valve	30019539*	30019539A	1	
14	Packing	20026127*	20026127A	1	
15	Gas Pipe	30032963*	30032963A	1	
		30031466*	30031466A	1	
		30039269*	30039269A	1	
16	Heat Exchanger Inlet Adaptor	20058120*	20058120A	1	
17	Burner Packing	30036925*	30036925A	1	15K, 18K
		30032519*	30032519A	1	24K
		30033266*	30033266A	1	30K
18	Backup Seal	20021730*	20021730B	2	
19	Fan Damper	30032692*	30032692A	1	
20	O-ring (Ø69.4×Ø3.1)	20007001*	20007001A	1	
21	Thermistor (single-stage)	30009478*	30009478A	1	
22	Thermistor (two-stage)	30008366*	30008366A	1	
23	Packing (Outer)	20054479*	20054479A	1	
24	Screw (S18A, M4×10)	20042708*	20042708A	3	
25	Screw (SCM435, M4×12,3)	20006390*	20006390A	2	
26	Overheat Temperature Switch Clip	20054283*	20054283A	1	
27	Clip	20038752*	20038752A	2	
28	Gas Valve Connector Cover	20033120*	20033120A	1	
29	Exhaust Duct Packing	20056624*	20056624A	1	
30	Packing (Inner)	20054478*	20054478A	1	
31	Screw (S18A, M4×6)	20038752*	20038752A	1	
32	Screw (S10A, M4×8)	20006536*	20006536A	4	
33	Vent Collar Cap	20029712*	20029712A	1	
34	Orifice	20058413*	20058413A	1	15K
		20058410*	20058410A	1	18K
		20060815*	20060815A	1	24K
		20058415*	20058415A	1	30K
35	O-ring (Ø18.8×Ø2.4)	20027347*	20027347A	2	
36	Screw (S10A, M3×6)	20018065*	20018065A	2	
37	Screw (S18A, M4×14)	20038760*	20038760A	2	

#	Description	Service Code	Part #	Quantity	Remark
38	Screw (STS410, M4x18)	20023655*	20023655A	10	
39	Screw (STS410, M4x10)	20019083*	20019083A	2	
40	Screw (S10A, M4x6)	20017962*	20017962A	2	
41	Screw (S18A, M4x10)	20038753*	20038753A	2	
42	Screw (STS410, M4x16)	20006455*	20006455A	10	
43	Screw (STS410, M4x12)	20041461*	20041461A	4	
44	Return Adaptor	30025803*	30025803A	1	
45	Clip	20007837*	20007837A	1	
46	Pressure Relief Valve	30002251*	30002251A	1	
47	Adaptor	20061682*	20061682A	1	
48	Cold Water Filter	30008171*	30008171A	1	
49	Heat Exchanger Outlet Adaptor	30028083*	30028083A	1	

7.3 Waterway Assembly

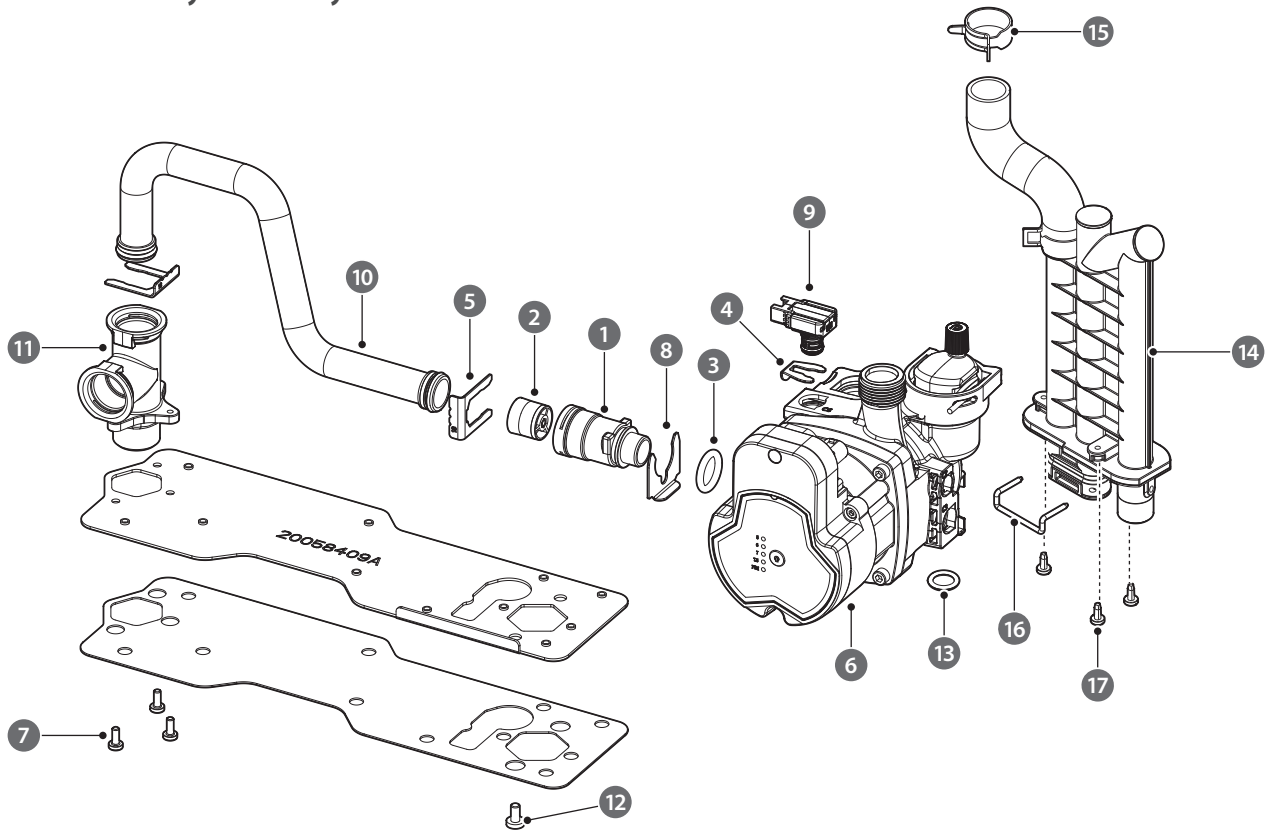

#	Description	Service Code	Part #	Quantity	Remark
1	Bypass Adaptor	20036044*	20036044A	1	
2	Check Valve	30017425*	30017425A	1	
3	O-ring (Ø17×Ø4)	20035694*	20035694A	1	
4	Clip	20048531*	20048531A	1	
5	Clip	20007837*	20007837A	1	
6	Circulation Pump (Shinwoo)	30032857*	30032857A	1	
7	Screw (STS430, M4x10)	20038758*	20038758A	1	
8	Clip	20035047*	20035047A	1	
9	Pressure Sensor	30024399*	30024399A	1	
10	Pipe	30030281*	30030281A	1	
11	Adaptor	20058416*	20058416A	1	
12	Screw	20009830*	20009830A	1	
13	O-ring	20030919*	20030919A	1	
14	Condensate Trap	30039665*	30039665A	1	
15	Clip	20007833*	20007833A	2	
16	Clip	20048219*	20048219A	1	
17	Screw	20038755*	20038755A	3	

8. Inspection and Maintenance Schedule

8.1 Annual Servicing

In order to maintain its safe and efficient operation, it is recommended that the boiler is serviced annually.



CAUTION

Servicing must be performed by a qualified service agency or gas supplier

Inspection

- Visual inspection for general signs of corrosion
- Checking and adjusting the gas/air ratio
- Checking flue gas
- Carrying out a water leak test in operation
- Carrying out a gas leak test in operation
- Checking hot water temperature and flow
- Checking noise
- Checking flue systems
- Checking the remote controller

Maintenance

- Draining the boiler and cleaning the inlet water filter
- Cleaning the Return Filter
- Cleaning the intake air filter
- Flushing the heat exchanger
- Replacement of parts

8.2 Maintenance Report

Inspection Items	Record	Date:	Date:
Draining the Boiler and Cleaning the Inlet Water Filter	YES / NO		
Cleaning the Return Filter	YES / NO		
Checking the Intake Air Filter	YES / NO		
Flushing the Heat Exchanger	YES / NO		
Replacement of Parts			

8.3 Maintenance Schedules

Owner maintenance	
Daily	<ul style="list-style-type: none"> • Check boiler area • Check pressure / temperature gauge
Monthly	<ul style="list-style-type: none"> • Check flue piping • Check air piping (if installed) • Check air and flue termination screens • Check relief valve • Check condensate drain • Check air ducts
Periodically	<ul style="list-style-type: none"> • Test low water cut-off (if used) • Reset button (low water cut-off)
Every 6 months	<ul style="list-style-type: none"> • Check boiler piping (gas and water) for leaks Operate relief valve
End of heating season	<ul style="list-style-type: none"> • Shut boiler down (unless boiler used for domestic hot water)

8.4 Inspection Report

Inspection Items	Record	Date:	Date:
Visual Inspection for General Signs of Corrosion	YES / NO		
Checking and Adjusting the Gas/Air Ratio	YES / NO		
Checking Flue Gas	YES / NO		
Carrying Out a Water Leak Test in Operation	YES / NO		
Carrying Out a Gas Leak Test in Operation	YES / NO		
Checking Hot Water Temperature and Flow	YES / NO		
Checking Noise	YES / NO		
Checking Flue Systems	YES / NO		
Checking the front panel.	YES / NO		

8.5 Routine Servicing

Navien advises on an interim service inspection with a flue gas analyser. A full strip down service is recommended at regular intervals or where analyser readings are not within correct safety standards.

8.5.1 Interim Service

For reasons of safety and economy, it is recommended that the boiler is serviced annually. Servicing must be performed by a competent person in accordance with BS 7967. After servicing, complete the relevant Service Interval Record section of the Benchmark Checklist located on the inside back page of this document.

Service technician (See the following instructions)	
Annual Start-up	<p>General:</p> <ul style="list-style-type: none"> • Address reported problems • Inspect interior; clean and vacuum if necessary • Clean condensate trap and fill with fresh water • Check for leaks (water, gas, flue, condensate) • Verify flue and air lines are in good condition and sealed tight • Check system piping • Check control settings • Check ignition and flame rod (clean and reposition) • Check wiring and connections • Flame inspection (stable, uniform) • Flame signal • Remove and clean return adaptor filter • Servicing of the in-line magnetite filter • Check system inhibitor concentration and appropriate action taken, in accordance with BS 7593



WARNING

- Follow the service and maintenance procedures given throughout this manual and in component literature shipped with the boiler. Failure to perform the service and maintenance could result in damage to the boiler or system.
- Failure to follow the directions in this manual and component literature could result in severe personal injury or substantial property damage.
- The boiler should be inspected annually only by a qualified service technician. In addition, the maintenance and care of the boiler must be performed to assure maximum boiler efficiency and reliability. Failure to service and maintain the boiler and system could result in equipment failure.
- Electrical shock hazard – Turn off power to the boiler before any service operation on the boiler except as noted otherwise in this instruction manual. Failure to turn off electrical power could result in electrical shock, causing severe personal injury.

Addressing the Reported Problems

Inspect any problems reported by the owner and correct before proceeding.

Inspecting the Installation Area

1. Verify that boiler area is free of any combustible materials, petrol and other flammable vapours and liquids.
2. Verify that air intake area is free of any of the contaminants listed in Installation & Operation Manual. If any of these are present in the boiler intake air vicinity, they must be removed. If they cannot be removed, reinstall the air and flue lines per the Installation & Operation Manual.

Inspecting the Boiler Interior

1. Remove the front cover and inspect the interior of the boiler.
2. Vacuum any sediment from inside the boiler and components. Remove any obstructions.

Cleaning the Condensate Trap

1. Inspect the condensate drain line, condensate fittings, and condensate trap.
2. Remove any sediment from the trap.
3. Fill with fresh water until the water begins to pour out of the drain.

Checking all Piping for Leaks

Eliminate all system or boiler leaks. Continual fresh water will reduce boiler life. Minerals can build up in sections, reducing heat transfer, overheating heat exchanger, and causing heat exchanger failure. Leaking water may also cause severe property damage.

1. Inspect all water and gas piping and verify to be leak free.
2. Look for signs of leaking lines and correct any problems found.

Checking the Flue System and Air Piping

1. Visually inspect the entire flue system for blockage, deterioration or leakage. Repair any joints that show signs of leakage. Verify that air inlet pipe is connected and properly sealed (if installed).
2. Verify that boiler flue discharge and air intake are clean and free of obstructions.



WARNING

Failure to inspect for the above conditions and have them repaired can result in severe personal injury.

Checking the Water System

1. Verify all system components are correctly installed and operational.
2. Check the cold fill pressure for the system. Verify it is correct (must be a minimum of 0.8 bar).
3. Watch the system pressure as the boiler heats up (during testing) to ensure pressure does not rise too high.

- Note**
- If the system contains glycol, test for proper concentration as recommended by manufacturer.
 - Excessive pressure rise indicates expansion tank sizing or performance problem.

4. Inspect automatic air vents and air separators. Remove air vent caps and briefly press push valve to flush the system.
5. Replace caps. Make sure air vents do not leak. Replace any leaking vents.

Inspecting the Ignition and Flame Detector Electrodes

1. Remove the ignition and flame detector electrodes from the boiler heat exchanger.
2. Remove any deposits accumulated on the ignition/flame detector electrode. If the electrodes cannot be cleaned satisfactorily, replace with new ones.
3. Replace ignition/flame detector electrode, making sure gasket is in good condition and correctly positioned.

Checking the Ignition Ground Wiring

1. Check that the ground wire is in good condition and securely attached to the boiler casing.
2. Check ground continuity of wiring using continuity meter.
3. Replace ground wires if ground continuity is not satisfactory.

Checking all Boiler Wiring

Inspect all boiler wiring, making sure wires are in good condition and securely attached.

Checking the Control Settings

Check settings of external limit controls (if any) and adjust if necessary.

Performing Start-up and Checks

1. Start boiler and make sure that the boiler is operating properly.
2. Verify cold fill pressure is correct and that operating pressure does not go too high.

Check the Burner Flame

1. Inspect flame through observation window.
2. If the flame is unsatisfactory at either high fire or low fire, check for obstructions in the flue.

Checking the CO₂

1. Check the CO₂ readings at full load and low load.
2. Check the CO readings and combustion performance (CO/CO₂ ratio).
3. Check the CO readings and combustion performance. For more information, refer to the 15th step in "4.3 Gas Conversion" on page 20. The combustion reading (CO/CO₂ ratio) must be less than 0.004.
4. If the combustion reading (CO/CO₂ ratio) is greater than this, and the integrity of the complete flue system and combustion circuit seals should be verified, and the inlet gas pressure and gas rate are satisfactory either:
 - Perform the full service. For more information, refer to "8.5.2 Full Service" on page 103.
 - Set the Gas Valve. For more information, refer to "4.2 Measuring the Inlet Gas Pressure" on page 19.

Review with the Owner

1. Review the User's Information Manual with the owner.
2. Emphasize the need to perform the maintenance schedule.
3. Remind the owner of the need to call a licensed contractor should the boiler or system exhibit any unusual behaviour.
4. Remind the owner to follow the proper shutdown procedure and to schedule an annual start-up at the beginning of the next heating season.
5. After servicing, complete the relevant Service Interval Record section of the Benchmark Checklist located on the inside back page of this document.

8.5.2 Full Service

For reasons of safety and economy, it is recommended that the boiler is serviced annually. Servicing must be performed by a competent person in accordance with BS 7967-4. After servicing, complete the relevant Service Interval Record section of the Benchmark Checklist located on the inside back page of this document.

Note Where a full service is required, refer to "8.5.1 Interim Service" on page 101.

1. Press the Power button (⏻) on the front panel to turn off the boiler.

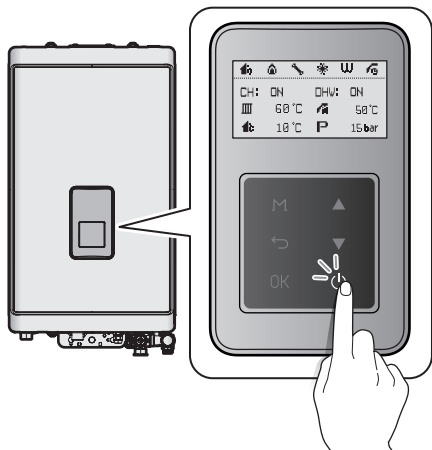

2. Disconnect the power supply to the boiler.
3. Turn off both gas and water supply to the boiler.

Note Wait at least 30 minutes for the heat exchanger to cool down.

4. Unfasten the 2 latches (at the top) and remove 2 screws (at the bottom) to remove the front cover to gain access to the internal components.

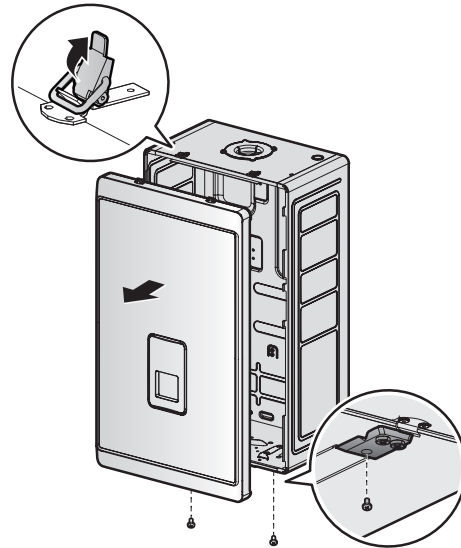

5. Once the front cover is removed, place it in a safe location to prevent accidental damage.
6. Loosen the three screws holding the front panel and remove the front panel.

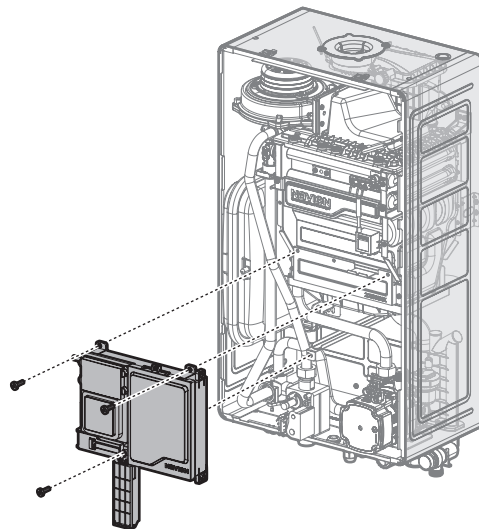

Note When removing the front panel, label all wires and make sure all wires are disconnected.

- Use a Phillips screwdriver to remove the two screws where gas inlet pipe is attached to the fan motor assembly. Loosen the hex nut located above the gas valve and remove the gas pipe.

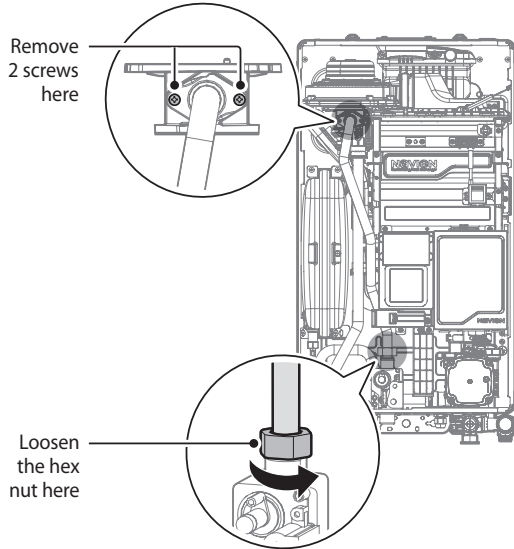

- Remove the screw connecting the fan motor assembly and the mixing chamber, and then remove the fan motor assembly.

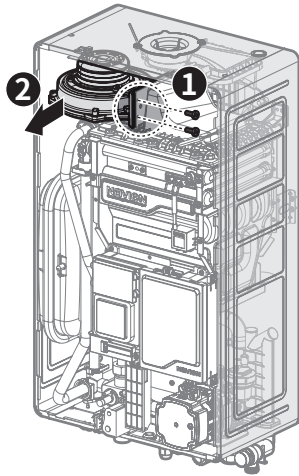

- Remove the four bolts securing the chamber brackets.

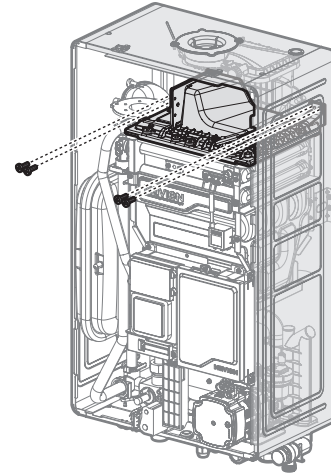

- Remove the rubber packing at the top of the cover and put a Phillips screwdriver into the hole, and then loosen the middle bolt located at the back of the burner.

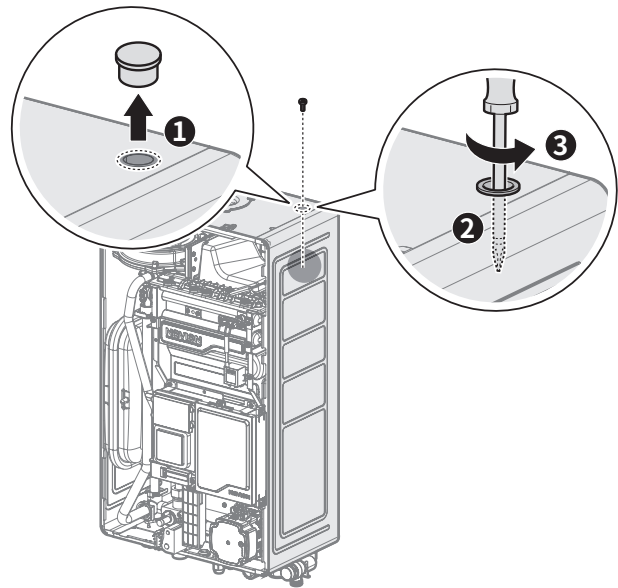

- Remove the ten bolts connecting the mixing chamber and the heat exchanger, and then remove the mixing chamber, burner and the chamber bracket.

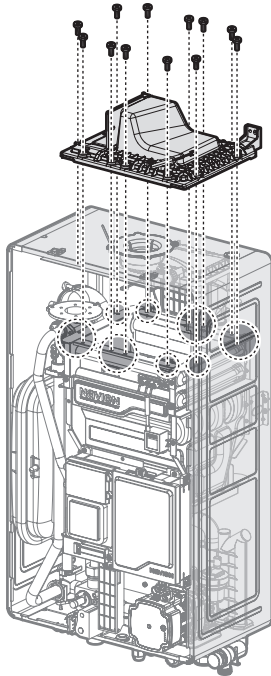

- Use the brush to dislodge the debris and pour water down the channels to flush out the debris.

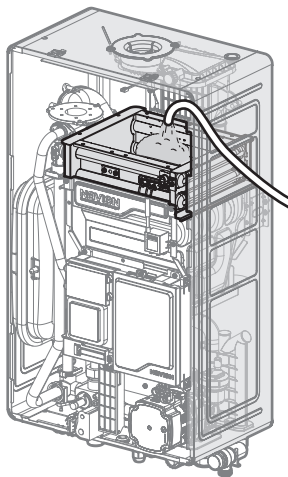

Note

- It is important to keep electric parts of the boiler safe from water.
- Navien recommends to use a hose.
- If the water pressure of the hose is too high, water may splash to other electric parts of the boiler. Keep the water pressure of the hose as low as it can.
- If the boiler is installed in high area and you cannot see the inside of the heat exchanger, use a solid support and be careful not to fall.

- As cleaning the heat exchanger is finished, reassemble the parts.
- Check the CO₂. For more information on measuring the CO₂, refer to "Checking the CO₂" on page 102.

Note

This boiler requires very little maintenance, however a qualified technician should inspect the boiler at the beginning of every heating season and/or when there is a problem.

8.5.3 CO and Combustion Checks

IMPORTANT PRELIMINARY INFORMATION ON CHECKS

Note

The air gas ratio valve is factory set and must not be adjusted during commissioning unless this action is recommended following contact with the manufacturer.

- If any such adjustment is recommended and further checking of the boiler is required the installer/service engineer must be competent to carry out this work and to use the flue gas analyser accordingly.
- If the boiler requires conversion to operate with a different gas family (e.g. conversion from natural gas to LPG) separate guidance will be provided by the boiler manufacturer.
- The boiler manufacturer's installation instructions should have been followed, gas type verified and gas supply pressure/rate checked as required prior to commissioning.
- As part of the installation process, **especially where a flue has been fitted by persons other than the boiler installer**, visually check the integrity of the whole flue system to confirm that all components are correctly assembled, fixed and supported. Check that manufacturer's max. flue lengths have not been exceeded and all guidance has been followed (e.g. Gas Safe Technical Bulletin TB008 where chimney/flues are in voids).
- The Flue Gas Analyser should be of the correct type, as specified by BS 7967. Prior to its use, the flue gas analyser should have been maintained and calibrated as specified by the manufacturer. The installer must have the relevant competence for use of the analyser.
- Check and zero the analyser in fresh air as per analyser manufacturer's instructions.
 - CO:** carbon monoxide, **CO₂:** carbon dioxide, **O₂:** oxygen, **ppm:** parts per million
 - Combustion ratio:** The CO reading measured in ppm divided by the CO₂ reading first converted to ppm
 - GU(I&U)R:** Gas Safety (Installation and Use) Regulations

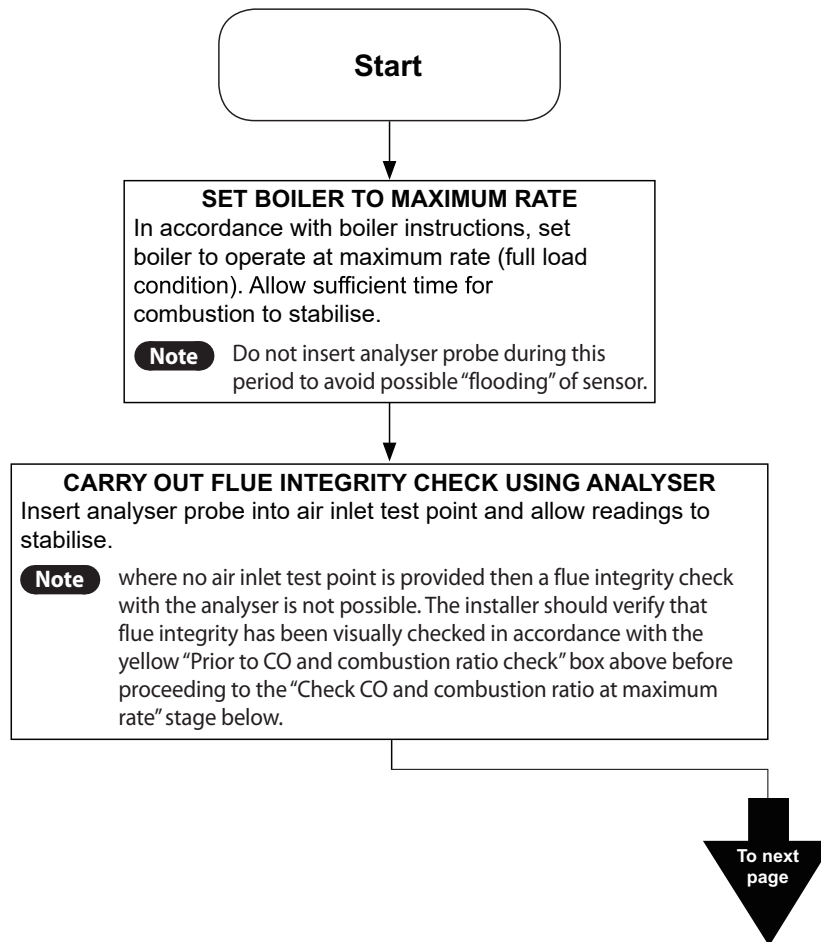

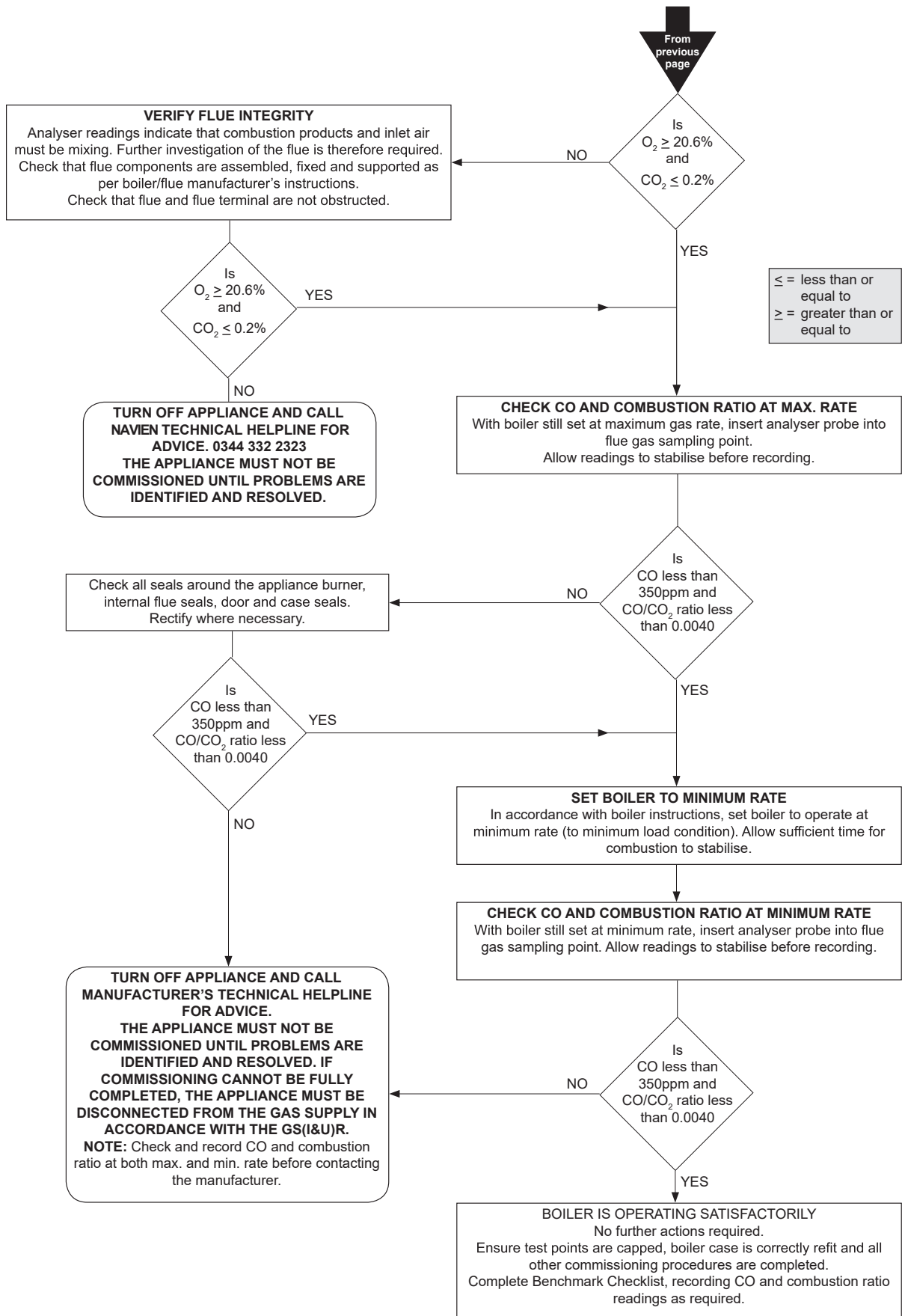

Memo

Memo

Memo

Memo
