

Service Manual

Getting Service

If your water heater requires service, you have several options for getting service:

- Contact an official Technical Assistance Service (TAS) at 0844 332 2323 or go to the website (www.navien.co.uk).
For warranty service, always contact an official Technical Assistance Service (TAS) first.
- Contact the technician or professional who installed your water heater.
- Contact a Gas Safe Registered engineer.

When you contact an official Technical Assistance Service (TAS), please have the following information at hand:

- Model number
- Serial number
- Date purchased
- Installation location and type
- Error code, if any appears on the front panel display.

Version: 1.00 (Feb. 19, 2018)



navien Condensing Water Heater

Service Manual

Model _____

NPE-24AWE

NPE-24SWE

NPE-32AWE

NPE-32SWE

- These appliances are for use with natural gas or LPG. (An LPG conversion kit is included with the water heater.)
 - Type: B23-B33-B53-C13-C33-C43-C53-C63-C83
- Keep this manual near this water heater for future reference whenever maintenance or service is required.

WARNING

If the information in these instructions is not followed exactly, a fire or explosion may result, causing property damage or personal injury.

- **Do not store or use petrol or other flammable vapours and liquids in the vicinity of this or any other appliance.**
- **WHAT TO DO IF YOU SMELL GAS**
 - Do not try to light any appliances.
 - Do not touch any electrical switch; do not use any phone in your building.
 - Immediately call the National Gas Emergency Helpline on (Freephone) 0800 111999 or your gas supplier from a neighbour's phone. Follow the instructions received.
- **Installation and service must be performed by a Gas Safe registered installer, service agency or the gas supplier.**

Contents

| | | | |
|---|-----------|---|------------|
| 1. Safety Information | 7 | | |
| 1.1 Safety Definitions | 7 | | |
| 1.2 Safety Symbols | 7 | | |
| 1.3 Symbols Used in the Instructions | 7 | | |
| 1.4 Safety Precautions | 7 | | |
| 2. Product Information | 12 | | |
| 2.1 Product Information | 12 | | |
| 2.2 Layout and Key Components | 13 | | |
| 3. Technical Data | 15 | | |
| 3.1 General Specifications | 15 | | |
| 3.2 Dimensions | 16 | | |
| 4. System Details | 18 | | |
| 4.1 Schematic and Flow Diagram | 18 | | |
| 4.2 Operation Flow Chart | 20 | | |
| 4.3 Setting the DIP Switches | 21 | | |
| 4.4 Measuring the Inlet Gas Pressure | 23 | | |
| 4.5 Selecting a Recirculation Mode ("AWE" model only) | 26 | | |
| 4.6 Gas Conversion | 28 | | |
| 4.7 The Front Panel | 32 | | |
| 4.8 Wiring Diagram | 51 | | |
| 4.9 Ladder Diagram | 52 | | |
| 4.10 Electrical Diagnostic Points | 54 | | |
| 4.11 Key Components Description | 56 | | |
| 4.11.1 PCB | 56 | | |
| 4.11.2 High Limit Switch | 57 | | |
| 4.11.3 Anti Frozen Switch | 58 | | |
| 4.11.4 Anti Frozen Heater | 59 | | |
| 4.11.5 Thermistor | 60 | | |
| 4.11.6 Fan Motor | 61 | | |
| 4.11.7 Flame Rod Assembly | 62 | | |
| 4.11.8 Ignition Transformer | 63 | | |
| 4.11.9 APS | 64 | | |
| 4.11.10 Main Gas Valve | 65 | | |
| 4.11.11 Burner | 66 | | |
| 4.11.12 Water Adjustment Valve | 67 | | |
| 4.11.13 Flow Sensor | 68 | | |
| 4.11.14 Primary Heat Exchanger | 69 | | |
| 4.11.15 Secondary Heat Exchanger | 70 | | |
| 4.11.16 Buffer Tank ("A" models only) | 71 | | |
| 4.11.17 Circulation Pump ("A" models only) | 72 | | |
| 5. Troubleshooting | 73 | | |
| 5.1 Error Code List | 73 | | |
| 5.1.1 003Error | 76 | 5.1.11 407Error | 97 |
| 5.1.2 004Error | 82 | 5.1.12 421Error | 98 |
| 5.1.3 012Error | 83 | 5.1.13 432Error | 99 |
| 5.1.4 016Error | 86 | 5.1.14 434Error | 100 |
| 5.1.5 030Error | 89 | 5.1.15 438Error ("A" models only) | 103 |
| 5.1.6 046Error | 91 | 5.1.16 439Error | 105 |
| 5.1.7 047Error | 91 | 5.1.17 441Error | 108 |
| 5.1.8 060Error | 92 | 5.1.18 445Error | 108 |
| 5.1.9 109Error | 94 | 5.1.19 515Error | 111 |
| 5.1.10 110Error | 96 | 5.1.20 517Error | 112 |
| | | 5.1.21 593Error | 112 |
| | | 5.1.22 594Error | 113 |
| | | 5.1.23 615Error | 113 |
| | | 5.1.24 736Error | 114 |
| | | 5.1.25 782Error | 114 |
| | | 5.1.26 740Error | 115 |
| | | 5.1.27 760Error | 115 |
| | | 5.1.28 785Error | 115 |
| | | 5.2 Troubleshooting guide by symptom | 116 |
| | | 6. Replacement of Parts | 119 |
| | | 6.1 Replacement Procedure | 119 |
| | | 6.2 Components Replacement Instructions | 119 |
| | | 7. Components Diagram and Part List | 130 |
| | | 7.1 Case Assembly | 130 |
| | | 7.2 Burner Assembly (NPE-24AWE/32AWE) | 131 |
| | | 7.3 Burner Assembly (NPE-24SWE/32SWE) | 132 |
| | | 7.4 Waterway Assembly (NPE-24AWE/32AWE) | 133 |
| | | 7.5 Waterway Assembly (NPE-24SWE/32SWE) | 134 |
| | | 7.6 Fan(Gas) Assembly | 135 |
| | | 8. Inspection and Maintenance Schedule | 136 |
| | | 8.1 Maintenance | 136 |
| | | 8.2 Annual Servicing | 139 |
| | | 8.3 Inspection Report | 140 |
| | | 8.4 Maintenance Report | 140 |
| | | 9. Common Vent and Outdoor vent Cover Installing | 141 |
| | | 9.1 Installing the Outdoor vent Cover | 141 |
| | | 9.2 Installing Procedure | 142 |
| | | 9.3 Choosing an Installation Location | 143 |
| | | 9.4 Mounting Water Heater | 144 |
| | | 9.5 Ventilation Flow | 145 |
| | | 9.6 Common Venting | 146 |
| | | 10. Configuring the Water Heater | 148 |
| | | 10.1 Configuring the NPE-24A/32A Water Heater | 148 |
| | | 10.2 Maintenance | 153 |
| | | 10.3 Appendix | 153 |

Guarantee

Guarantee Conditions

Navien's commercial guarantee covers the correct functioning of the products manufactured by Navien, in accordance with the following conditions and time periods:

1. This commercial guarantee is valid for the following periods, as from the start-up date:
 - 2 years for electric and hydraulic elements, pumps, valves, etc.
 - 5 years for heat exchangers.
 - 5 years for domestic hot water tanks.
 - During the 2-year period following the start-up date, Navien will carry out any repairs of original flaws or defects totally free of charge.
 - After these 2 years have elapsed and until the end of the guarantee period, labour costs and call-out charges will be payable by the user.
2. The annual overhaul is not included in the terms of this guarantee.
3. The start-up and annual overhaul are to be carried out by personnel authorised by Navien.
4. The commercial guarantee will be null and void in the following cases:
 - If the annual overhaul by personnel authorised by Navien has not been carried out.
 - If the water heater has not been installed in accordance with the applicable laws and regulations for this type of appliance.
 - If the water heater has not been started up immediately after its installation, by personnel authorised by Navien.

Failures due to misuses or incorrect installation, use of non-suitable power or fuel, supply with water with physical or chemical properties causing incrustation or corrosion, incorrect handling of the appliance and, in general, for any reason beyond Navien's control, are excluded from this guarantee.

This guarantee does not affect the consumer's rights as stipulated by law.

Note: Start-up is included in the price of the water heater. The call-out charge is not included.

Suitable Use

The NPE-AWE/NPE-SWE model water heaters are designed with all the necessary safety systems. Unsuitable use of the appliance for a purpose it was not designed for entails risk of damage to the water heater or property, and even of injury to the user and other persons.

The NPE-AWE/NPE-SWE model water heaters are designed to generate heat for domestic hot water and to be connected to central heating systems. Any use other than the above will be considered unsuitable use of the water heater. In such cases the manufacturer/supplier shall not be liable for any damage caused, and the user will be liable for the damage. Correct use of the water heater includes reading the user and installation instructions and all applicable documents, and complying with the maintenance and inspection conditions.

Everyday Care

Clean the outside of the water heater with a damp cloth with a little detergent. Do not use abrasive products to clean the water heater.

Waste Recycling and Disposal

Observe the applicable national regulations and standards concerning waste disposal.

The water heater

Neither the wall-mounted water heater or its accessories are to be disposed of with the domestic waste. Ensure the appliance and its accessories, where applicable, are suitably disposed of.

Packaging

The transport packaging will be disposed of by the specialist technician who made the installation.

Abbreviations and Definitions

| Abbreviation | Definition |
|--------------|--|
| NPE | General name of NPE-24AWE, NPE-24SWE, NPE-32AWE, and NPE-32SWE |
| NG | Natural Gas |
| LP | Propane Gas |
| AP | Air Pressure |
| APS | Air Pressure Sensor |
| DHW | Domestic Hot Water |
| FM | Fan Motor |
| GARC | Gas Air Ratio Control |
| GPM | Gallons Per Minute |
| GV | Gas Valve |
| MGV | Main Gas Valve |
| RPM | Revolutions Per Minute |
| WAV | Water Adjustment Valve |
| PCB | Printed Circuit Board |
| EMI | Electromagnetic Interface |
| HTL | High Temperature Limiter |

1. Safety Information

1.1 Safety Definitions

All Safety messages indicate the risk of potential hazards. Follow the instructions precisely to avoid the risk of injury.



This is the safety alert symbol. It is used to alert you of potential personal injury hazards. Observe all of the safety messages that follow this symbol to avoid possible injury or death.

1.2 Safety Symbols



DANGER

Indicates an imminently hazardous situation which, if not avoided, could result in severe injury or death.



WARNING

Indicates a potentially hazardous situation which, if not avoided, could result in injury or death.



CAUTION

Indicates a potentially hazardous situation which, if not avoided, may result in minor or moderate injury.

1.3 Symbols Used in the Instructions

The following symbols are used throughout the instructions to bring attention to important information concerning the appliance.



IMPORTANT

Warns of a risk of damage and environmental pollution



NOTE

Indicates additional information that is important but not related to personal injury or property damage.

1.4 Safety Precautions



DANGER

FLAMMABLE MATERIALS

Keep the area around the water heater clear and free from flammable materials.

- DO NOT place flammable liquids such as oils or gasoline, etc. near the water heater.
- DO NOT place combustibles such as newspapers and laundry etc. near the water heater or the venting system.
- DO NOT place or use hair spray, spray paint or any other type of spray can near the water heater or the venting system (including the vent termination).
- DO NOT place anything in or around the vent terminations that could obstruct the air flow in and out of the water heater such as a clothes line.

 **DANGER**



FLAMMABLE VAPORS

Vapors from flammable liquids will explode and catch fire causing death or severe burns.

Do not use or store flammable products such as gasoline, solvents or adhesives in the same room or area near the water heater.

- **Keep flammable products:** far away from the water heater in approved containers, tightly closed, and out of children's reach.
- **Water heater has a main burner flame:** which can come on at any time, and may ignite flammable vapors.
- **Vapors:** cannot be seen, are heavier than air, go a long way on the floor and can be carried from other rooms to the main burner flame by air currents.

 **DANGER**

COMPROMISED VENTING SYSTEM

- Failure to follow the Venting Section of the installation manual may result in unsafe operation of this water heater. To avoid the risk of fire, explosion or asphyxiation from carbon monoxide, never operate the water heater unless it is properly vented to the outside and has an adequate air supply for proper operation.
- Be sure to inspect the vent termination and the air intake pipe annually to ensure safe operation of the water heater.
- Immediately turn off and do not use the water heater if any of the vent pipes, vent elbows and/or the water heater are:
 - damaged in any way;
 - separated at a joint,
 - cracked or show evidence of corrosion, rusting or melting.

 **DANGER**

HOT WATER TEMPERATURE SETTING

- Water temperatures at or above 52 °C (125 °F) can cause severe burns instantly or death from scalds.
- Households with small children, disabled, or elderly persons may require 49 °C (120 °F) or lower temperature setting to prevent contact with "HOT" water.

 **DANGER**

WHAT TO DO IF YOU SMELL GAS

If you do not follow these instructions exactly, a fire or explosion may result causing property damage, personal injury or loss of life.

DO NOT OPERATE THE WATER HEATER.

DO NOT OPERATE ANY FAUCETS.

Smell all around the appliance area for gas. Be sure to smell next to the floor because some gas is heavier than air and will settle on the floor.

- Do not smoke.
- Extinguish any open flames and sparks.
- Do not operate light switches or electrical equipment switches.
- Do not use any phone in your building.
- Open the windows and doors.
- Close the gas shutoff valve.
- Keep people away from the danger zone.
- Observe the safety regulations of your local gas supplier, found on the gas meter.
- Immediately call your gas supplier from the outside of the building. Follow the gas supplier's instructions.
- If you cannot reach your gas supplier, call the fire department.
- Notify your plumbing/heating contractor from the outside of the building.

! DANGER



HOT WATER TEMPERATURE SETTING

- Water temperatures at or above 52 °C (125 °F) can cause severe burns instantly or death from scalds.
- Households with small children, disabled, or elderly persons may require 49 °C (120 °F) or lower temperature setting to prevent contact with "HOT" water.
- To prevent scalding, check water temperature after servicing.
- If the proposed water heater outlet temperature is at or above 52 °C (125 °F), a thermostatically controlled mixing valve or temperature limiting valve should be considered to reduce the risk of scalding. Contact a licensed plumber or the local plumbing authority for further information.
- This Navien Water Heater is factory set at 49 °C (120 °F) for your safety and comfort. Increasing the set temperature increases the risk of accidental scalding. Consult the chart below before you decide to adjust the set temperature.

| Water Temperature | Time in which a young child can suffer a full thickness (3rd degree) burn |
|-------------------|---|
| 70 °C (160 °F) | Less than 1 second |
| 60 °C (140 °F) | 1 second |
| 55 °C (130 °F) | 10 second |
| 49 °C (120 °F) | 10 minutes |
| 37 °C (110 °F) | very low scald risk |

! DANGER

IMPORTANT SAFETY PRECAUTIONS

- Read and understand this safety information before operating or servicing this Navien Water Heater.
- Confirm the location of the gas shut-off valve. Close the manual shut-off valve if the Navien Water Heater ever becomes subjected to overheating, fire, flood, physical damage or any other such damaging condition during servicing.
- DO NOT turn on the water heater unless water and gas supplies are fully opened.
- DO NOT turn on the water heater if the cold water supply shut-off valve is closed.
- Make certain power to the water heater is "OFF" before removing the front cover for any reason.
- Label all wires prior to disconnection when servicing controls. Wiring errors can cause improper and dangerous operation. Verify proper operation after servicing.
- Improper adjustment, alteration, service or maintenance can cause property damage, personal injury, or death.
- To prevent scalding, always check the temperature of the hot water after servicing.
- DO NOT attempt to change the water temperature while someone is using the water heater.
- DO NOT use parts other than those specified for this equipment.
- DO NOT operate the water heater if you feel something is wrong with the unit.
- DO NOT allow children to operate or otherwise handle the unit.

! DANGER

INSTALLATION REQUIREMENTS

Installation conditions may affect how the water heater is serviced. Read all related information in the "Installation Manual".

 **WARNING**

GAS TYPE and AC VOLTAGE

This water heater is configured for Natural Gas from the factory. If conversion to Propane Gas is required, the conversion kit supplied with the water heater must be used.

- Be sure to use 120 VAC, 50 Hz, minimum 2 A current. Using abnormally high or low AC voltage may cause abnormal operation, and may reduce the life expectancy of this product.

If the unit does not match requirements, do not service, please contact Navien immediately.

 **WARNING**

GAS CONVERSION

The conversion kit shall be installed by a qualified service agency in accordance with Navien's instructions and all applicable codes and requirements of the authority having jurisdiction. The information in these instructions must be followed to minimize the risk of fire or explosion or to prevent property damage, personal injury or death. The qualified service agency is responsible for the proper installation of this kit. The installation is not proper and complete until the operation of the converted appliance is checked as specified in the manufacturer's instructions supplied with the kit.

 **WARNING**

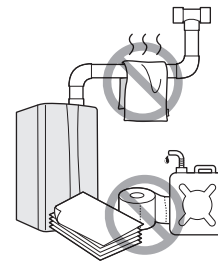

- **Shut off the gas supply if the water heater is damaged.**
Have your installer or plumber show you the location of the gas shut off valve and demonstrate how to close the valve. If the water heater is damaged as a result of overheating, fire, flood, or any other reason, close the manual shut off valve and do not operate the water heater again until it has been inspected by a qualified technician.
- **Do not store or use gasoline or other flammable liquids near this water heater.**
Doing so may result in fire or explosion.
- **Do not place combustibles, such as newspapers or laundry, near the water heater or venting system.**
Doing so may result in a fire.
- **Do not place or use hair sprays, spray paints, or any other compressed gases near the water heater or venting system, including the vent termination.**
Doing so may result in fire or explosion.
- **Do not operate the water heater with the front cover opened.**
Doing so may result in fire or carbon monoxide (CO) poisoning, which may result in property damage, personal injury, or death.
- **Do not operate this water heater without proper venting.**
Doing so may result in fire or carbon monoxide (CO) poisoning, which may result in property damage, personal injury, or death. Inspect the vent termination and air intake supply annually to ensure proper operation of the water heater. Turn off and discontinue use of the water heater if any of the vent pipes, vent elbows, or intake pipes are damaged in any way, separated at a joint, or show evidence of corrosion, rusting, or melting.
- **Do not touch the power cord or internal components of the water heater with wet hands.**
Doing so may result in electric shock.



CAUTION

- **Do not attempt to repair or replace any part of the water heater, unless it is specifically recommended in this manual.**

For all other service, contact an authorized technician or licensed professional. Improper adjustments, alterations, service, or maintenance may lead to property damage, personal injury, or death and will void your warranty.

- **Do not operate the water heater if you feel something is wrong with it.**
Doing so may result in product damage or personal injury.
- **Do not allow children to operate or access the water heater.**
Doing so may result in product damage or personal injury.
- **Do not attempt to change the water temperature while the water heater is being used.**
Doing so may result in personal injury.
- **Do not turn on the water heater unless the water and gas supplies are fully opened.**
Doing so may damage the water heater.
- **Do not turn on the water if the cold water supply shut-off valve is closed.**
Doing so may damage the water heater.
- **Do not use this water heater for anything other than its intended purpose, as described in this manual.**
- **Do not remove the front cover unless the power to the water heater is turned off or disconnected.**
Failure to do so may result in electric shock.
- **When servicing the controls, label all wires prior to disconnecting them.**
Failure to do so may result in wiring errors, which can lead to improper or dangerous operation.
- **Do not use unapproved replacement or accessory parts.**
Doing so may result in improper or dangerous operation and will void the manufacturer's warranty.
- **Do not place anything in or around the vent terminals, such as a clothes line, that could obstruct the air flow in or out of the water heater.**
- **Should overheating occur or the gas supply fail to shut off, turn off the manual gas valve to the appliance.**
- **Do not use this appliance if any part has been under water.**
Immediately call a qualified service technician to inspect the appliance and to replace any part of the control system and any gas control which has been under water.

2. Product Information

2.1 Product Information

Navien features the new NPE "A" Series tankless gas water heater with a built-in Circulation Pump and Mini Buffer Tank (the NPE "S" series tankless gas water heater features a built-in Mixing Valve). Depending on the heat capacity, each model is divided into two types; 24 and 32.

| Items | NPE | |
|-----------------------------|---|---------------------------------|
| | "A" Models (NPE-24AWE/32AWE) | "S" Models (NPE-24SWE/32SWE) |
| Intended Use | Residential, Commercial or Combi* | |
| Features | Built-in Circulation Pump and Mini Buffer Tank | Built-in Mixing Valve |
| Factory Default Temperature | 49 °C (120 °F) | |
| Gas Type | NG, field-convertible to LP | |

See "3.1 General Specifications" for detailed specifications.

*"Combi" refers to a combination potable water and space heating application. These water heaters cannot be used in space heating-only applications.

2.2 Layout and Key Components

The following diagram shows the key components of the water heater. Component assembly diagrams and particular parts lists are included in the Appendix.

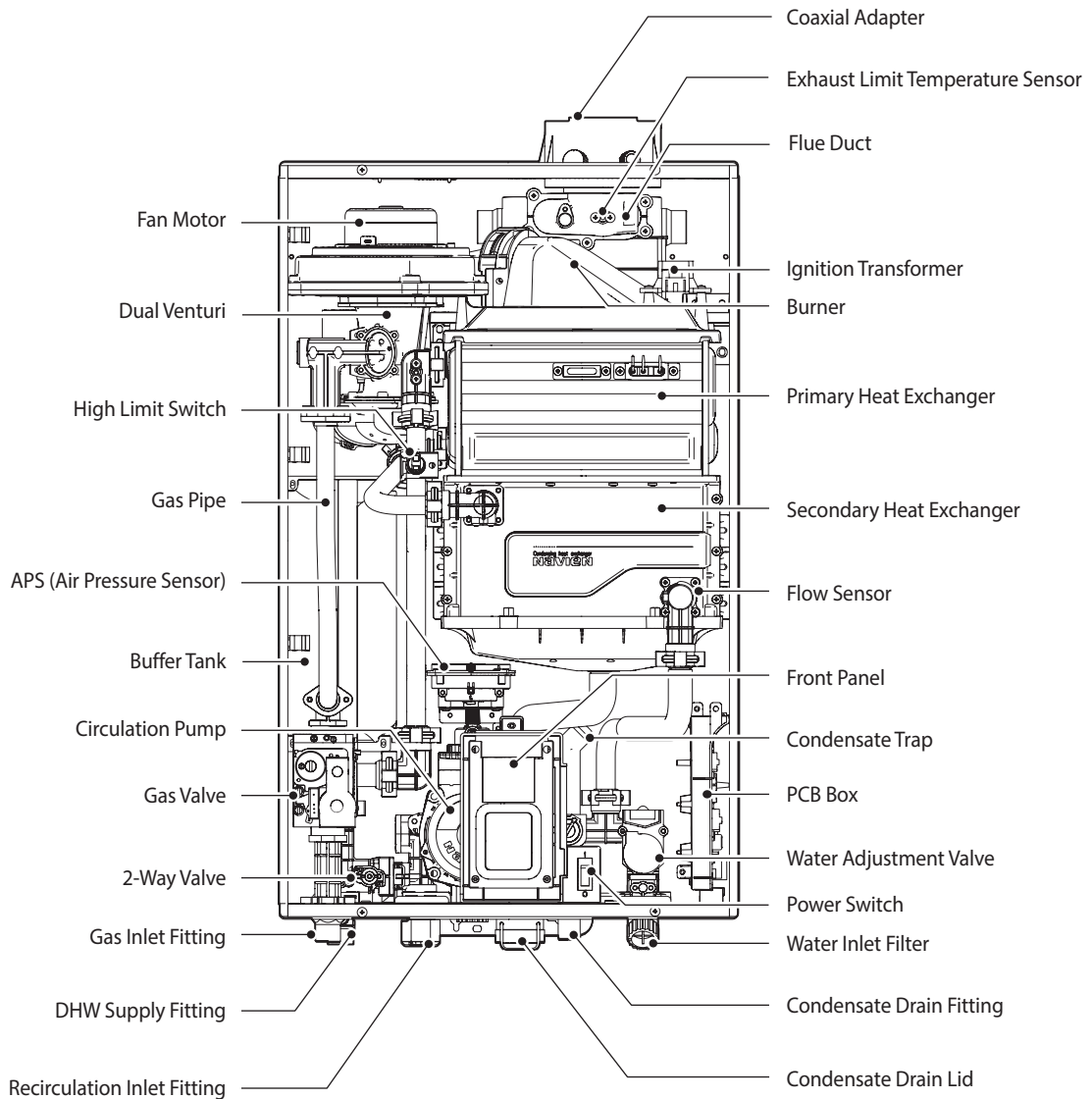

[NPE-24AWE/32AWE]

* Refer to Components Diagram and Part List on page 130.

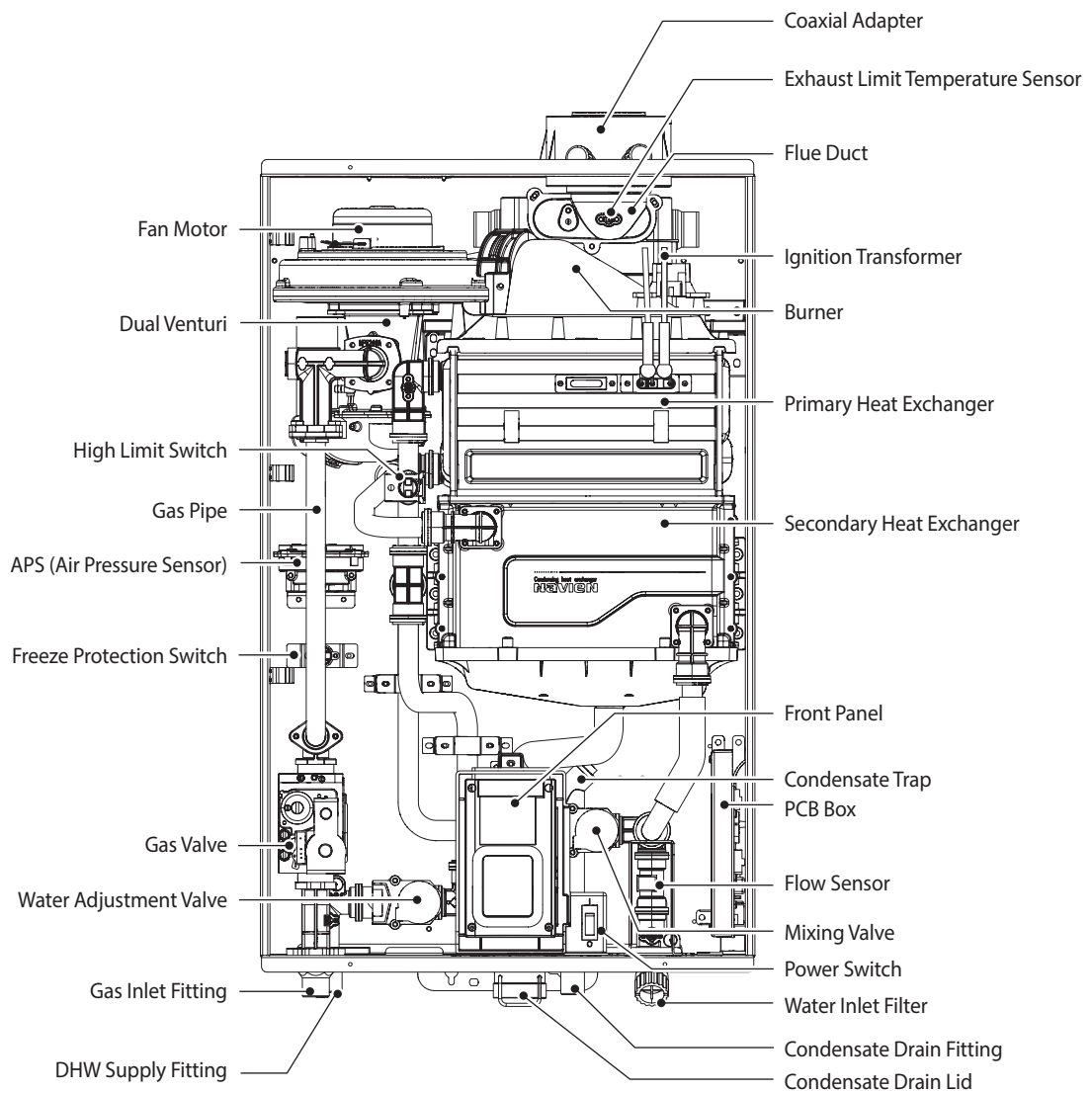

[NPE-24SWE/32SWE]

* Refer to Components Diagram and Part List on page 130.

3. Technical Data

3.1 General Specifications

The following table lists the specifications for the water heater. Additional specifications about water, gas, electric, and air supplies (flue system) appear in the Installation section.

| Specifications | | Unit | NPE-24AWE | NPE-24SWE | NPE-32AWE | NPE-32SWE |
|--|------------------------|-------|--|-----------------|-----------------|-----------------|
| DHW input range | | kW | 39.6 / 4.0 | 39.6 / 4.0 | 52.8 / 5.2 | 52.8 / 5.2 |
| DHW output range | | kW | 42.3 / 4.4 | 42.3 / 4.4 | 56.6 / 5.8 | 56.6 / 5.8 |
| Efficiency at maximum load | | % | 106.6 | 106.6 | 107.2 | 107.2 |
| Efficiency at minimum load | | % | 111.0 | 111.0 | 111.0 | 111.0 |
| DHW Flow Rate at 25°C temp. rise | | l/min | 24.0 | 24.0 | 32.0 | 32.0 |
| DHW Flow Rate at 40°C temp. rise | | l/min | 15.0 | 15.0 | 20.0 | 20.0 |
| Category | | | II2H3P | | | |
| Type | | | Instantaneous hot water production | | | |
| Appliance protection rating | | | IP X5D | | | |
| Min. DHW Working Pressure | | bar | 1.0 | | | |
| Min. DHW Working Flow | | l/min | 1.8 | | | |
| Max. DHW Working Pressure | | bar | 10.0 | | | |
| Adjustable DHW Temperature Range | | °C | 36 ~ 83 | | | |
| Dimensions (Width x Depth x Height) | | mm | 440 x 306 x 695 | 440 x 306 x 695 | 440 x 336 x 695 | 440 x 336 x 695 |
| Weight | | kg | 34 | 30 | 37 | 34 |
| Installation type | | | Wall-mounted | | | |
| Connection diameter | Cold Water Inlet | mm | 22 | | | |
| | Hot Water Inlet | mm | 22 | | | |
| | Gas Inlet | mm | 22 | | | |
| Power Supply | Main Supply | | 230V / 50Hz | | | |
| | Max. power consumption | W | 200W | | | |
| Flue exhaust / Air intake system types | | | B23, B33, B53, C13, C33, C43, C53, C63, C83 | | | |
| Flue exhaust / Air intake system diameters | | mm | Coaxial Ø60/100 and Ø80/125 - Dual duct Ø80/80 | | | |
| Coaxial length Ø60/100 | Max. Horizontal | m | 20 | | | |
| | Max. Vertical | m | 21 | | | |
| Equivalent elbow length Ø60/100 | 90° | m | 2.4 | | | |
| | 45° | m | 1.2 | | | |
| Coaxial length Ø80/125 | Max. Horizontal | m | 68 | | | |
| | Max. Vertical | m | 70 | | | |
| Equivalent elbow length Ø80/125 | 90° | m | 2.4 | | | |
| | 45° | m | 1.2 | | | |
| Equivalent length of adapter Ø60/100 → Ø80/125 | | m | 0.5 | | | |
| Max. dual duct length Ø80/80 | | m | 110 | | | |
| Equivalent elbow length Ø80 | 90° | m | 2.2 | | | |
| | 45° | m | 1.4 | | | |

3.2 Dimensions

The following diagrams show the dimensions of the water heater and the table lists the supply connections.

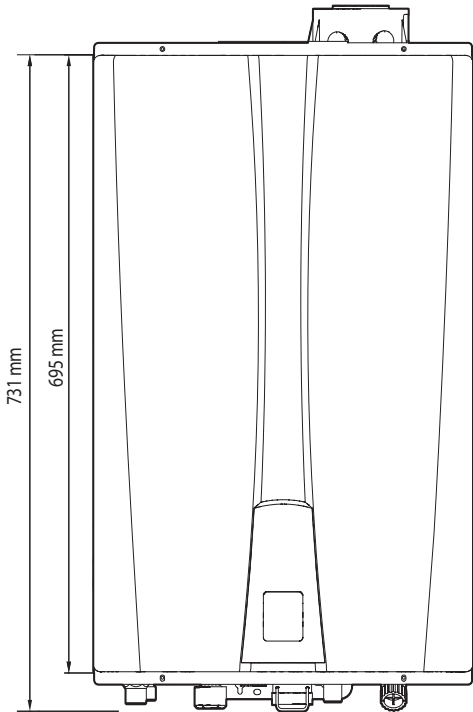

Supply Connections

| | Description | Diameter |
|---|---------------------------|--------------------|
| A | Flue Exhaust / Air Intake | Ø60/100 Ø80/125 |
| B | Hot Water Outlet | 22 mm |
| C | Recirculation Inlet | 22 mm |
| D | Cold Water Inlet | 22 mm |
| E | Gas Inlet | 22 mm |
| F | Condensate Outlet | 15 mm |

Overhead View

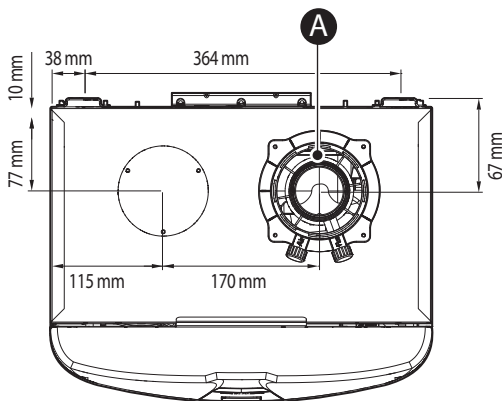

Bottom View

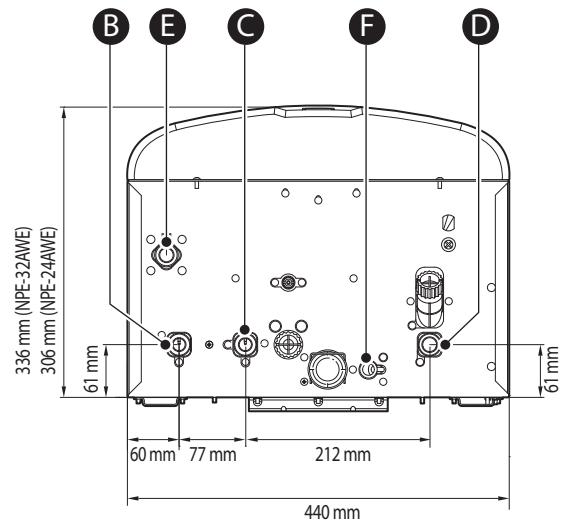

[NPE-24AWE/32AWE]

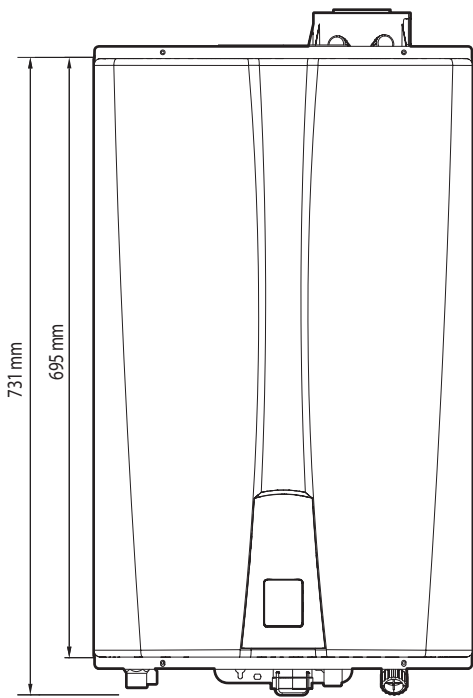

Supply Connections

| | Description | Diameter |
|---|---------------------------|--------------------|
| A | Flue Exhaust / Air Intake | Ø60/100 Ø80/125 |
| B | Hot Water Outlet | 22 mm |
| C | Cold Water Inlet | 22 mm |
| D | Gas Inlet | 22 mm |
| E | Condensate Outlet | 15 mm |

Overhead View

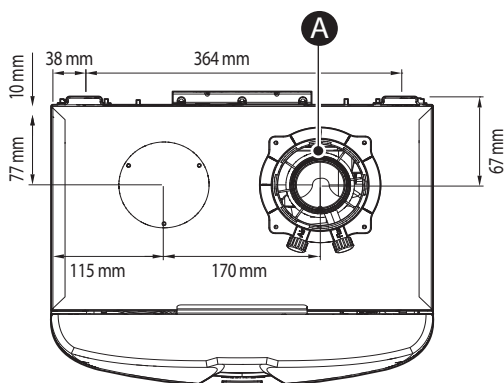

Bottom View

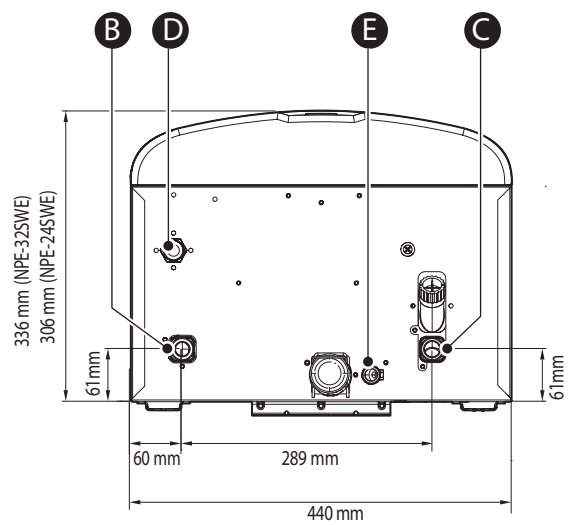

[NPE-24SWE/32SWE]

4. System Details

4.1 Schematic and Flow Diagram

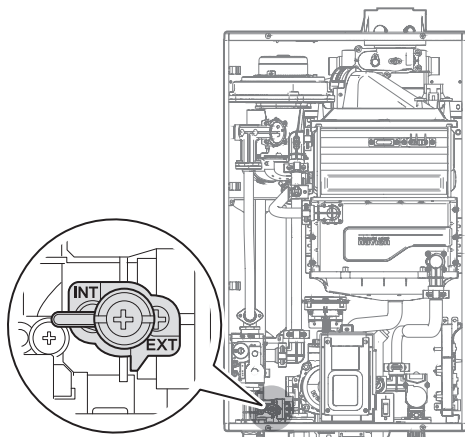

2-way valve open for Internal Recirculation Mode

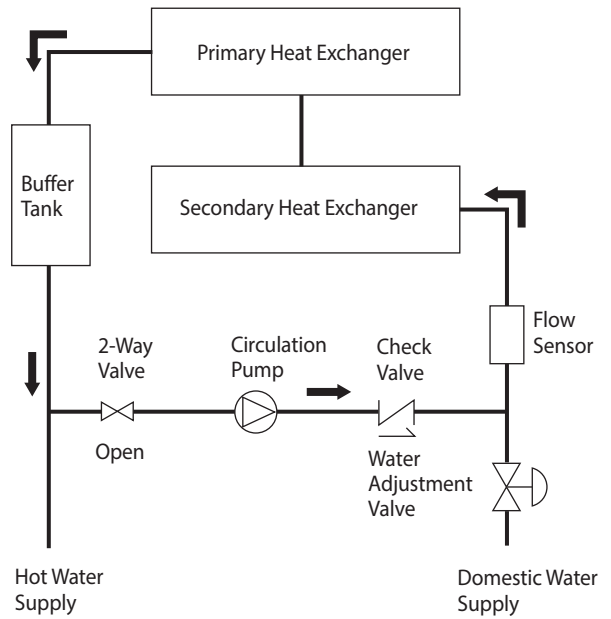

Internal Recirculation Mode

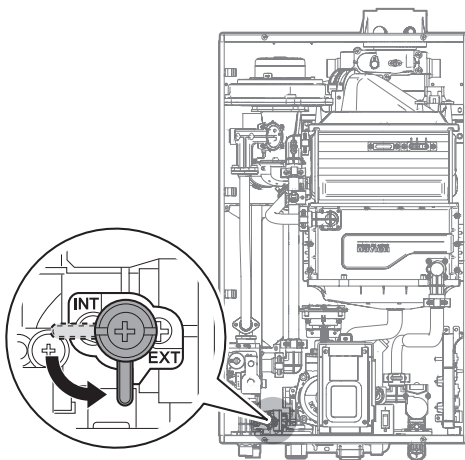

2-way valve closed for External Recirculation Mode

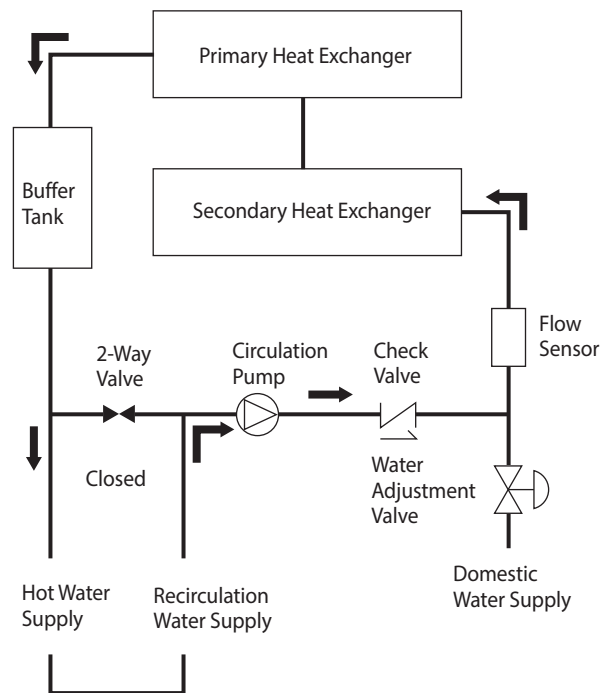

External Recirculation Mode

[NPE-24AWE/32AWE]

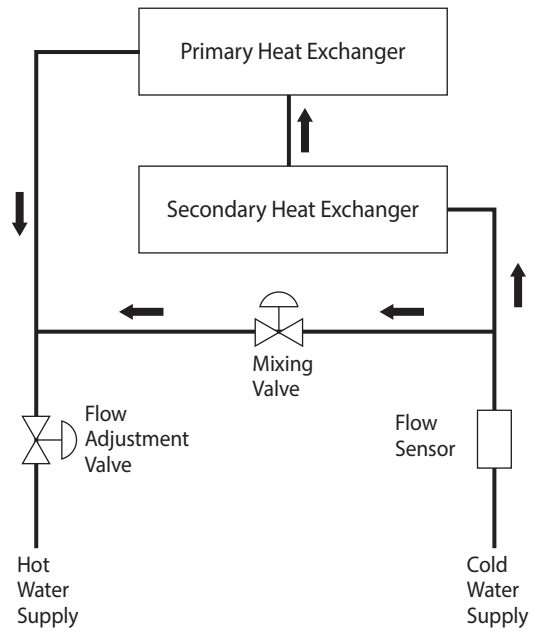
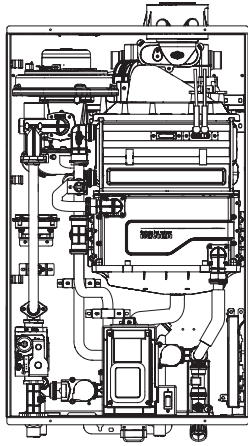

[NPE-24SWE/32SWE]

4.2 Operation Flow Chart

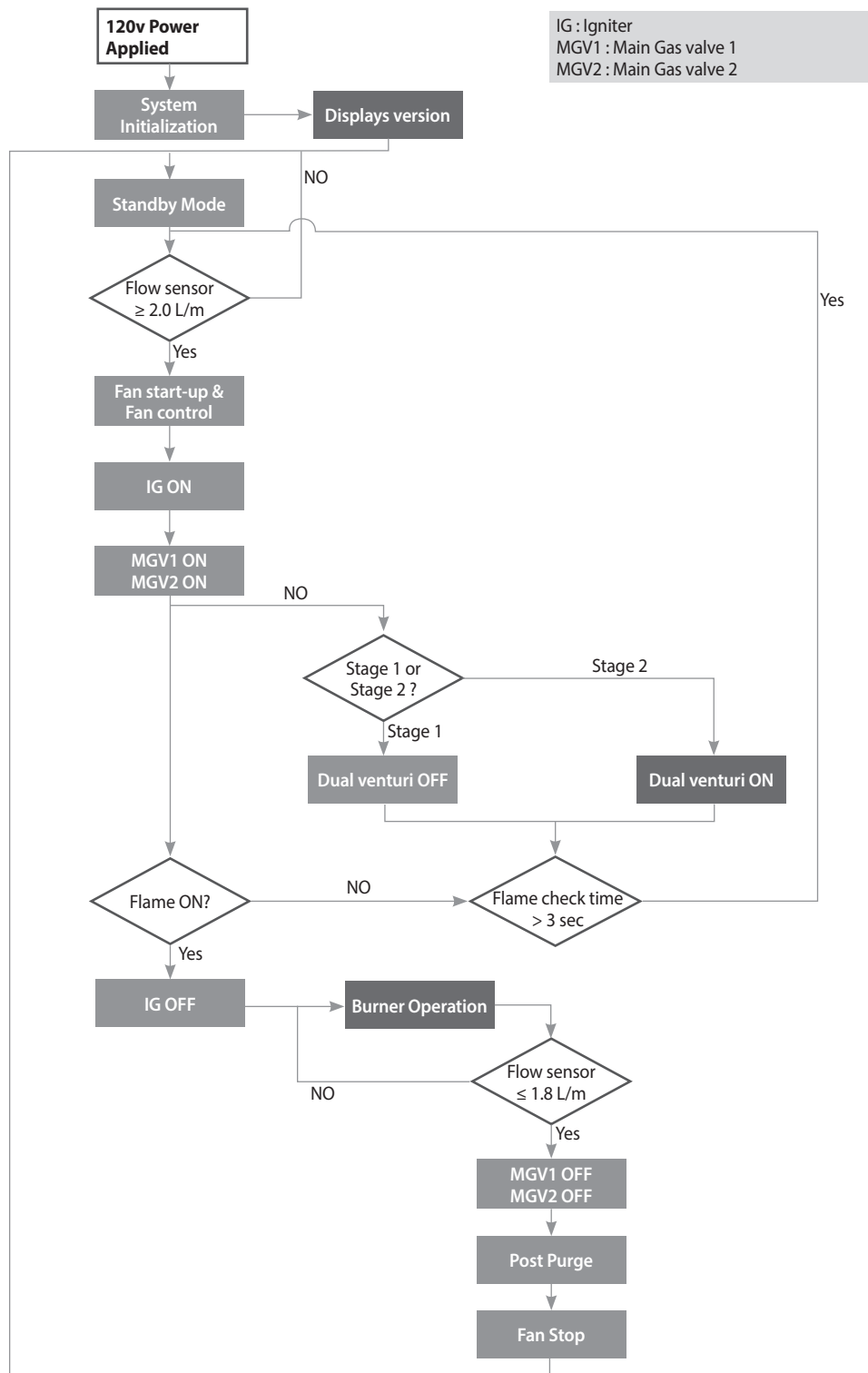

1. Water Flow Begins
 - Water Flow Sensor sends pulses to the PCB when it registers water flow.
 - PCB senses flow greater than 2.0 L/m (approximate).
 - Firing Sequence begins.

2. Firing Sequence
 - PCB monitors Inlet / Outlet water temperature, temperature set point, and water flow rate.
 - Fan Motor activates Purge Cycle in the combustion chamber.
 - Spark igniter begins ignition process.
 - Main Gas control valve opens to minimum fire rate.
 - Flame rod ignition confirms ignition and initial combustion.
 - Spark igniter stops ignition process.

3. Normal Operation
 - PCB monitors flame rod, fan motor frequency, outlet water temperature, PCB temperature set point and water flow rate.
 - Main Gas control valve modulates gas input to required firing rate.
 - Combustion fan speed is adjusted for the required firing rate.
 - Water adjustment valve is adjusted as needed.

4. Shut-down Sequence
 - PCB senses flow rate less than 1.8 L/m (approximate).
 - Main Gas Control valve closes.
 - Water adjustment valve resets to standby position.
 - Fan Motor activates Purge Cycle in the combustion chamber at low speed.

5. Standby Mode
 - PCB monitors water temperature and remote controls.
 - Freeze protection is activated as needed.

4.3 Setting the DIP Switches

The water heater has two DIP switch locations: on the main circuit board (PCB) and on the front panel. Each location has two sets of DIP switches that control the functionality of the water heater. Set the DIP switches appropriately, based on the installation environment and the gas type.

4.3.1 Setting the DIP Switches

The water heater has two DIP switch locations: on the main circuit board (PCB) and on the front panel. Each location has two sets of DIP switches that control the functionality of the water heater. Set the DIP switches appropriately, based on the installation environment.

Circuit Board DIP Switches

The two sets of DIP switches on the circuit board configure the water heater's model settings. These configurations are set at the factory and should not be changed.

Setting the Front Panel DIP Switches

The two sets of DIP switches on the front panel configure the water heater's pump & recirculation, display, well pump, storage tank & solar system, lime alarm, high altitude, Cascade Venting and Gas Type settings. Some of these configurations are set at the factory and should not be changed. The following tables describe the functions of the DIP switches and their settings:

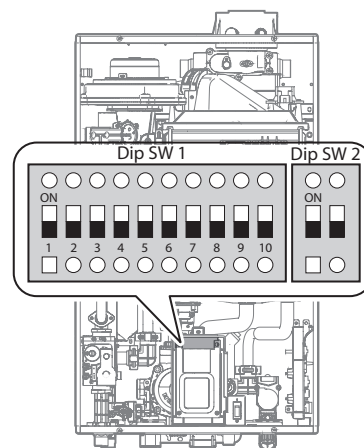

• Dip Switch 1 (set of 10)

| Switch | Function | Setting | | Remark |
|------------------------|---|--|-------------------|---|
| 1-3 | Recirculation Mode - Internal Pump (AWE model Only) | No Recirculation | 1-OFF 2-OFF 3-OFF | <p>*Intelligent Preheating: Learns the user's hot water usage patterns and starts preheating prior to an anticipated draw.</p> <ul style="list-style-type: none"> Preheating starts when remote controller is not connected. When remote controller is connected, preheating starts and operates based on the timer. Set the timer on the remote controller to use hot water at the time of your choice. Intelligent preheating does not function in Cascade Mode (Preheating OFF). Freeze protection is still available with preheating OFF. <p>**External Pump: These settings are to be used when an external pump is wired to the water heater.</p> <p>***Lime Alarm: Displays a "760" error when the set time period has been reached to indicate a flush or service is necessary.</p> |
| | | Internal Recirculation | 1-ON 2-OFF 3-OFF | |
| | | External Recirculation | 1-OFF 2-ON 3-OFF | |
| | | Intelligent Preheating* | 1-ON 2-ON 3-OFF | |
| | Recirculation Mode - External Pump Connected** | External Recirculation (External Pump Only) | 1-OFF 2-OFF 3-ON | |
| | | External Recirculation (with Internal Pump) AWE model Only | 1-ON 2-OFF 3-ON | |
| | | | 1-OFF 2-ON 3-ON | |
| Intelligent Preheating | 1-ON 2-ON 3-ON | | | |
| 4 | - | | | |
| 5 | Well Pump | Well Pump Operation | 5-ON | |
| | | Do not Use Well Pump | 5-OFF | |
| 6 | DHW Storage Tank | Storage Tank Operation | 6-ON | |
| | | Do not Use Storage Tank | 6-OFF | |
| 7-8 | Lime Alarm*** | Do not Use Alarm | 7-OFF 8-OFF | |
| | | 06 months Alert | 7-ON 8-OFF | |
| | | 12 months Alert | 7-OFF 8-ON | |
| | | 24 months Alert | 7-ON 8-ON | |
| 9-10 | Gas Category | G20(LNG)/G30(LPG) | 9-OFF 10-OFF | |
| | | G25(LNG)/G31(LPG) | 9-ON 10-OFF | |
| | | G27(LNG) | 9-OFF 10-ON | |

• Dip Switch 2 (set of 2)

| Switch | Function | Setting | |
|--------|------------------------------------|------------|-----|
| 1 | Cascade Flue (Cascade System Only) | Cascade | OFF |
| | | Individual | ON |
| 2 | Gas Type | LNG | OFF |
| | | LPG | ON |

4.4 Measuring the Inlet Gas Pressure

WARNING

The water heater cannot function properly without sufficient inlet gas pressure. Measuring the inlet gas pressure should be performed by a licensed professional only.

- The inlet gas pressure must be maintained between 3.5" and 10.5" WC for natural gas and between 8.0" and 13" WC for liquefied propane.
- The appliance and its individual shutoff valve must be disconnected from the gas supply piping system during any pressure testing of that system at test pressures in excess of 1/2 psi (3.5 kPa). The appliance must be isolated from the gas supply piping system by closing its individual manual shutoff valve during any pressure testing of the gas supply piping system at test pressures equal to or less than 1/2 psi (3.5 kPa).

To measure the inlet gas pressure:

1. Shut off the manual gas valve on the gas supply line.

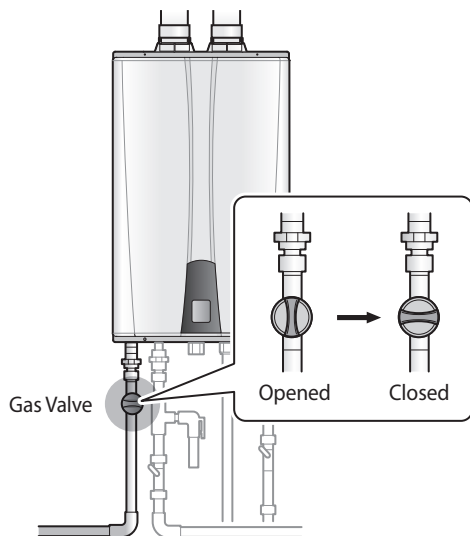

2. Open a hot water faucet. The water heater should turn on and the gas in the gas supply line will be purged.
3. Leave the faucet on until the water heater shuts down due to a lack of gas supply, and then turn off the hot water faucet.

4. Remove the water heater front cover by loosening the 4 Phillips head screws securing it to the case.

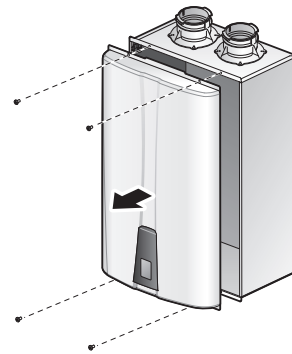

5. Loosen the screw indicated in the figure below and connect a manometer to the pressure port. Reset the manometer to zero before use.

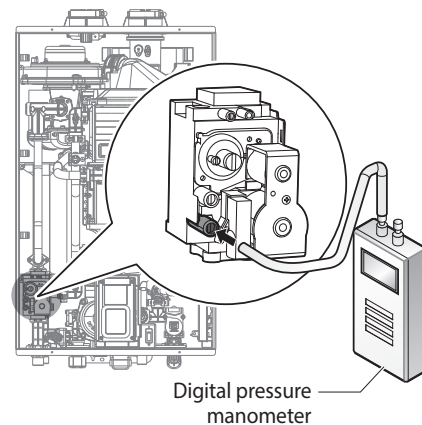

6. Re-open the manual gas valve and check for leaks.
7. Open multiple fixtures that have high flow rates, such as bathtub and shower faucets, to ramp the water heater up to its maximum firing rate.
8. When the water heater reaches its maximum firing rate, check the inlet gas pressure reading on the manometer. The gas pressure must fall within the proper operating range indicated above and in the specifications on page 24.

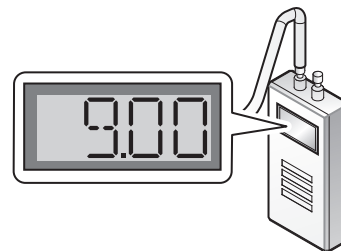

4.4.1 Gas Pipe Sizing Tables

These tables are for reference only. Please consult the gas pipe manufacturer for actual pipe capacities.

Maximum Natural Gas Delivery Capacity

In Cubic Feet (ft³) per Hour (0.60 Specific Gravity; 0.5" WC Pressure Drop). Contact your gas supplier for kcal/m³ ratings. Use 8,900 kcal/m³ for simplified calculations. This table is recommended for supply pressures less than 6" WC.

| Pipe Size | Length (including fittings) | | | | | | | | | | |
|-----------|-----------------------------|-------------|-------------|--------------|--------------|--------------|--------------|--------------|--------------|---------------|---------------|
| | 10' (3m) | 20' (6m) | 30' (9m) | 40' (12m) | 50' (15m) | 60' (18m) | 70' (21m) | 80' (24m) | 90' (27m) | 100' (30m) | 125' (38m) |
| 3/4" | 360 | 247 | 199 | 170 | 151 | 137 | 126 | 117 | 110 | 104 | 92 |
| 1" | 678 | 466 | 374 | 320 | 284 | 257 | 237 | 220 | 207 | 195 | 173 |
| 1 1/4" | 1,390 | 957 | 768 | 657 | 583 | 528 | 486 | 452 | 424 | 400 | 355 |
| 1 1/2" | 2,090 | 1,430 | 1,150 | 985 | 873 | 791 | 728 | 677 | 635 | 600 | 532 |
| 2" | 4,020 | 2,760 | 2,220 | 1,900 | 1,680 | 1,520 | 1,400 | 1,300 | 1,220 | 1,160 | 1,020 |
| 2 1/2" | 6,400 | 4,400 | 3,530 | 3,020 | 2,680 | 2,430 | 2,230 | 2,080 | 1,950 | 1,840 | 1,630 |
| 3" | 11,300 | 7,780 | 6,250 | 5,350 | 4,740 | 4,290 | 3,950 | 3,670 | 3,450 | 3,260 | 2,890 |
| 4" | 23,100 | 15,900 | 12,700 | 10,900 | 9,660 | 8,760 | 8,050 | 7,490 | 7,030 | 6,640 | 5,890 |

In Cubic Feet (ft³) per Hour (0.60 Specific Gravity; 3.0" WC Pressure Drop). Contact your gas supplier for kcal/m³ ratings. Use 8,900 kcal/m³ for simplified calculations. This table is recommended for supply pressures of 6" WC or greater.

| Pipe Size | Length (including fittings) | | | | | | | | | | |
|-----------|-----------------------------|-------------|-------------|--------------|--------------|--------------|--------------|--------------|--------------|---------------|---------------|
| | 10' (3m) | 20' (6m) | 30' (9m) | 40' (12m) | 50' (15m) | 60' (18m) | 70' (21m) | 80' (24m) | 90' (27m) | 100' (30m) | 125' (38m) |
| 1/2" | 454 | 312 | 250 | 214 | 190 | 172 | 158 | 147 | 138 | 131 | 116 |
| 3/4" | 949 | 652 | 524 | 448 | 397 | 360 | 331 | 308 | 289 | 273 | 242 |
| 1" | 1,787 | 1,228 | 986 | 844 | 748 | 678 | 624 | 580 | 544 | 514 | 456 |
| 1 1/4" | 3,669 | 2,522 | 2,025 | 1,733 | 1,536 | 1,392 | 1,280 | 1,191 | 1,118 | 1,056 | 936 |
| 1 1/2" | 5,497 | 3,778 | 3,034 | 2,597 | 2,302 | 2,085 | 1,919 | 1,785 | 1,675 | 1,582 | 1,402 |
| 2" | 10,588 | 7,277 | 5,844 | 5,001 | 4,433 | 4,016 | 3,695 | 3,437 | 3,225 | 3,046 | 2,700 |
| 2 1/2" | 16,875 | 11,598 | 9,314 | 7,971 | 7,065 | 6,401 | 5,889 | 5,479 | 5,140 | 4,856 | 4,303 |
| 3" | 29,832 | 20,503 | 16,465 | 14,092 | 12,489 | 11,316 | 10,411 | 9,685 | 9,087 | 8,584 | 7,608 |
| 4" | 43,678 | 30,020 | 24,107 | 20,632 | 18,286 | 16,569 | 15,243 | 14,181 | 13,305 | 12,568 | 11,139 |

Maximum Liquefied Propane Delivery Capacity

In Thousands of kcal/h (0.5" WC Pressure Drop)

| Pipe Size | Length (including fittings) | | | | | | | | | | | | |
|-----------|-----------------------------|-------------|-------------|--------------|--------------|--------------|--------------|---------------|---------------|---------------|---------------|---------------|---------------|
| | 10' (3m) | 20' (6m) | 30' (9m) | 40' (12m) | 50' (15m) | 60' (18m) | 80' (24m) | 100' (30m) | 125' (38m) | 150' (45m) | 175' (53m) | 200' (60m) | 250' (76m) |
| 1/2" | 291 | 200 | 160 | 137 | 122 | 110 | 101 | 94 | 89 | 84 | 74 | 67 | 62 |
| 3/4" | 608 | 418 | 336 | 287 | 255 | 231 | 212 | 197 | 185 | 175 | 155 | 140 | 129 |
| 1" | 1,150 | 787 | 632 | 541 | 480 | 434 | 400 | 372 | 349 | 330 | 292 | 265 | 243 |
| 1 1/4" | 2,350 | 1,620 | 1,300 | 1,110 | 985 | 892 | 821 | 763 | 716 | 677 | 600 | 543 | 500 |
| 1 1/2" | 3,520 | 2,420 | 1,940 | 1,660 | 1,480 | 1,340 | 1,230 | 1,140 | 1,070 | 1,010 | 899 | 814 | 749 |
| 2" | 6,790 | 4,660 | 3,750 | 3,210 | 2,840 | 2,570 | 2,370 | 2,200 | 2,070 | 1,950 | 1,730 | 1,570 | 1,440 |



NOTE

- For installations using CSST (flexible) gas piping, please refer to the sizing charts provided by the manufacturer.
- The use of single-stage regulators are recommended. Dual-stage regulators could cause operational issues with the water heater.

4.5 Selecting a Recirculation Mode (“AWE” model only)

On all “AWE” model Navien water heaters, you can choose from two pre-heating modes: internal recirculation mode or external recirculation mode. To select a recirculation mode, you must set the DIP switches on the front panel, and set the position of the 2-way valve inside the water heater. By default, the DIP switches are set to OFF.

When the optional ComfortFlow recirculation mode is activated, energy consumption increases because the water heater operates to maintain the water temperature within the circulation loop. You can use the Navien Intelligent Preheating feature, set the timer on the optional Remote Controller to reduce energy consumption.

The recirculation feature of the “AWE” models has three performance advantages:

- Elimination of any minimum flow rate requirement.
- Elimination of any hot/cold/hot stacking—the “cold water sandwich” effect.
- Quicker hot water delivery to fixtures, which results in less water wasted.

Note

When using external recirculation mode with the built-in pump, observe the following maximum recirculation pipe lengths including fittings (22 mm pipe is recommended):

- ½ in Copper Pipe- 30 m of equivalent length
- ¾ in Copper Pipe- 150 m of equivalent length

Lengths in excess of these limits will require an external recirculation pump.

Internal Recirculation Mode

To use the internal recirculation mode:

1. Connect the water supply.
2. Set the 2-way valve inside the water heater to “INT.”

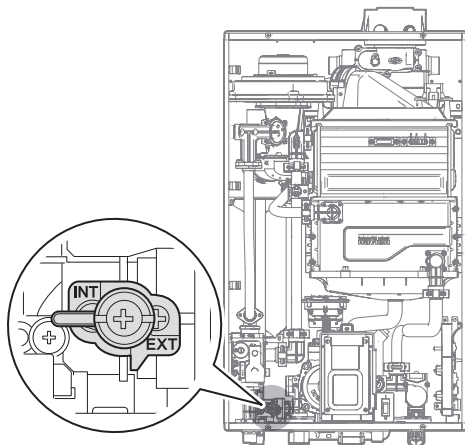

3. Set the front panel DIP switches at the far left (set of 10) to: 1—ON; 2—OFF.

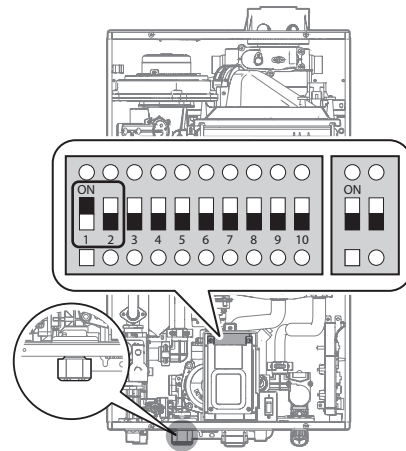

CAUTION

Do not remove recirculation cap. (Internal Recirculation Mode)

The following diagram shows the internal recirculation flow for pre-heating:

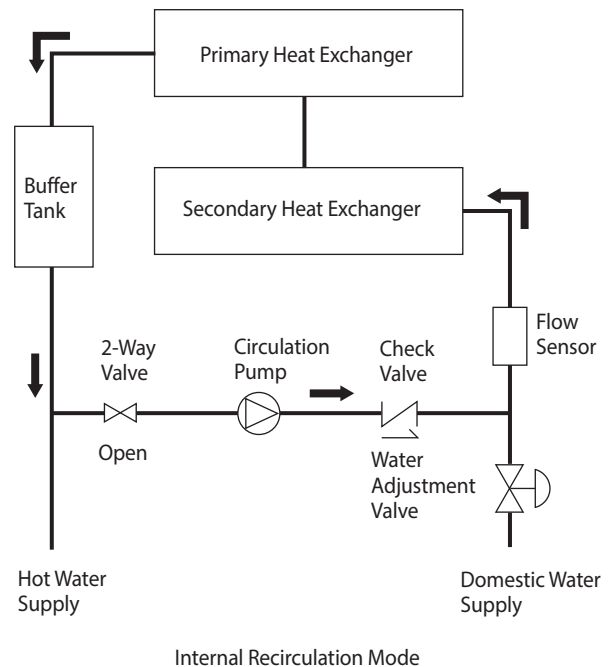

External Recirculation Mode

To use the external recirculation mode:

1. Connect the water supply to support recirculation. Refer to the [NPE-24AWE/32AWE] water piping diagram.
2. Set the 2-way valve inside the water heater to "EXT."

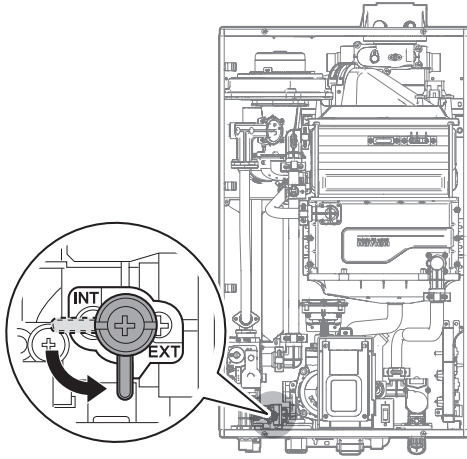

3. Set the front panel DIP switches at the far left (set of 10) to: 1—OFF; 2—ON.

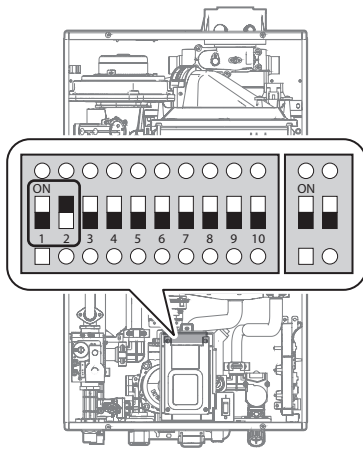

The following diagram shows the external recirculation flow for pre-heating:

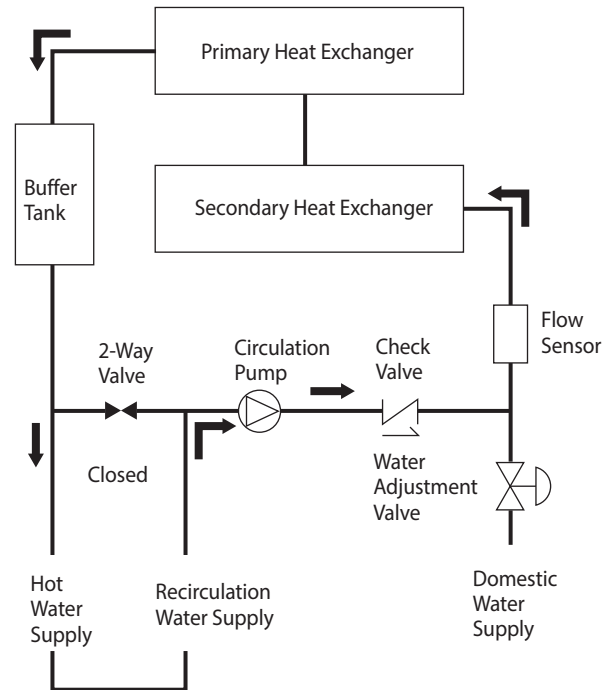

External Recirculation Mode

4.6 Gas Conversion

NPE Series water heaters are configured for Natural Gas from the factory. If conversion to Propane Gas is required, the conversion kit supplied with the water heater must be used.

WARNING

This conversion kit shall be installed by a qualified service agency in accordance with Navien's instructions and all applicable codes and requirements of the authority having jurisdiction. The information in these instructions must be followed to minimize the risk of fire or explosion or to prevent property damage, personal injury or death. The qualified service agency is responsible for the proper installation of this kit. The installation is not proper and complete until the operation of the converted appliance is checked as specified in the manufacturer's instructions supplied with the kit.

Tools Required:

- Phillips Screwdriver
- Flathead Screwdriver
- 5/32" or 4mm Allen Wrench
- Combustion Analyzer or Dual Port Manometer
- Gas Leak Detector

Included Items:

- Gas Orifice (refer to below table)

| Water Heater | NG | | LP | |
|----------------|--------|--------|--------|--------|
| | 1STAGE | 2STAGE | 1STAGE | 2STAGE |
| NPE-24 AWE/SWE | Ø4.80 | Ø6.05 | Ø3.85 | Ø4.75 |
| NPE-32 AWE/SWE | Ø4.80 | Ø6.60 | Ø3.80 | Ø5.00 |

Table 1. Orifice size

- Gas Pressure and Conversion Kit Number Labels

Procedure:

1. Turn off both gas and water supply to the water heater.
2. Using a Phillips hand screwdriver, remove 4 screws (2 from the top and 2 from the bottom) of the front cover assembly to gain access to the internal components. See Figure 1 for illustration of the front cover on the unit.

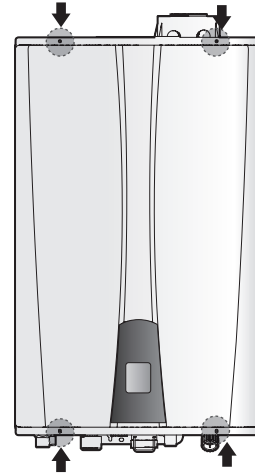

Figure 1. NPE Series Front cover

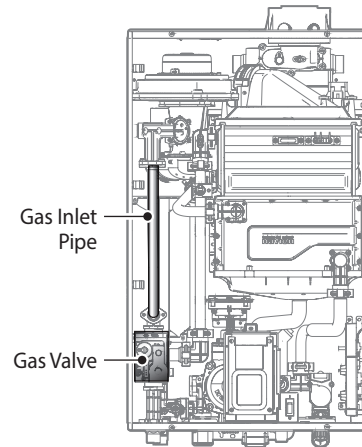

Figure 2. NPE Series Internal Components

3. Once the front cover is removed, place it in a safe location to prevent accidental damage. With the internal components exposed, locate the gas inlet pipe and the Gas Valve near the left side of the unit which are highlighted in Figure 2.
4. Use a Phillips screwdriver to remove the two screws at Location A - the connection below the Gas Valve where it connects to the pipe. See Figure 3 for reference. Once the screws are removed, carefully separate the pipe from the Gas Valve.
5. Once the gas inlet pipe is detached from the Gas Valve, find Location B - the connection above the Gas Valve where it is attached to the Fan Motor Assembly. Carefully remove the four screws by hand using a Phillips screwdriver and pull the Gas Valve away from the Fan Assembly to access the Gas Orifice.

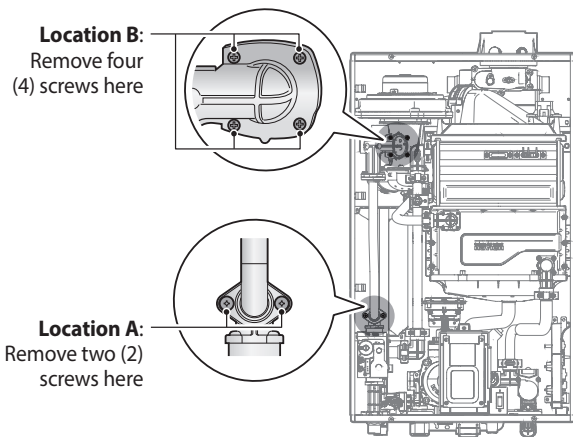

Figure 3. Detaching Gas Valve from Gas Inlet Pipe and Fan Motor Assembly

6. Once the Gas Orifice is exposed, remove the two screws that hold the part in place. Remove the Gas Orifice from its housing and prepare the new Gas Orifice for the LP conversion for installation.

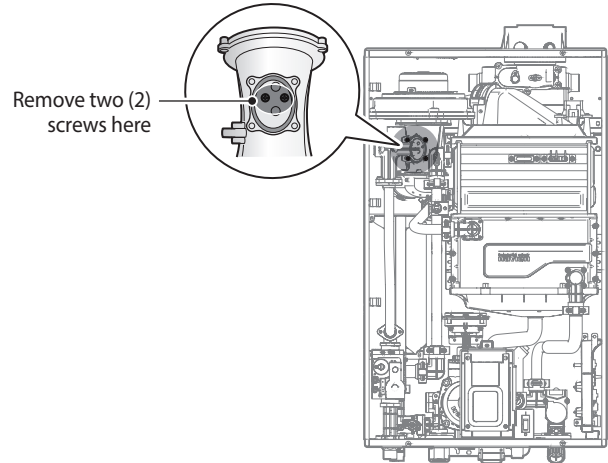
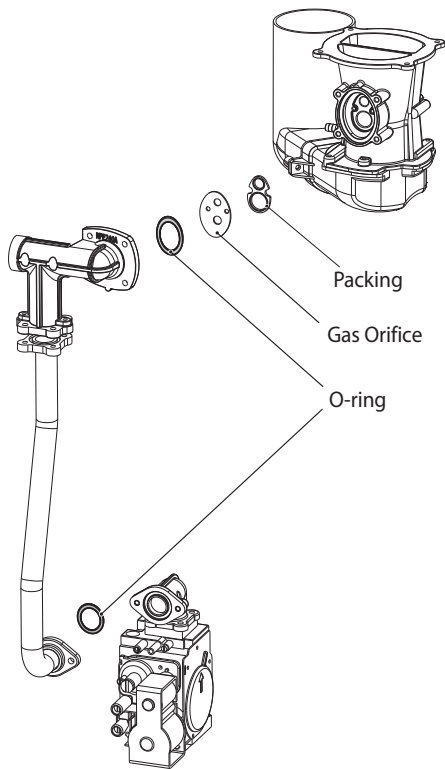

Figure 4. Access to Gas Orifice in Fan Assembly

⚠ WARNING

- DO NOT adjust or attempt to measure gas valve outlet pressure. The gas valve is factory-set for the correct outlet pressure. This setting is suitable for natural gas and propane, requiring no field adjustment.
- Attempting to alter or measure the gas valve outlet pressure could result in damage to the valve, causing potential severe personal injury, death or substantial property damage. Navien water heaters are shipped ready to fire natural gas ONLY.



<NPE-24A/32A/24S/32S>

Figure 5. Exploded view of Gas assembly

! DANGER

See Figure 5. Inspect the O-ring between the gas valve and gas valve inlet adapter whenever they are disassembled. The O-ring must be in good condition and must be installed. Failure to comply will cause a gas leak, resulting in severe personal injury or death.

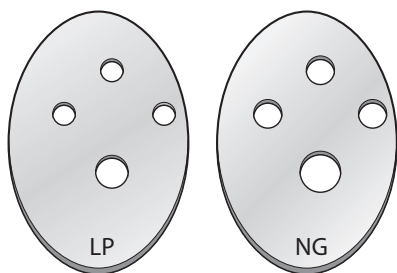

<NPE-24A/32A/24S/32S>

Figure 6. Orifice identification

7. Replace the old Orifice piece with the new part for use with LP gas. Ensure that the Orifice is properly seated inside the port before proceeding to the next step.

8. Replace the gas inlet pipe to its original position and use all screws to secure all connections.

Note Do not overtighten as this may damage or crack the components.

! DANGER

Inspect the O-ring between the gas valve and gas valve inlet adapter whenever they are disassembled. The O-ring must be in good condition and must be installed. Failure to comply will cause a gas leak, resulting in severe personal injury or death.

9. Set the Front Panel Dip switch according to the gas type.

! WARNING

Be sure to turn off the power before changing the DIP switch setting.

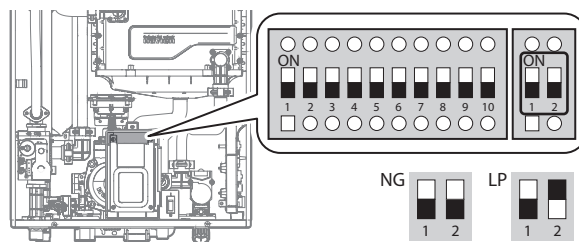

! DANGER

- When conversion is required, be sure to set the Front Panel DIP switches according to the supply gas type.
- Failure to properly set the DIP switches could cause carbon monoxide poisoning, resulting in severe personal injury or death.

10. Turn on the gas and water supply to the water heater.

11. Measure and adjust the gas/air ratio.
 - Option 1. Using Combustion Analyzer (recommended)
 - a. Loosen the screw, rotate the plate and remove the gasket to access the emissions monitoring port as shown in Figure 7.
 - b. Insert the analyzer into the port (Figure 7).

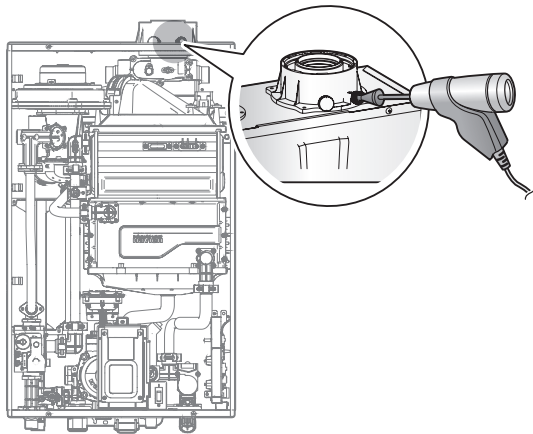

Figure 7. Insert the Analyzer

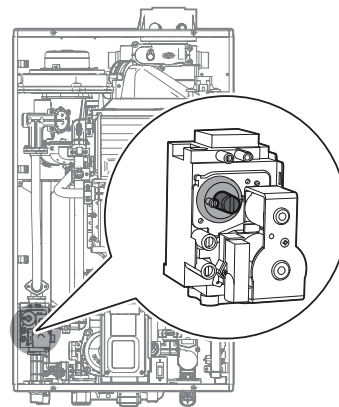

Figure 8. Set Screw Location

| Model | Gas | Max. | Min. |
|-------------------|-------|------------------|------------------|
| | | %CO ₂ | %CO ₂ |
| NPE-24 AWE/SWE | G20 | 9.18 | 9.18 |
| | G25 | 9.18 | 9.49 |
| | G25.1 | 10.63 | 10.53 |
| | G27 | 9.13 | 9.14 |
| | G30 | 11.56 | 10.95 |
| | G31 | 10.65 | 10.18 |
| NPE-32 AWE/SWE | G20 | 9.31 | 9.27 |
| | G25 | 9.40 | 9.30 |
| | G25.1 | 10.45 | 10.35 |
| | G27 | 9.00 | 8.75 |
| | G30 | 11.30 | 11.10 |
| | G31 | 10.48 | 10.18 |

Table 2. CO₂ and CO value

(CO₂ values must be within 0.5% of the values listed.)

- c. Fully open several hot water fixtures and set the water heater to operate at 1-stage MIN mode (refer to page 38). Measure the CO₂ value at low fire. If the CO₂ value is not within 0.5% of the value listed in Table 2, the gas valve set screw will need to be adjusted. If adjustment is necessary, locate the set screw as shown in Figure 8. Using a $\frac{5}{32}$ in or 4 mm Allen wrench, turn the set screw no more than $\frac{1}{4}$ turn clockwise to raise or counterclockwise to lower the CO₂ value.

Note The set screw is located behind the screw-on cover. This must be removed first.

- d. Fully open several hot water fixtures and set the water heater to operate at 2-stage MAX mode (refer to page 38). Measure the CO₂ value at high fire. If the CO₂ values do not match Table 2 at high fire, do not adjust the gas valve. Check for the proper Gas Orifice.

! DANGER

Improper gas valve settings can cause severe personal injury, death or substantial property damage.

4.7 The Front Panel

The front panel allows you to adjust the water temperature and view the operating status or error codes. Remove the protective sheet from the front panel before using it.

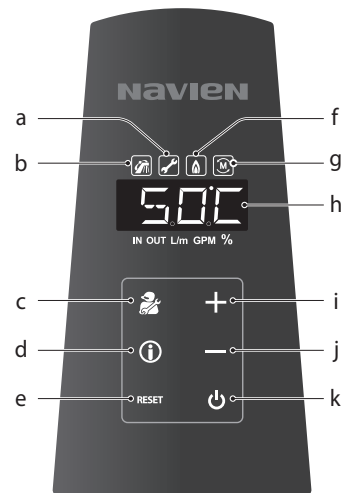

Error

A code will appear on the display



Hot Water Recirculation

Recirculation Mode



Diagnostics button

For installers only



Information button

Shows basic information



Reset button

Resets the water heater (When an error occurs)



Combusting

When the gas burner is on



Master Unit

Cascade operation



Display



Up button

Increases the temperature



Down button

Decreases the temperature



Power button

Turns the water heater on or off

4.7.1 Turning the Water Heater On or Off

To turn the water heater on or off, press the Power button.

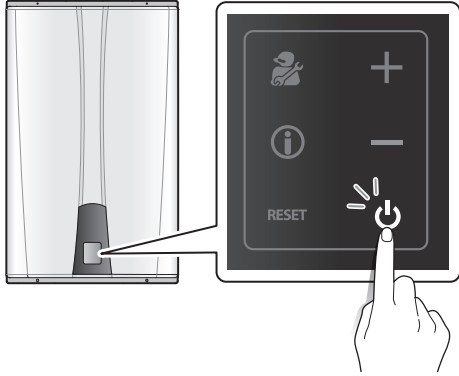

When the power is on, the temperature will appear on the front panel display.



4.7.2 Adjusting the Water Temperature

WARNING

Before adjusting the water temperature, read "Hot water temperature setting" on page 38 carefully. Water temperatures above 50°C can cause instant scalding, severe burns.

The water heater is set to 48.5°C by default. To adjust the water temperature:

1. Make sure that all hot water faucets are closed, and ensure that the internal circulator and any external circulating pumps are off.

NOTE

If a hot water faucet is open, you can adjust the temperature only from 37°C-43°C.

2. Press the + (Up) or - (Down) buttons until the desired temperature appears on the display. You can adjust the temperature while the display is flashing. Once the display stops flashing, the temperature setting is stored.

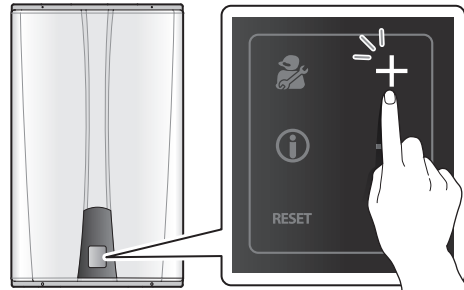

NOTE

The water heater will retain your settings during a power outage.

You can adjust the temperature by the below 5-degree increments, depending on the temperature range:

| Temperature range | Adjusting the water temperature |
|--------------------------|---|
| 36°C-50°C (Celsius mode) | 0.5°C increments |
| 50°C-60°C (Celsius mode) | Press for 2 seconds to adjust in 2°C increments |

The water heater will not provide hot water instantly at the hot water faucet unless a recirculation line has been installed from the furthest fixture back to the water heater. For "A" models, the unit must be set to "external recirculation" mode.

4.7.3 Using Commercial Mode

To use water above 60°C (up to 83°C), you can use Commercial Mode.

- To enter Commercial Mode: Press the up (+) and down (-) button simultaneously for 10 seconds. "HIGH" appears on the display.
- To exit Commercial Mode: Press the up (+) and down (-) button simultaneously for 10 seconds. "LoW" appears on the display.



NOTE

To adjust the temperature, press the up (+) button for 5 seconds to adjust in 5°C increments.

4.7.4 Viewing Basic Information

To view information about the water heater, press the Information button.

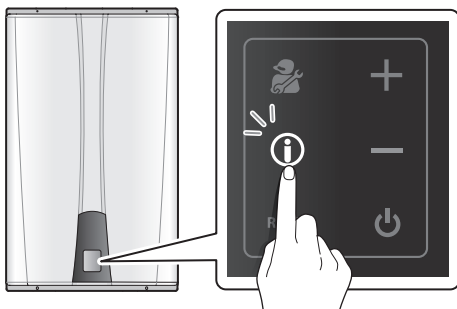

Press the + or - buttons to switch between the information types.

| Display | Description |
|---------|---------------------------------------|
| | Flow rate in litres per minute (LPM). |
| | Hot water outlet temperature (OUT). |
| | Cold water inlet temperature (IN). |

To exit information mode, press the Reset button.



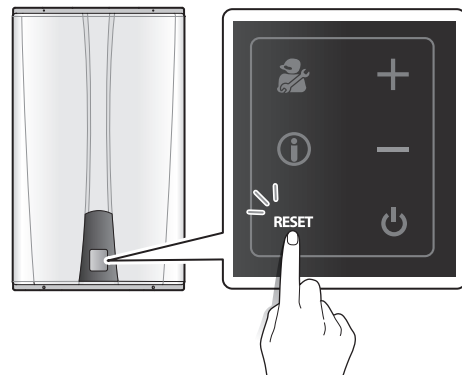

4.7.5 Resetting the Water Heater

If an error message appears, you can try resetting the water heater to resolve the problem. To reset the water heater, press the Reset button.



If resetting the water heater does not solve the problem, refer to the Troubleshooting section of this manual or contact Technical Support at 1-800-519-8794.

4.7.6 LCD display

| DISPLAY | Function description | Remark |
|--|--|---|
|  Preheating icon | <p>Displays when a recirculation mode is activated.</p> <p>When the remote controller is not connected: Preheating will operate based on the setting of the DIP switches on the front panel.</p> <p>When the remote controller is connected: Preheating will operate based on the timer settings of the remote controller (recirculation mode must be selected on the front panel)</p> <p>When the AHU is connected: The preheating function of NPE will be turned off, and the AHU heating icon will be displayed instead of the preheating icon.</p> | Preheating setting |
|  Error icon | <p>Displays an error icon when an error occurs.</p> <p>When operation is maintained but an error is only displayed, the basic operation (temperature setting, etc.) is normally possible. However, at this time, it is impossible to adjust the setting temperature if hot water is in use.</p> | Error situation flashing Error history off |
|  Combustion icon | <p>Displays during a combustion cycle.</p> <p>The combustion icon flashes at intervals of 1 second when the water heater is operating to prevent freezing.</p> | Flame signal state display |
|  Master icon | <p>Displayed on the Master unit in a cascade system.</p> <p>Master: ON, Slave: OFF</p> | On at Master |
| Segment | Displays data according to each setting and display condition on 4 segments. | |
| IN OUT | <p>When displaying the cold water inlet temperature: IN displayed</p> <p>When displaying the hot water outlet temperature: OUT displayed</p> | Displayed in information mode |
| L/M | The unit icon displays the current flow rate (in liters/min) | With display units set to °C. |
| GPM | The unit icon displays the current flow rate (in gal/min) | With display units set to °F. |
| % | The unit icon is displayed when indicating the percentage of a parameter. | |

| Segment state display | Function | Remark |
|-----------------------|--|--------|
| WAIT | Displayed while waiting for a response from the main controller when executing a command | |
| RST | Displayed during an alarm or error reset | |
| CLR | Displayed when deleting the Error History or Tech Info | |
| INIT | Displayed when initiating a Factory Reset | |

4.7.7 Button

| | | | | | | |
|---------------------|---|---|---|--|---|---|
| Button |  |  |  |  |  |  |
| Description or name | Diagnostic | Reset | Power | Information | Plus | Minus |

| Short Key | Function | Remark |
|------------------------|---|--------|
| [Diagnostic] short key | Display of information for service | |
| [INFO] short key | Display/confirmation of information for consumers | |
| [RESET] short key | Error code release/reset | |
| [PLUS] short key | Item movement/UP | |
| [MINUS] short key | Item movement/DOWN | |

| Long Key combination | Function | Remark |
|---|--|---|
| [POWER] long key(1 sec) | Power ON/OFF | |
| [INFO] long key(2 sec) | Error history display | Must be in Normal mode or Error Display mode |
| [RESET] long key(5 sec) | Individual deletion of Error History /Tech Data | Works only at the relevant mode |
| [Diagnostic] long key(5 sec) | Advancement into Test Menu | Must be in Normal mode |
| [Diagnostic] long key(10 sec) | Version display | Power turned OFF |
| [PLUS] + [MINUS] long key (10 sec) | High temperature water setting/release(NPE-240A only) | Allows temperature settings above 60 °C (140 °F) |
| [Diagnostic]+[PLUS] long key(5 sec) | Cascade: assigns master unit and completes set-up | Possible at Normal mode |
| [Diagnostic]+[MINUS] long key(2 sec) | Cascade: assigns slave unit | |
| [Diagnostic]+[RESET] long key(5 sec) | Cancels cascade operation (from master unit) / removes individual slave unit from cascade system | Possible at Normal mode with Cascade operation activated |
| [Diagnostic]+[POWER] long key(5 sec) | Cascade system power ALL ON/OFF | Possible only at Master, and possible only with power turned OFF or at a Normal Operation condition |
| [Diagnostic]+[PLUS]+[RESET]+[POWER] long key(5 sec) | Factory reset | Possible only with power turned OFF |



* While buttons are being pressed on the front panel, the keypad will remain lit to its maximum brightness. After pressing a button, the keypad will dim to medium brightness for 5 seconds, then dim to minimum brightness for 5-10 seconds and then completely turn OFF 10 seconds later.

* Button entries are recognized after pressing for a short period (50msec) and then releasing.

* If a button is pressed and held for a longer time as specified in the above chart, it will be recognized as a "long key" function.

4.7.8 Power ON/OFF

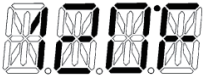
1. Turn the power ON/OFF by pressing the [POWER] button for about 1 sec.
2. If the unit is experiencing an error, the error code will continue to display on the front panel even if the unit is turned OFF.





| Item | Description | Display method |
|-----------|--|--|
| Power ON | Normal operation mode with power turned ON | Power ON: When the setting temperature is 120 °F (Fahrenheit specification)  |
| | | Power ON: When the setting temperature is 60.0 °C (Celsius specification)  |
| Power OFF | Power OFF condition with power turned OFF | Power OFF: DISPLAY ALL OFF except the state icon (The state icon is normally displayed depending on conditions) |

* If power is initially applied, the panel is turned ON for 2 seconds. (To check whether the LCD is defective)

4.7.9 Normal operation

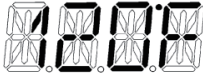
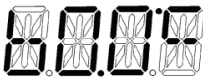
1. Turn the water heater ON by pressing the [Power] button for approximately 1 second.
2. The setting temperature will be displayed.
3. Under the usage of AHU & Outdoor sensor, when DHW is off and space heating is on, the current heating temperature based on the AHU outdoor temperature will be displayed, and when space heating is off, DHW temperature setting will be displayed.
4. When an alarm occurs, the "A.760" code and the setting temperature are toggled and displayed at intervals of 1 second.
5. While an alarm occurs, press the [Reset] button for over 2 seconds to display "RST" and then release the alarm.

6. When a level1 error occurs, the error icon flashes for 1 second and the error code and the setting temperature are toggled and displayed at intervals of 1 second (Level 1 Error = An error that can be reset without turning the power OFF then ON).
7. Press the [Reset] button once for a level1 error so that "RST" is displayed for 3 seconds and the error is released when the error release condition is satisfied.
8. The water heater will function normally during an alarm or level1 error.

| Item | Description | Display method |
|-------------------------|---|--|
| Normal condition | Normal operation mode with power turned ON | When the setting temperature is 120 °F (Fahrenheit specification)  |
| | | When the setting temperature is 60.0 °C (Celsius specification)  |
| Alarm occurrence | When a lime alarm period set with a dip switch is reached |  ↕ 1 sec flashing  |
| Level1 error occurrence | When a level1 error occurs |  ↕ 1 sec flashing  |

4.7.10 Setting the Operation Mode

1. Using the Front Panel, press and hold the Diagnostics Button for over 5 seconds until "1.TST" is displayed.
2. Press the + (Up) button once to change the display to "2.OPR".
3. Press the Information Button once to access the Operation Mode menu.
4. Press the + (Up) button once to set the water heater to operate at 1-stage MIN ("MIN.1").
5. To set the water heater to operate at 2-stage MAX, press the + (Up) button 3 times or until "MAX.2" is displayed.
6. To exit the Operation Mode and return the water heater to normal operation, press the Reset button twice.



4.7.11 Error display and reset

1. Depending on the severity of the issue that is causing the error, the water heater will either stop its operation or will only be able to perform basic operations. A flashing red error icon can be seen on the front panel along with the associated error code.
2. When an error occurs while accessing other modes on the front panel, press [RESET] to access the <error display mode> while the error icon is flashing in order to view the error code.
3. While the panel is in the <error display mode>, the error icon and code will flash in rotation at 1 second intervals.

4. The error code is displayed in 3 digits. (see below)



5. While in the <error display mode>, it is possible to access the User Info, Service Info, Error History and Component Test mode.
6. Press the [RESET] button once with the error code displayed to reset the water heater. The front panel will display "RST" for 3 seconds and then release the error if the cause of the error has been resolved.
7. If it is impossible to release the error, the error code will display after 3 seconds.

4.7.12 Hot water temperature setting

1. At the <Normal operation mode>, press the [+] or [-] button to access the <hot water temperature control mode>.
2. If the <hot water temperature control mode> is displayed, the temperature setting value flashes. → The temperature value is displayed while the temperature is being set.
3. Adjust the temperature with the [+] / [-] button. (Operated depending on the temperature range: See the following table below).
4. Pressing the [+] / [-] button for over 2 seconds acts as a continuous key and will rapidly adjust the temperature.
5. It is impossible to increase the temperature above 43 °C (110 °F) while using the hot water (or only when at least 1 unit is using hot water in a cascade system).
6. For high temperature applications, press the [+] + [-] button for over 10 seconds to access temperature settings above 60 °C (140 °F). ("HIGH" or "LOW" displayed for 2 seconds after setting)
7. Press the [Info] or [Reset] button once to return to the <Normal operation mode>. (The temperature setting value is maintained according to its last setting.)
8. If there is no button input for 5 seconds, then it automatically returns to the <Normal operation mode>. (The temperature setting value is maintained according to its last setting.)

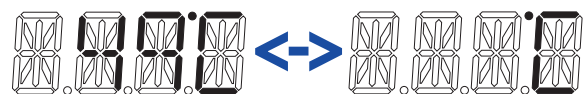



US/Canada specification

| Temperature range | Increase/ decrease value | [+] key | [+] continuous key operation | [-] key | [-] continuous key operation |
|-----------------------|-----------------------------|---------------|------------------------------|-----------|------------------------------|
| 36~50 °C (98~120 °F) | 0.5 °C | Short key | Increased every 100msec | Short Key | Decreased every 100msec |
| 50~60 °C (120~140 °F) | 2 °C | 2sec Long Key | Not working | Short Key | Decreased every 100msec |
| 60~83 °C (140~182 °F) | 5 °C 80°C <-> 83°C | 5sec Long Key | Not working | Short Key | Decreased every 100msec |

4.7.13 Viewing Basic Information

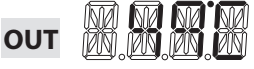
1. At the <Normal operation mode>, press the [Info] button once to access the Information Data.
2. Whenever the [+] / [-] button is pressed, the Information Data item can be selected and displayed.
3. The data items being currently outputted are displayed by an LED ICON. (Flow rate-GPM/LPM, leaving water temperature-OUT, entering water temperature-IN)
4. Press the [Reset] button once to return to the <Normal operation mode>.
5. If there is no button input for 5 minutes, it automatically returns to the <Normal operation mode>.

| Item | Description | Display method |
|-------------------|--|--|
| Flow rate | <ul style="list-style-type: none"> • Display of the current flow rate • Minimum display unit: 0.2 Gal/min or l/min | LPM flow rate display ex) 38.6 L/m  |
| Water temperature | <ul style="list-style-type: none"> • Gal/min or l/min • Display of the current outgoing water temperature | OUT temperature display ex) 49 °C  |
| | <ul style="list-style-type: none"> • Display of the current incoming water temperature | IN temperature display ex) 49 °C  |

4.7.14 Error occurrence history display

1. At the <Normal operation mode> or <Error display mode>, press the [Info] button for over 2 seconds to access the error history mode. The most recent error will be displayed first.
2. When the [+] / [-] button is pressed, the error history can be searched. A total of 10 errors are stored in memory and are labeled from 0 to 9 with 0 being the most recent error.
3. Whenever the [Info] button is pressed, the previous error occurrence time difference(unit time, maximum 9999 hr) and the sub error code are toggled and displayed.
4. Pressing the [Reset] button for 5 seconds while in the <ERROR HISTORY DISPLAY MODE> displays "CLR" and deletes all the ERROR HISTORY DATA.
5. Press the [Reset] button once to return to the <Normal operation mode>.
6. If there is no button input for 5 minutes, then it automatically returns to the <Normal operation mode>.

While in <ERROR HISTORY DISPLAY MODE> the first digit indicates the history of the error with 0 being the most recent. The remaining 3 digits indicate the error code. If there is no error history, a "0" will be displayed.
Passed time display: The time between the currently displayed error and the just previously generated error is displayed in 1-hr unit. (0 is displayed if the error code is empty)

Ex) When the most recent error code is 615, the sub error code is 5, and 24 hours have passed since the error was generated.

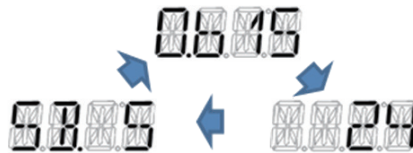











- When the Sub Error Code is 0(i.e., there is no sub error code), the display is as follows:

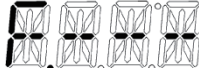



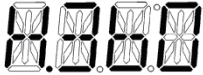

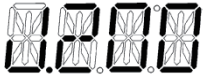
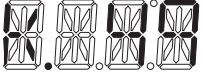



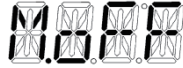
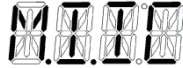
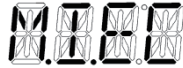
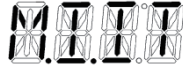

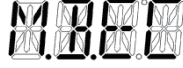
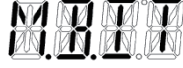
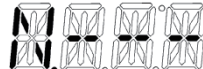

4.7.15 Service information display

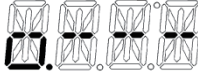

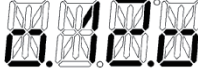
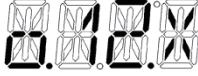



1. At the <Normal operation mode>, press the [Diagnostic] button once to access the service information display.
2. Press [+] or [-] to navigate through the user parameters.
3. Item of current SERVICE Information Data is indicated as an alphabetical numbering on the first segment and relevant DATA value is indicated at the 2nd, 3rd and 4th segment. (Alphabetical numbering A~Z are indicated and next ones and indicated as 1~9, then those after that are indicated as symbols.)
4. Press the [Reset] button once to return to the <Normal operation mode>.
5. If there is no button input for 1 hour, then it automatically returns to the <Normal operation mode>.
6. The proper units are indicated with the LCD ICON for the applicable input items (Example: Water pressure - psi).

| Item | Description | Display method |
|-------------------------------------|--|---|
| (A)Flow rate | Display of the current flow rate Minimum display unit : 0.2 Gal/min or l/min | LPM flow rate display ex) 38.6 L/m  |
| (B)Hot Water Outlet temperature | Display of the current outgoing water temperature | OUT temperature display ex) 49 °C  |
| (C)Water Inlet temperature | Display of the current incoming water temperature | IN temperature display ex) 120 °F  |
| (D)Heat Capacity | Display of current heat capacity % | % Heat capacity display in percentage ex) 92 %  |
| (E)Water adjustment valve condition | Display of the water adjustment valve condition(%) Fully closed= 100% Fully opened= 0% | % display of the valve close ratio in percentage ex) When closed 24 %  |
| (F)Mixing valve condition | Mixing valve condition display(%) Fully closed= 0% Fully opened= 56% | "A" models  |
| | | "S" models: % display of the valve close ratio in percentage ex) When closed 46 %  |

| Item | Description | Display method |
|-----------------------------|---|--|
| (G)Heat exchanger flow rate | Calculated value by the mixing valve open condition from the total flow rate For "A" models, this flow will be the same as (A) | LPM flow rate display ex) Relevant flow rate: 20.4 L/m  |
| (H)Current RPM | Fan motor RPM display | Display of RPM by omitting the last digit ex) 3600rpm  |
| (I) Current APS | APS voltage value display | Display of the APS value as voltage up to the first decimal place ex) 3.2V  |
| (J)Flame condition | Flame detection current AD value display Flame On: 8bit AD value less than 70 Flame Off: 8bit AD value more than 175 | Display of the flame detection AD value 0~255 ex) 200  |
| (K)Exhaust gas temperature | Current exhaust gas temperature display | Exhaust gas temperature display ex) 49 °C  |
| (L)Model and capacity | Currently set model and capacity display The 2nd & 3rd digits represent the model and the 4th digit represents the type of unit. | ex) Capacity 180, Condensing  |

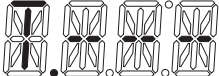
| Item | Description | Display method |
|---|---|---|
| <p>(M)Recirculation setting information</p> <p>* 2nd letter: Pump I: Internal Pump E: External Pump B: Both (Internal & External) Pump</p> <p>* 3rd, 4th letters: Circulation, Intelligent Preheat EC: External Circulation IC: Internal Circulation IT: Intelligent Preheat</p> | <p>Displays the recirculation mode that has been selected on the front panel.</p> | <p>Preheating not working</p>  |
| | | <p>Internal pump, internal circulation</p>  |
| | | <p>Internal pump, external circulation</p>  |
| | | <p>Internal pump, intelligent preheating</p>  |
| | | <p>External pump, external circulation</p>  |
| | | <p>Internal pump and external pump, internal circulation</p>  |
| | | <p>Internal pump and external pump, external circulation</p>  |
| | | <p>Internal pump and external pump, intelligent preheating</p>  |
| <p>(N)Number of currently working cascade units</p> | <p>Number of actually working units in the current cascade system</p> | <p>CASCADE OFF</p>  |
| | | <p>CASCADE ON: Display of the number of working units Ex) 8 units working</p>  |

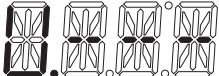
| Item | Description | Display method |
|----------------------------------|--|---|
| (O) Cascade information | Cascade ON/OFF condition display Individual Master/Slave number and operation condition display Segment display: ID+o(ON)/X(OFF) | CASCADE OFF  |
| | | CASCADE ON: MASTER UNIT, standby ON  |
| | | CASCADE ON: MASTER UNIT, standby OFF  |
| | | CASCADE ON: SLAVE UNIT, standby ON ex) ID 12  |
| | | CASCADE ON: SLAVE UNIT, standby OFF ex) ID 12  |
| (P) Information on gas type | Displays the current gas <panel version : after v1.3> | NG  |
| | | LPG  |
| (Q) Altitude setting information | Displays the current altitude level setting <panel version : after v1.5> | 0~2,000ft  |
| | | 2,000~5,400ft  |
| | | 5,400~7,700ft  |
| | | 7,700~10,100ft  |

| Item | Description | Display method |
|--|--|---|
| (R) Heat exchanger outlet temperature | Display of the current outlet temperature (Applies to Front panel version V1.6 (July 23, 2013) or later versions only) | OUT temperature display ex) 49 °C  |
| (S) Heat exchanger inlet temperature | Display of the current inlet temperature (Applies to Front panel version V1.6 (July 23, 2013) or later versions only) | IN temperature display ex) 49 °C  |
| (T) AHU outdoor temperature | Displays the current AHU outdoor temperature. | AHU Off or AHU Outdoor Off  |
| | | AHU On & AHU Outdoor On ex) 49 °C  |
| (U) Heating temperature based on the AHU outdoor temperature | Displays the current heating temperature based on the AHU outdoor temperature. | AHU Off or AHU Outdoor Off  |
| | | AHU On & AHU Outdoor On ex) 49 °C  |

4.7.16 Test information menu

1. At the <Normal operation mode>, press the [Diagnostic] button for over 5 seconds to access the <TEST INFORMATION MENU MODE>.
2. Select the desired test mode in the INFORMATION MENU using the [+] / [-] button.
3. Press the [Info] button once to get into the currently displayed item mode.
4. Press the [Reset] button once to return to the <Normal operation mode>.
5. If there is no button input for 5 minutes, then it automatically returns to the <Normal operation mode>.

| Item | Description | Display method |
|----------------------------------|--|----------------|
| Component check mode | Used to test the normal operation of each device | |
| Operation condition setting mode | Used to test the operation condition of the water heater | |

4.7.17 Component Check

1. While in <TEST INFORMATION MENU MODE>, press the [+] / [-] button and then press the [Info] button once 1.TST is displayed on the front panel.
2. After accessing <Component check mode>, make sure that the water heater is not operating (stop flow).
3. Increase/decrease and change the component check menu item with the [+] / [-] button.
4. For an item not supported by the current model, do not display the item but skip it. (Depending on the DIP SW setting of the main controller)
5. Press the [Info] button once to display "WAIT", execute the component check operation for the relevant item, and return to the <trouble check mode> after operation ends. (Excluding the Dual Venturi Test)
6. During the component check operation, a test is automatically performed without pressing additional buttons (except for Dual Venturi test).
7. The Dual Venturi Test function is to perform an On/Off manual operation test with the [+] , [-] buttons, and if the [Reset] button is pressed or there is no key input for 5 minutes, then it returns to the "D.VEN" display item.

8. Press the [Reset] button once to return to the <TEST INFORMATION MENU MODE>. (To the display of the previously entered item 1.TST)
9. If there is no button input for 5 minutes, it automatically returns to the <TEST INFORMATION MENU MODE>.

| Item | Description | Display method |
|--------------------------------|---|----------------|
| Fan Motor | Fan motor component check menu display | |
| Water Adjustment Valve | Water adjustment valve component check menu display | |
| Dual Venturi | Dual Venturi component check menu display | |
| Pump ("A" models only) | Pump and flow sensor component check menu display | |
| Mixing valve ("S" models only) | Mixing valve component check menu display | |

| Component | Test Performed | Display |
|------------------------|---|---|
| Fan Motor | Gradually increase/ decrease the speed of the fan motor starting from 0 RPM to full speed and back down to 0 RPM. | The current APS value and the current rpm value is repeatedly displayed at intervals of 2 seconds |
| Water Adjustment Valve | Rotates the valve from its current position to fully open (56%), then fully closed (0%) and then back to the starting position while checking feedback. | Display of the valve close ratio % Display of "FEED" when detecting the feedback |

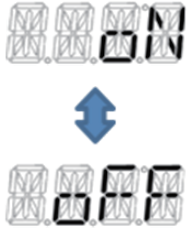
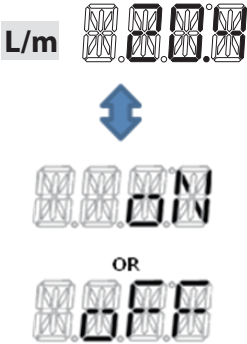
| Component | Test Performed | Display |
|--------------------------------|---|--|
| Dual Venturi | After starting the test, the Dual Venturi is turned ON, and whenever the [+], [-] button is pressed, the condition is toggled as On → Off or Off → On. | Whenever the [+], [-] button is pressed, the condition is toggled as On → Off or Off → On  |
| Pump ("A" models only) | Cycles the pump 10 sec On and 5 sec OFF five times. (Repeats five times for a total of 75 seconds) | The flow rate and ON/OFF are repeatedly displayed at intervals of 2 seconds L/m icon lights when the flow rate is displayed  |
| Mixing valve ("S" models only) | Rotates the valve from its current position to fully open (56%), then fully closed (0%) and then back to the starting position while checking feedback. | The display is the same as the water adjustment valve. |

* When selecting each test mode, the water heater performs an automatic test and then returns to the normal operation condition. (Manual operation required for a Dual Venturi Test)

4.7.18 Operation Condition Setting

1. While in <TEST INFORMATION MENU MODE>, press the [+]/[-] button and then press the [Info] button once when 2.OPR is displayed on the front panel.
2. Whenever the [+]/[-] button is pressed, it increases/decreases the operation condition and flashes at intervals of 500msec. If the condition is not changed for 3 seconds, it works at the displayed operation condition. (NORMAL operation condition > 1-stage MIN > 1-stage MAX > 2-stage MIN > 2-stage MAX > NORMAL operation condition)
3. If the [Reset] button is pressed once, then it returns to the <TEST INFORMATION MENU MODE>. (Displayed as the previously entered item 2.OPR)
4. If there is no button input for 3 hours, then it automatically returns to the <Normal operation mode>.

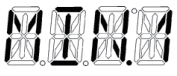
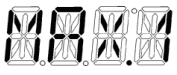
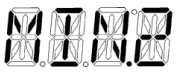
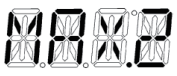
| Mode | Description | Display method |
|---------------------------------|--|---|
| Normal operation condition | Operated in a normal operation mode |  |
| 1-stage MIN operation condition | Operated in a 1-stage MIN operation mode |  |
| 1-stage MAX operation condition | Operated in a 1-stage MAX operation mode |  |
| 2-stage MIN operation condition | Operated in a 2-stage MIN operation mode |  |
| 2-stage MAX operation condition | Operated in a 2-stage MAX operation mode |  |

4.7.19 Mixing control mode (“S” models only)

NPE-S models have a control mode to limit the actuation of the mixing valve, which prevents malfunction of the mixing valve resulting from frequent operation.

To limit the mixing valve operation, follow these steps:

1. On the Front panel, press the Power button to turn off the heater.
2. Enter the R&D information menu by pressing the Up (+) button 3 times, the Down (-) button 3 times, and then the Up (+) button 4 more times.
3. In the R&D information menu, use the Up (+) or Down (-) buttons to move to 2.PAR (Parameter information mode), and then press the Info button.

| No. | Mode | Display method |
|-----|----------------------------|----------------|
| 1 | Technical information mode | |
| 2 | Parameter information mode | |

4. In the Parameter information mode, use the Up (+) or Down (-) buttons to select P.02 (Mixing control mode) and press the Info button to enter.

| No. | Mode | Display method |
|-----|-----------------------|----------------|
| 1 | Cascade protocol mode | |
| 2 | Mixing control mode | |
| 3 | Recirculation Type | |

5. In the Mixing control mode, use the Up (+) or Down (-) buttons to select an option and press the Info button to set the mode.

| Mode | Description | Display method |
|---------------------|---|----------------|
| Auto mode (Default) | <ol style="list-style-type: none"> 1. Switches to the Overshoot mode if DHW use exceeds 23,000 times in 3 months of operation. 2. Once any other mode is selected, Auto mode cannot be selected any more (factory reset will revert to the default setting). | |
| Normal mode | No limitations on mixing valve operation | |
| Overshoot mode | <ol style="list-style-type: none"> 1. Mixing valve is operated only when an overshooting occurs. 2. Operation begins when the DHW temperature exceeds the target temperature by more than -10 °C (14 °F). However, when the DHW temperature exceeds 55 °C (131 °F), the mixing valve operates to limit the temperature to 55 °C (131 °F). | |
| Off | Mixing valve control is not in use (fully closed at all times) | |

4.7.20 Initial setting of a cascade system

1. At the <Normal operation mode>, press the [Diagnostic] + [PLUS] button for over 5 seconds to set the current water heater as the MASTER unit and to enter <Cascade setup mode>.
2. Once in <Cascade setup mode>, it will be necessary to assign an ID number to each slave water heater in the system. Be sure that each slave unit has been connected using a Ready-Link cable.
3. On each slave water heater, press the [Diagnostic] + [MINUS] buttons for over 2 seconds to automatically receive an ID number from the MASTER water heater. The ID number will display on the front panel of each water heater.
4. The MASTER water heater will assign ID numbers sequentially in the order that the slave water heaters are configured (1-15).

- When all water heaters have been assigned an ID number, press the [Diagnostic] + [PLUS] buttons on the MASTER unit for over 5 seconds to complete the setup. The water heaters will return to <Normal operation mode> and the cascade system will be activated.
- If the cascade setting is not completed within 1 hour, the water heaters will revert to <Normal operation mode> and the cascade system will not be active.

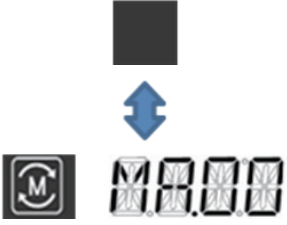
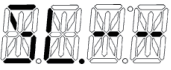
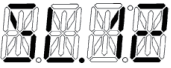
| Mode | Description | Display method |
|-----------------------------------|---|---|
| MASTER setting mode | Set as MASTER unit and assign ID numbers to slave units | MASTER icon flashing  |
| SLAVE ID initialization condition | When given an initialization command from the MASTER unit |  |
| SLAVE ID assignment condition | When given an ID from the MASTER unit | ex) ID 12  |

4.7.21 Cancellation of a cascade system

- If the [Diagnostic] + [reset] buttons are pressed for over 5 seconds while in <Normal operation mode> at the MASTER unit with CASCADE turned ON, then all units in the CASCADE SYSTEM are released and work individually.
- In order to reset the CASCADE SYSTEM after releasing it, repeat the CASCADE SYSTEM initialization procedure as described previously.
- If the [Diagnostic] + [reset] buttons are pressed for over 5 seconds while in <Normal operation mode> at the SLAVE unit where the CASCADE communication error(E.736) occurred with CASCADE turned ON, then the SLAVE unit is released from the CASCADE SYSTEM and works individually.

4.7.22 Cascade system – Master unit replacement



Configuration with NPE units only

In order to replace the Master water heater and the controller or change a slave unit into the MASTER unit, cancel the CASCADE SYSTEM and then repeat the CASCADE SYSTEM initialization procedure as described previously.

4.7.23 Cascade system – Slave unit addition

Configuration with NPE units only

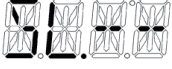
- In order to add an additional slave unit, connect a Ready-Link communication cable to the new unit and wait for the MASTER unit to automatically recognize the new unit. The slave unit will automatically enter <SLAVE addition mode> and display SL-- on the front panel.
- At the new slave unit, press the [Diagnostic] + [MINUS] button once to receive an ID number from the MASTER unit. The ID number will display for 5 seconds and then return to <Normal operation mode> linked into the CASCADE system.



| Mode | Description | Display method |
|-------------------------------|--|---|
| SLAVE addition mode | When connecting a new slave unit with a Ready-Link cable to the CASCADE system |  |
| SLAVE ID assignment condition | Given an ID from MASTER, and then the ID is displayed for 5 seconds | ex) ID 12  |

4.7.24 Cascade system – Panel [POWER] button function



1. Press the [POWER] button once at the front panel to turn ON/OFF each unit individually.
2. Press the [Diagnostic] + [POWER] button on the MASTER unit front panel for over 5 seconds to turn ON/OFF the whole CASCADE system.

4.7.25 Recirculation type Setting

1. In the Parameter information mode, use the Up (+) or Down (-) buttons to select P.03 (Recirculation type), and then press the Info button.

| No. | Mode | Display method |
|-----|---|---|
| 1 | Cascade protocol mode |  |
| 2 | Mixing control mode |  |
| 3 | Recirculation type (Main Controller version : after V1.5) |  |

2. In the Recirculation Type, use the Up (+) or Down (-) buttons to select an option and press the Info button(or no button input for 10 seconds) to set the mode.

| No. | Mode | Display method |
|-----|-----------------------------|---|
| 1 | Normal |  |
| 2 | Special mode for preheating |  |

3. If the [RESET] button pressed once, then it returns to the <PARAMETER INFORMATION MENU MODE>.

* If there is no button input for 5 minutes, then automatically returns to the <PARAMETER INFORMATION MENU MODE>.

4.8 Wiring Diagram

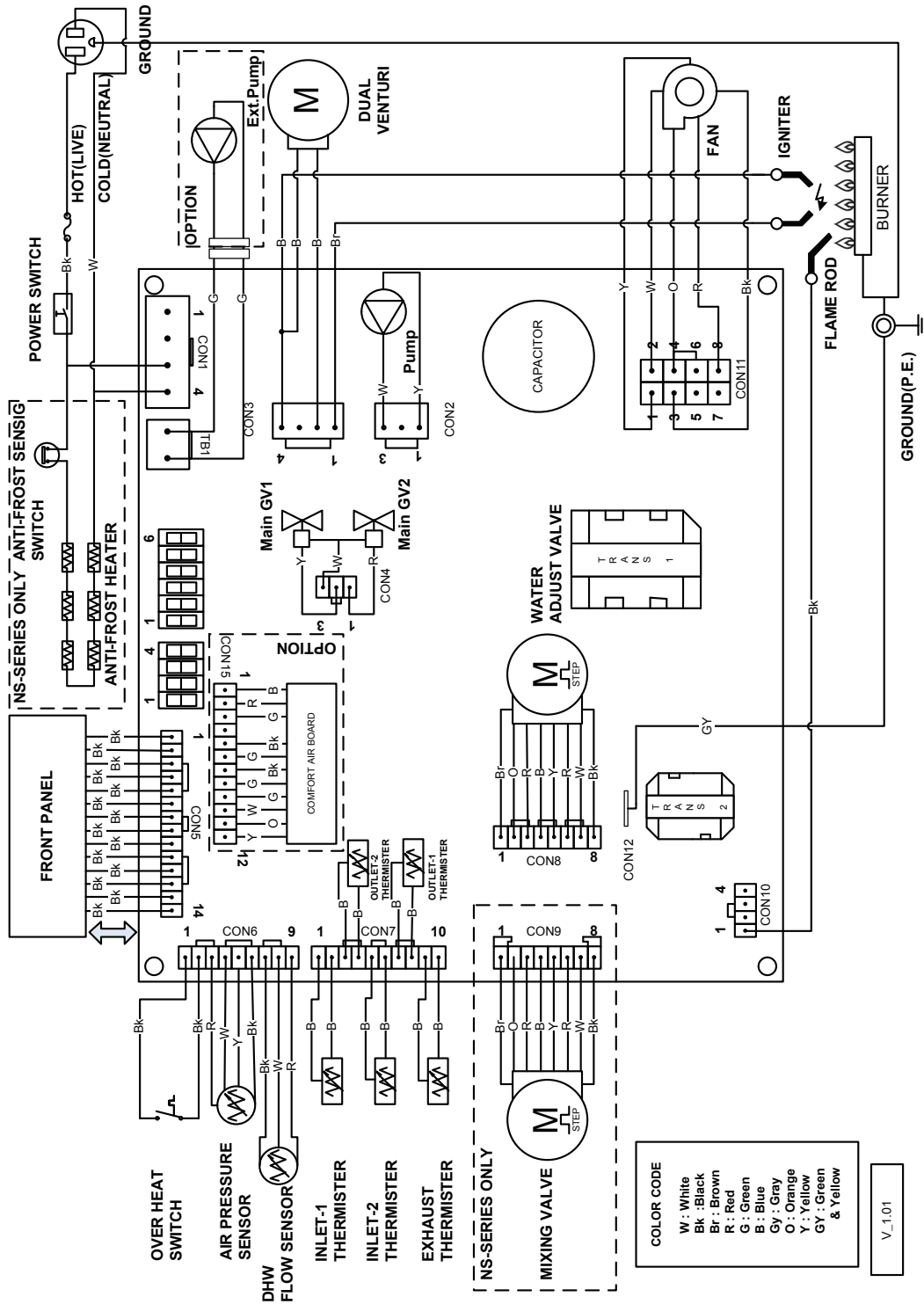

[NPE-24AWE/32AWE/24SWE/32SWE]

4.9 Ladder Diagram

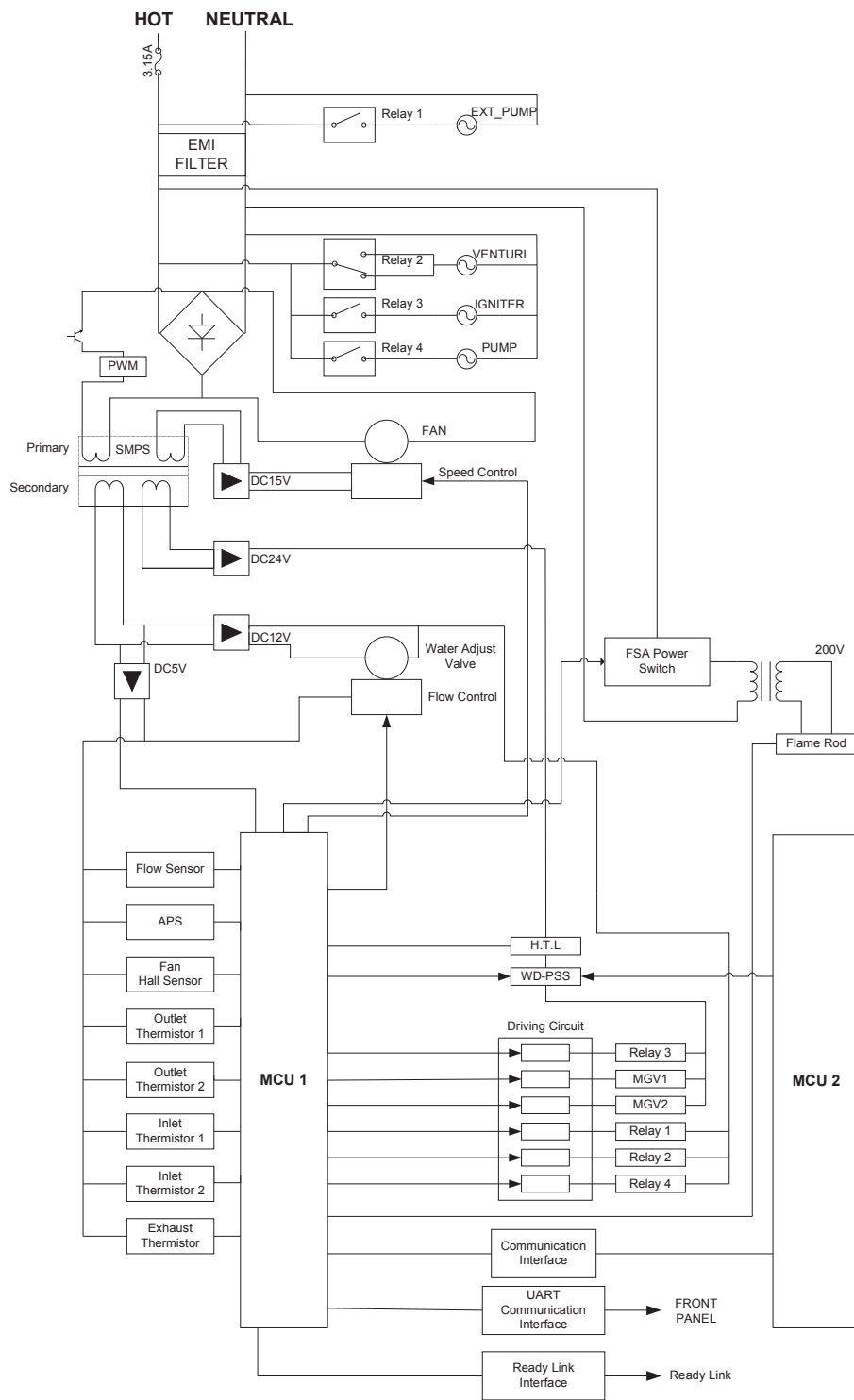

[NPE-24AWE/32AWE]

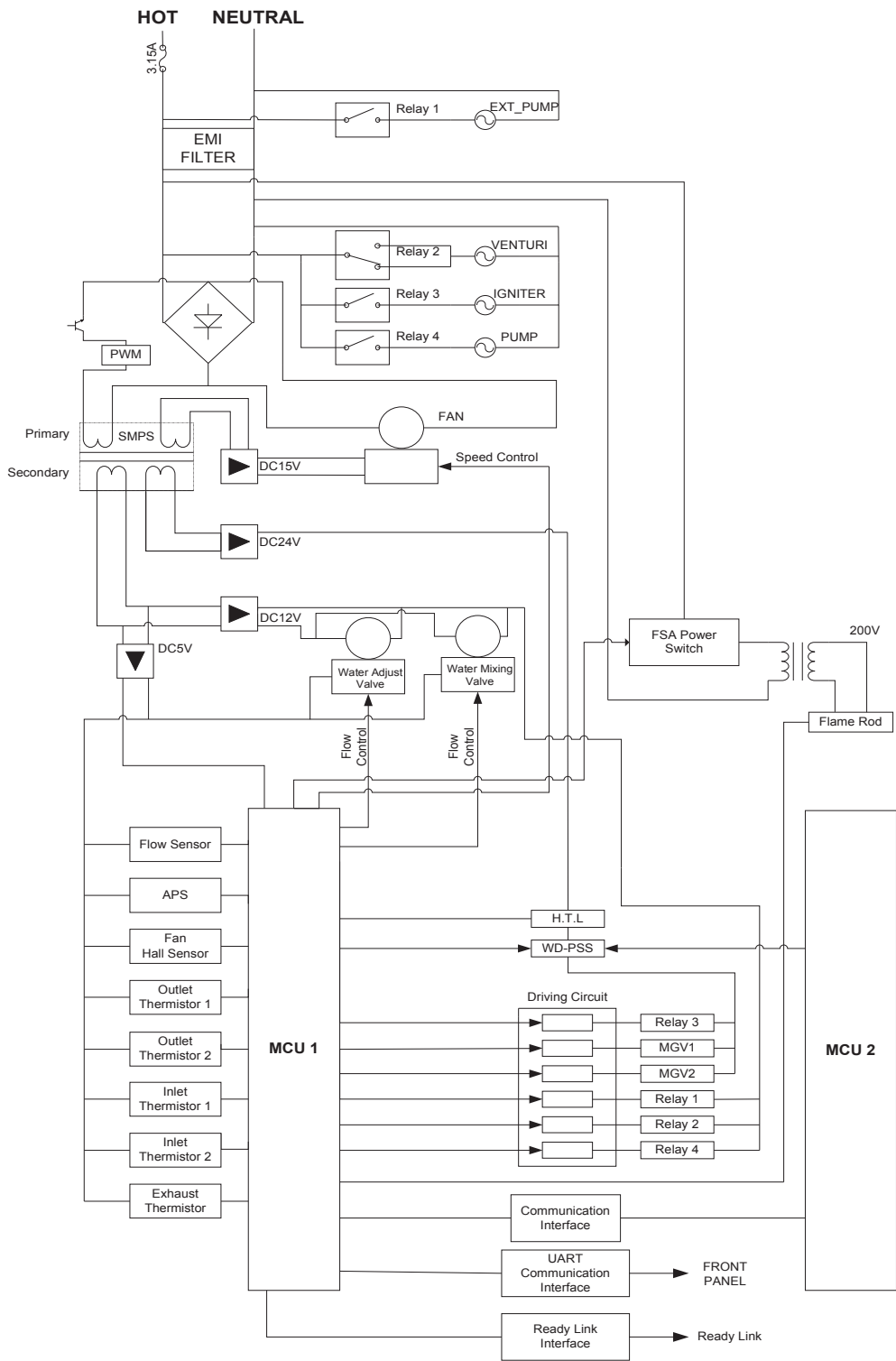

[NPE-24SWE/32SWE]

4.10 Electrical Diagnostic Points

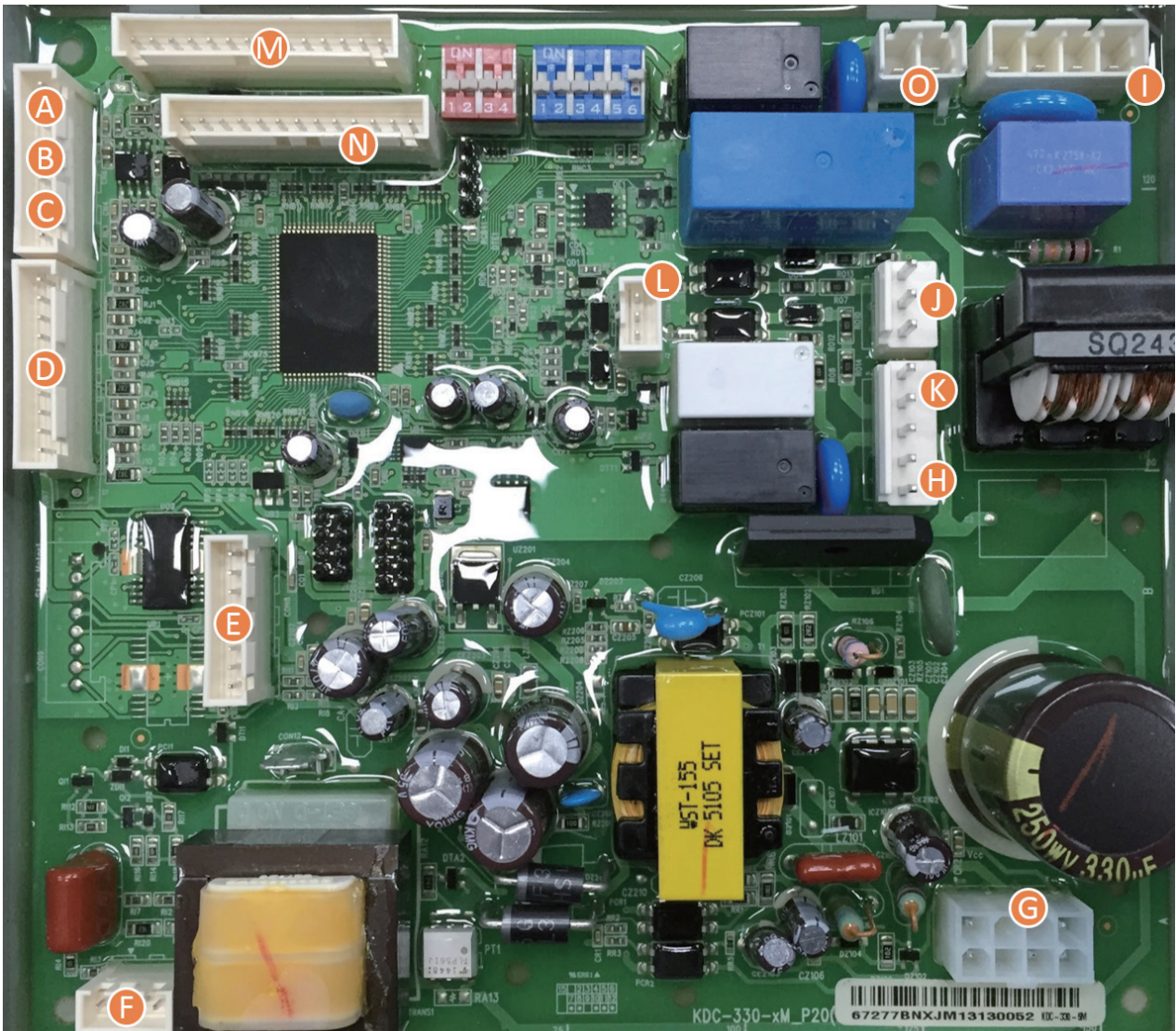

| Point | Function | Wire Color | Normal Value | Check |
|-------|-------------------------------|-------------|--------------|---|
| A | High Temperature Limit Switch | BLACK-BLACK | DC 0 V | Normally Shorted. Confirm RMS voltage. |
| B | APS | RED-BLACK | DC 5 V | Confirm steady voltage. |
| | | WHITE-BLACK | DC 0.3~4.5 V | Voltage changes according to the APS operation. |
| C | Flow Sensor | RED-BLACK | DC 12 V | Confirm steady voltage. |
| | | WHITE-BLACK | PULSE | Check Pulse. |
| D | Cold Water-1 | BLUE-BLUE | DC 0~5 V | Voltage changes according to temperature. |
| | Hot Water-2 | BLUE-BLUE | DC 0~5 V | Voltage changes according to temperature. |
| | Cold Water-1 | BLUE-BLUE | DC 0~5 V | Voltage changes according to temperature. |
| | Hot Water-2 | BLUE-BLUE | DC 0~5 V | Voltage changes according to temperature. |
| | Exhaust Sensor | BLUE-BLUE | DC 0~5 V | Voltage changes according to temperature. |

| Point | Function | Wire Color | Normal Value | Check |
|-------|-----------------------------|---------------|---------------------|--|
| E | Water Adjust / Mixing Valve | RED-BLACK | DC 12 V | Confirm steady voltage. |
| | | WHITE-BLACK | DC 0-5V | Voltage changes according to the Mixing Valve position. |
| | | BLUE-BROWN | | |
| | | ORANGE-YELLOW | PULSE | Check Pulse. |
| F | Flame Rod | BLACK | 0~10 uA | Measure the current when the burner is operating. |
| G | Fan Motor | BLACK-RED | DC 127~184 V | Confirm steady voltage. |
| | | BLACK-YELLOW | DC 15 V | Confirm steady voltage. |
| | | BLACK-ORANGE | DC 0~7.5 V | Voltage changes relative to fan operation. |
| | | BLACK-WHITE | 0 rpm~6500 rpm | Check PULSE. |
| H | Pump | YELLOW-WHITE | * ON : AC 198~253 V | Confirm voltage as operating. |
| | | | * OFF : 0V | |
| I | Power Input | WHITE-BLACK | AC 198~242 V | * Confirm appropriate power source. * Confirm the FUSE. * Confirm the circuit breaker. |
| | Ground Wire | GREEN-YELLOW | Ground Wire | Check for properly grounded wire. |
| J | Dual Venturi | BROWN-BLUE | * ON : AC 198~242 V | Confirm voltage relative to operation. |
| | | | * OFF : 0V | |
| K | Igniter | BLUE-BLUE | * ON : AC 97~138 V | Confirm voltage when the unit is igniting. |
| | | | * OFF : 0V | |
| L | Gas Valve | RED-YELLOW | DC 22~24 V | Confirm voltage as the Main Gas Valve 1 is operating. Resistance check: 103 Ω |
| | | WHITE-RED | DC 22~24 V | Confirm voltage as the Main Gas Valve 2 is operating. Resistance check: 103 Ω |
| M | Front Panel | BLACK | | |
| N | Comfort Air+ | BLACK | | |
| O | External Pump | BLACK | * ON : AC 198~242 V | Confirm voltage as operating. |
| | | | * OFF : 0V | |

4.11 Key Components Description

4.11.1 PCB

| Part | Check Point |
|-----------------------|---|
| Function | To control each component and also to check the overall performance of the unit. |
| Failure Event | Malfunctioning PCB. |
| Effects | A component may not operate within the unit and could produce an error code. In most cases of PCB failure, the whole unit will not operate until the problem is resolved. |
| Error Code | E515, E615 |
| Diagnostic | Visual inspection: Connection and/or breakage of wires and/or burn marks on the PCB. |
| Color/Number of wires | 25 (see page 51, 54) |

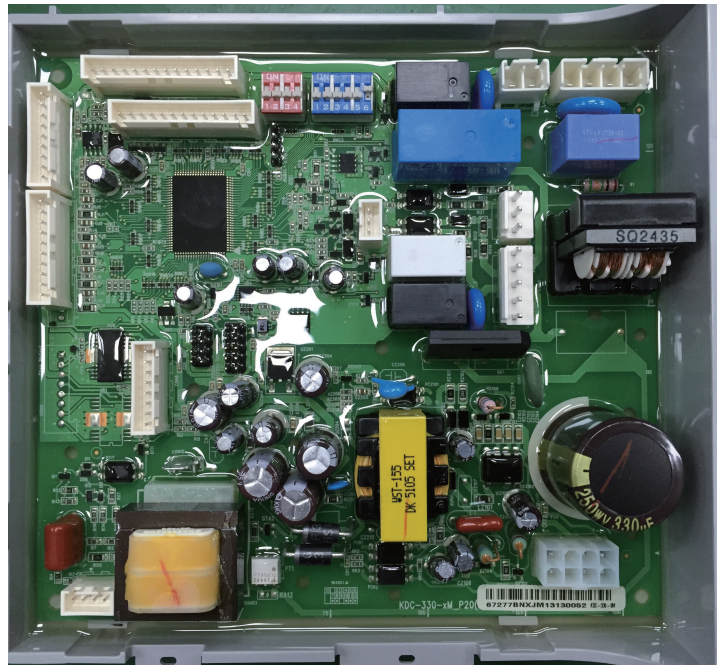

4.11.2 High Limit Switch

| Check Point | Check Point |
|--------------------------------|---|
| Function | <ol style="list-style-type: none"> 1. Overheat prevention switch. 2. If the unit detects extremely high temperatures, it will automatically trip and shut down the unit. 3. Excessively high water temperatures (more than 92 °C) in heat exchanger will activate the high limit switch. |
| Failure Event | Unable to detect excessively high water temperature if switch fails. |
| Effects | Unable to shut down the water heater if the water temperature from the heat exchanger exceeds 92 °C. |
| Error Code | E016, E046 |
| Diagnostic | <ol style="list-style-type: none"> 1. Visual inspection: Connection and/or breakage of wires. 2. Resistance check: Check range of resistance shown below. |
| Testing/Inspection Information | Resistance range : under 1.0 Ω |

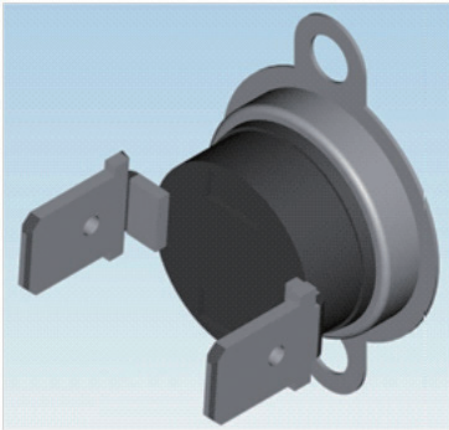

4.11.3 Anti Frozen Switch

| Check Point | Check Point |
|--------------------------------|---|
| Function | <ol style="list-style-type: none"> 1. Frozen prevention switch. 2. If the unit detects extremely Low temperatures, it will automatically operate the unit. 3. Excessively low water temperatures (under than 6 °C) will activate the anti frozen switch. |
| Failure Event | Unable to detect excessively low water temperature if switch fails. |
| Effects | Unable to operate the water heater even if the water temperature drops under 6 °C. |
| Diagnostic | <ol style="list-style-type: none"> 1. Visual inspection: Connection and/or breakage of wires. 2. Resistance check: Check range of resistance shown below. |
| Testing/Inspection Information | Resistance range (when operate): under 1.0 Ω |

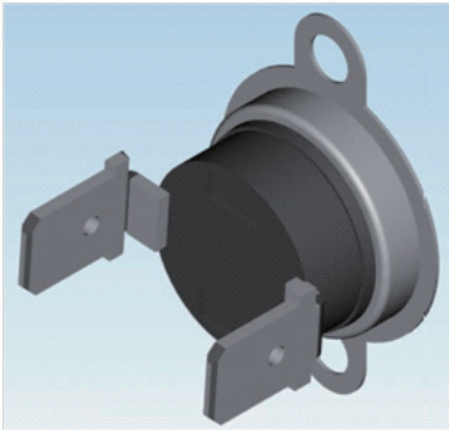

4.11.4 Anti Frozen Heater

| Check Point | Check Point |
|--------------------------------|---|
| Function | <ol style="list-style-type: none"> 1. Anti frozen heater. 2. If the anti frozen switch is turned on, heater will automatically operate. |
| Failure Event | Unable to operate anti frozen function. |
| Effects | Unable to operate the water heater even if the water temperature drops under 6 °C. |
| Diagnostic | <ol style="list-style-type: none"> 1. Visual inspection: Connection and/or breakage of wires. 2. Resistance check: Check range of resistance shown below. |
| Testing/Inspection Information | Resistance: 300 Ω (161.3 W during operation) |

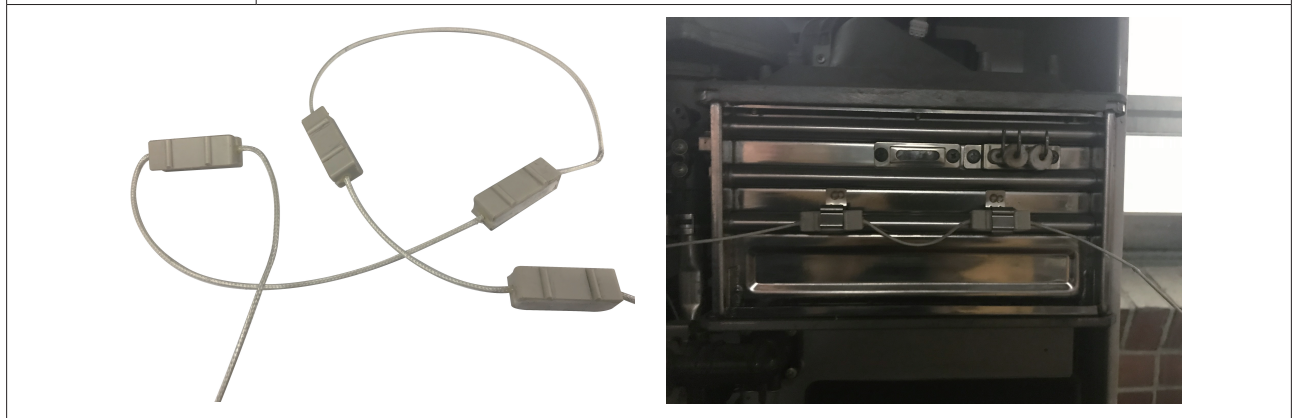

4.11.5 Thermistor

| Part | Check Point |
|--------------------------------|--|
| Function | Measure inlet, outlet, and internal heat exchanger temperatures in the water heater. |
| Failure Event | Unable to properly measure water temperature within the water heater. |
| Effects | <ol style="list-style-type: none"> 1. If any of the thermistors fail, an error code appears before starting operation. 2. If resistance values are off, the water heater will produce temperature fluctuations in hot water. |
| Error Code | E047, E407, E421, E432, E441 |
| Diagnostic | <ol style="list-style-type: none"> 1. Visual inspection: Connection and/or breakage of wires. 2. Check the resistance of the sensor (Stop operating and lower the temperature before checking). |
| Testing/Inspection Information | Resistance range : Please refer to the table below |



| Temp (°C) | Thermistor (kΩ) | Exhaust Limit Temperature Sensor (kΩ) |
|-----------|-----------------|---------------------------------------|
| 0~4 | 17.9~25.4 | 113.6~180.7 |
| 4~10 | 14.5~20.3 | 89.2~139.5 |
| 10~16 | 11.4~16.4 | 67.5~108.5 |
| 16~21 | 9.4~12.8 | 51.5~81.1 |
| 21~27 | 7.5~10.4 | 41.5~61.3 |
| 27~32 | 6~8.2 | 32.2~48.9 |
| 32~38 | 5.1~6.6 | 26.3~37.6 |
| 38~43 | 4.1~5.7 | 20.8~30.4 |

4.11.6 Fan Motor

| Part | Check Point |
|-----------------------|--|
| Function | To provide combustion air into the burner and to purge exhaust flue gas. To maintain the gas input with a long vent run, the fan operates with APS for ideal combustion. |
| Failure Event | <ol style="list-style-type: none"> 1. Fan speed failure: the fan RPM is around 0 RPM. 2. The fan assembly screw is loose and/or the fan is disassembled. 3. Disconnected or defective fan connection terminal assembly. |
| Effects | <ol style="list-style-type: none"> 1. Unstable combustion condition. 2. Unit vibrating and noise. 3. The water heater is not operating properly. |
| Error Code | E109, E110 |
| Diagnostic | <ol style="list-style-type: none"> 1. Visual inspection: check the fan connection wire and/or the fan mounting location. 2. Voltage check: Check range of voltage shown below. |
| Color/Number of wires | <ul style="list-style-type: none"> • Black-Red: DC 127~184 V • Black-Yellow: DC 15 V • Black-Orange: DC 0~7.5 V • Black-White: 0 ~ 7,000 RPM |

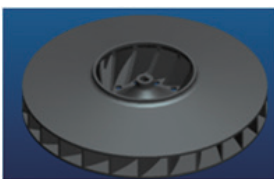
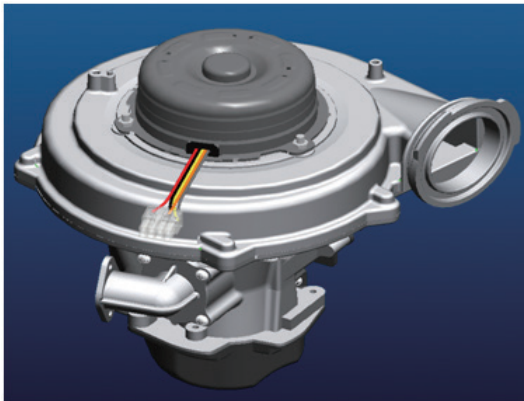

4.11.7 Flame Rod Assembly

| Part | Check Point |
|--------------------------------|---|
| Function | To ignite gas by repeatedly discharging a high voltage spark to the main burner until gas ignites. |
| Failure Event | <ol style="list-style-type: none"> 1. Unable to ignite during the ignition process. 2. Produces multiple unsuccessful attempts to ignite. |
| Effects | <ol style="list-style-type: none"> 1. The unit cannot ignite during the ignition process and "E003" or "E004" error codes will display. 2. Durability of the igniter wears down |
| Error Code | E003, E004, E012 |
| Diagnostic | Visual inspection: Connection and/or breakage of wires. |
| Testing/Inspection Information | BLACK: 0~10 uA |

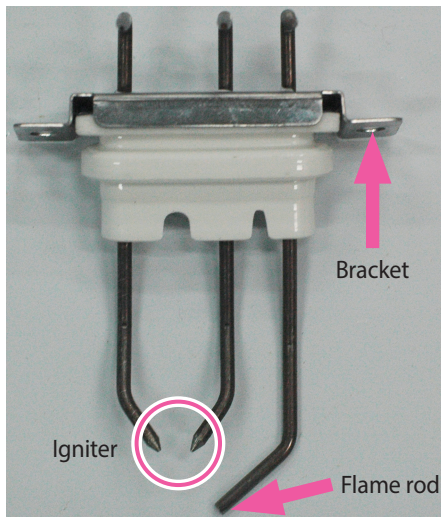

Gap distance : 3.5~4.5mm (1/8")

4.11.8 Ignition Transformer

| Part | Check Point |
|--------------------------------|--|
| Function | To ignite gas by repeatedly discharging a high voltage spark to the main burner until gas ignites. |
| Failure Event | <ol style="list-style-type: none"> 1. Unable to ignite during the ignition process. 2. Produces multiple unsuccessful attempts to ignite. |
| Effects | <ol style="list-style-type: none"> 1. The unit cannot ignite during the ignition process and "E003" or "E004" error codes will display. 2. Durability of the igniter wears down. |
| Error Code | E003, E004 |
| Diagnostic | <ol style="list-style-type: none"> 1. Visual inspection: Connection and/or breakage of wires. 2. Voltage check: Check range of voltage shown below. |
| Testing/Inspection Information | Blue <ul style="list-style-type: none"> • On : AC 198~242 V • Off : 0V |

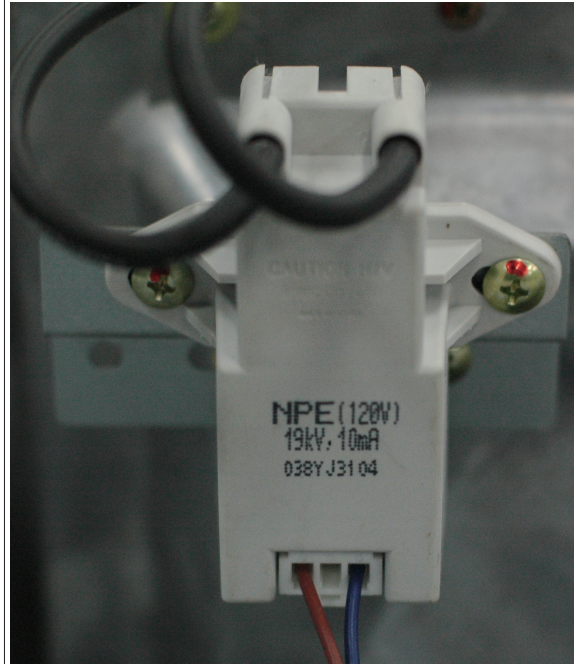
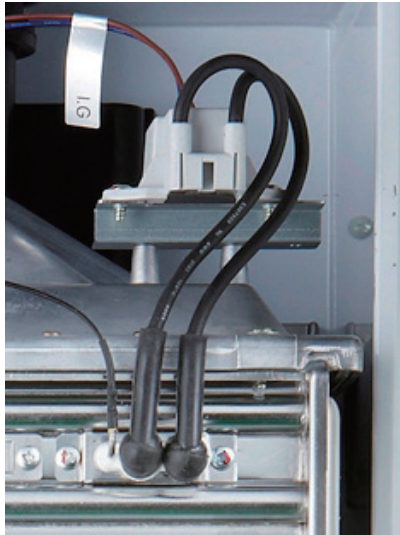

| Input Voltage | Output Voltage | Output Current |
|-----------------|----------------|----------------|
| 220 V, 50/60 Hz | 19 kV ±2 kV | 7 mA ±2 mA |

4.11.9 APS

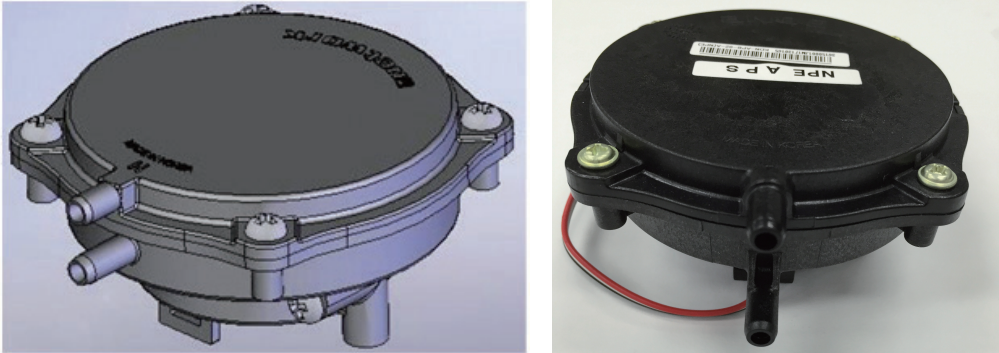
| Part | Check Point |
|--|---|
| Function | Detecting the air pressure entering the burner system. |
| Failure Event | <ol style="list-style-type: none"> 1. Combustion noise occurs. 2. Imperfect and/or abnormal flame occurs. 3. Occurs when APS does not detect proper voltage. |
| Effects | <ol style="list-style-type: none"> 1. The water heater is not operating. 2. Produces excessive carbon monoxide emissions. |
| Error Code | E110 |
| Diagnostic | <ol style="list-style-type: none"> 1. Visual inspection: Connection and/or breakage of wires. 2. Voltage check: Check range of voltage shown below. 3. Check the exhaust duct for obstruction or blockages. 4. Check the condensate trap and drain piping for obstruction or blockages. 5. Check for decreased hot water output. |
| Color/Number of wires | <ul style="list-style-type: none"> • RED-BLACK: DC 5 V • WHITE-BLACK: DC 0.3~4.5 V |
|  | |

4.11.10 Main Gas Valve

| Part | Check Point |
|-----------------------|--|
| Function | <ol style="list-style-type: none"> To control the amount of gas supplied to the burner based on fan speed. When the unit experiences abnormal combustion, it shuts off the gas valve automatically and prevents unsafe situations. |
| Failure Event | Unable to open/close |
| Effects | <ol style="list-style-type: none"> No flames. No operation of the unit. |
| Error Code | E003, E012 |
| Diagnostic | <ol style="list-style-type: none"> Visual inspection: Connection and/or breakage of wires. Voltage check: Check range of voltage shown below. Resistance check: Check resistance shown below. |
| Color/Number of wires | <ul style="list-style-type: none"> EV1 (RED-YELLOW): DC 22~24 V (103 Ω) EV2 (WHITE-RED): DC 22~24 V (222 Ω) |

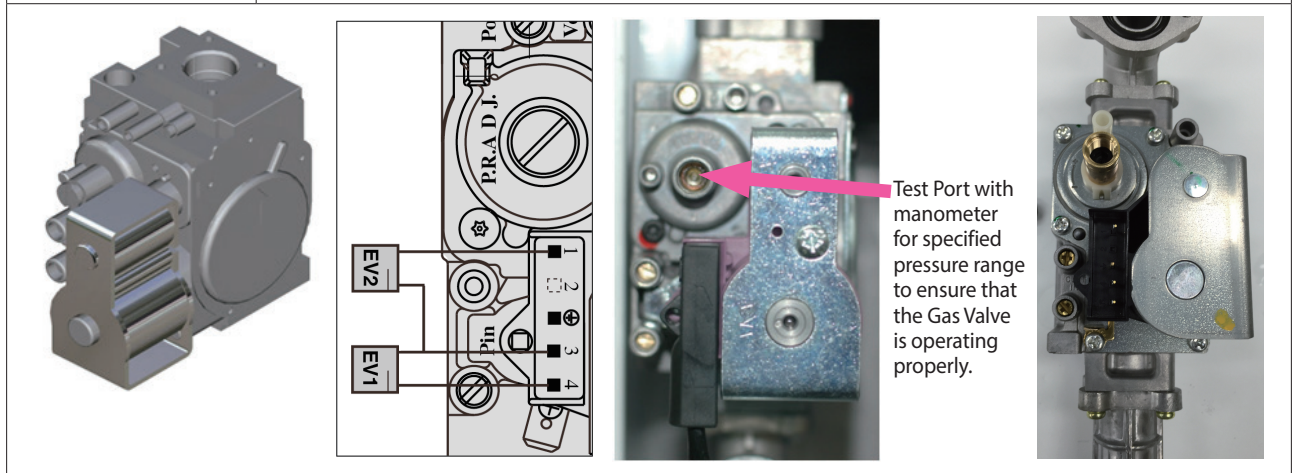

4.11.11 Burner

| Part | Check Point |
|-----------------------|---|
| Function | <ol style="list-style-type: none"> 1. Pre-Mix system reduces emissions and increase efficiency. 2. The burner facilitates the air/gas mixture necessary to produce the proper heat during combustion. |
| Failure Event | <ol style="list-style-type: none"> 1. Unable to initialize/sustain combustion. 2. Dust or soot deposit on the burner surface 3. Possible gas leakage from burners. |
| Effects | <ol style="list-style-type: none"> 1. Abnormal combustion. 2. Unstable flame conditions and/or flame loss. 3. Ignition failure. |
| Error Code | E003, E004, E012 |
| Diagnostic | Visual inspection: Excessive deposits on the burner surface and/or unstable flame conditions during operation. |
| Color/Number of wires | N/A |

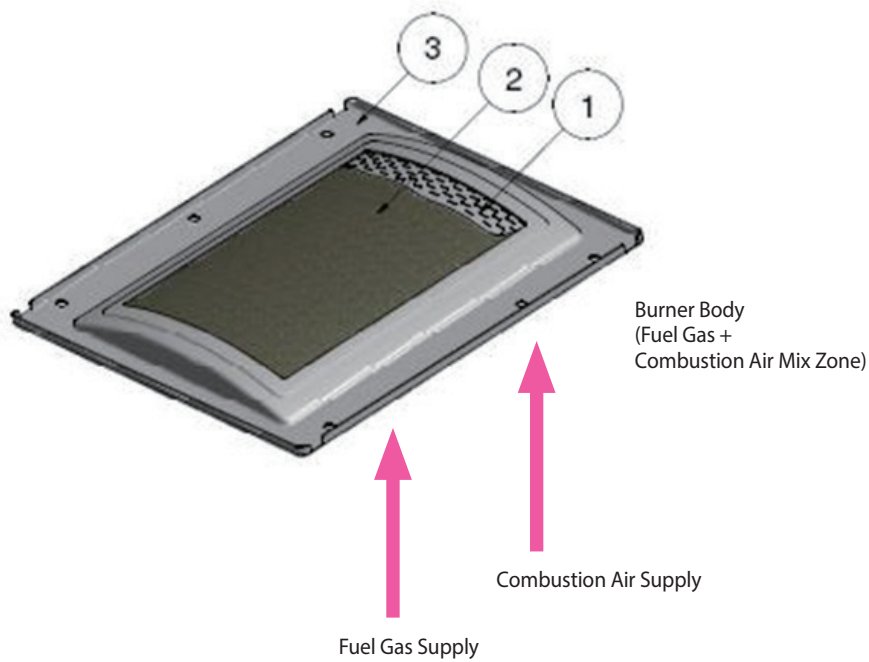

4.11.12 Water Adjustment Valve

| Part | Check Point |
|-----------------------|--|
| Function | To control the water flow to maintain steady hot water temperatures. |
| Failure Event | The valve cannot modulate or open/close in CASCADE mode. |
| Effects | <ol style="list-style-type: none"> 1. Water Adjustment Valve is not operating properly. 2. Abnormal flow detected during normal operation. "E434" displayed. 3. Temperature fluctuations at the hot water outlet. |
| Error Code | E434 |
| Diagnostic | <ol style="list-style-type: none"> 1. Visual inspection: Connection and/or breakage of wires. Clean the Domestic cold water inlet filter. 2. Voltage check: Check range of voltage shown below. |
| Color/Number of wires | <ul style="list-style-type: none"> • RED-BLACK: DC 12 V • WHITE-BLACK Start position: DC 0 V Any open position: DC 5 V • BLUE-BROWN: PULSE • ORANGE-YELLOW |

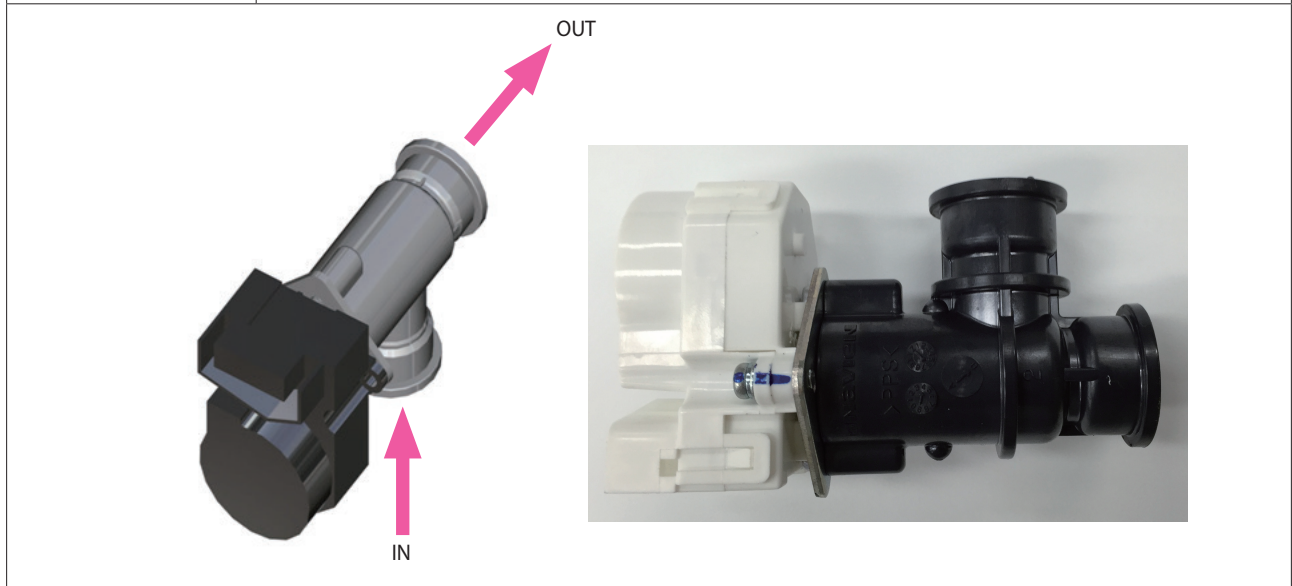

4.11.13 Flow Sensor

| Part | Check Point |
|---------------|--|
| Function | To detect water flow in GPM (Gallons Per Minute) for steady hot water temperatures. |
| Failure Event | <ol style="list-style-type: none"> 1. Unable to detect or measure water flow rate. 2. Damage to and/or water leakage from the water flow sensor. |
| Effects | Ignition sequence does not start. |
| Error Code | E439 |
| Diagnostic | <ol style="list-style-type: none"> 1. Visual inspection: Connection and/or breakage of wires. 2. Visual Inspection: Check for damage and/or scale formation on sensor. |

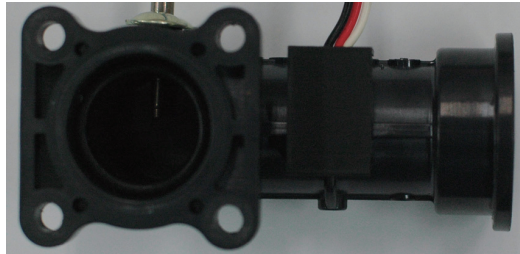
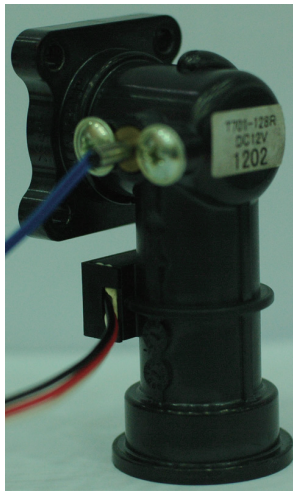

4.11.14 Primary Heat Exchanger

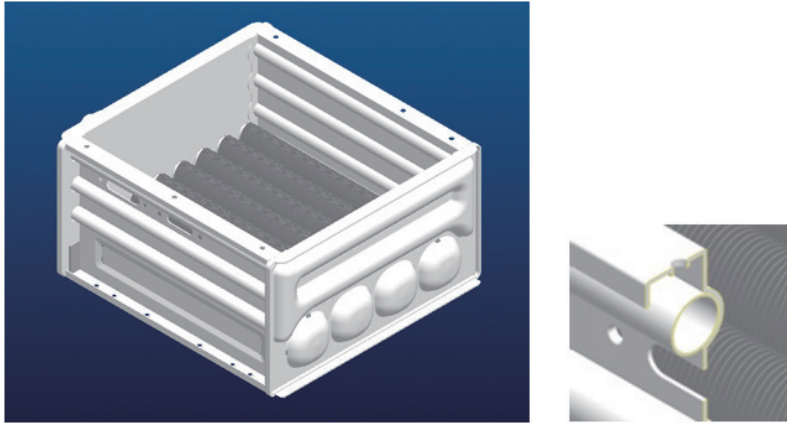
| Part | Check Point |
|---|---|
| Function | <ol style="list-style-type: none"> 1. Main part for heat transfer from the burner. 2. There are multiple paths of water pipes on the heat exchanger surface as well as inside the combustion chamber which minimizes the heat loss. |
| Failure Event | <ol style="list-style-type: none"> 1. Water and/or exhaust gas leakage through a crack. 2. Improper heat transfer can cause the water in the heat exchanger to boil due to possible scale formation. |
| Effects | <ol style="list-style-type: none"> 1. Exhaust gas leakage. 2. Excessive heating of the water that produces boiling noises. |
| Error Code | E016, E030, E047 |
| Diagnostic | <ol style="list-style-type: none"> 1. Visual inspection: Check if there is a crack on the surface of heat exchanger. 2. Sound inspection: Check if boiling occurs inside the unit. |
| Color/Number of wires | N/A |
|  <p>The image shows a 3D CAD model of a primary heat exchanger. The main view on the left is a perspective view of a rectangular metal housing containing several parallel tubes. The front panel features four circular ports. A close-up view on the right shows a cross-section of the housing and a tube, highlighting the internal structure and a potential leak point at a joint.</p> | |

4.11.15 Secondary Heat Exchanger

| Part | Check Point |
|-----------------------|---|
| Function | <ol style="list-style-type: none"> 1. Main part for heat transfer from the burner. 2. There are multiple paths of water pipes on the heat exchanger as well as inside the combustion chamber which minimizes heat loss. |
| Failure Event | <ol style="list-style-type: none"> 1. Water and/or exhaust gas leakage through a crack. 2. Improper heat transfer can cause the water in heat exchanger to boil. |
| Effects | <ol style="list-style-type: none"> 1. Exhaust gas leakage. 2. Excessive heating of the water that produces boiling noises. |
| Error Code | E016, E030, E047 |
| Diagnostic | <ol style="list-style-type: none"> 1. Visual inspection: Check if there is a crack on the surface of heat exchanger. 2. Sound inspection: Check if boiling occurs. |
| Color/Number of wires | N/A |

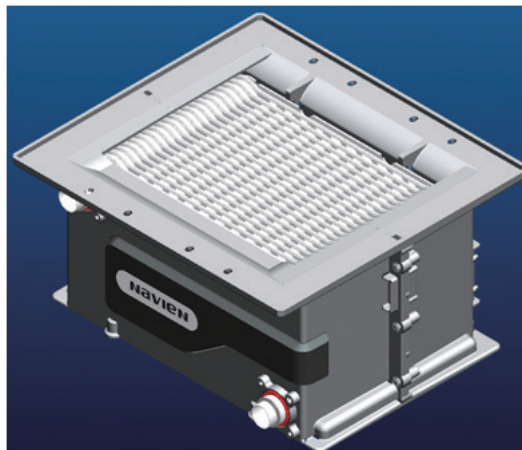

4.11.16 Buffer Tank ("A" models only)

| Part | Check Point |
|-----------------------|--|
| Function | To provide hot water at a steady temperature and to operate without a minimum flow rate with the use of the internal circulation pump. |
| Failure Event | Cracking and/or water leakage due to wear. |
| Effects | Temperature fluctuations in the hot water outlet and/or leaking. |
| Error Code | N/A |
| Diagnostic | Visual inspection : Check the mini buffer tank for any cracks. |
| Color/Number of wires | N/A |



4.11.17 Circulation Pump (“A” models only)

| Part | Check Point |
|-----------------------|--|
| Function | <ol style="list-style-type: none"> 1. Pump operates when using internal or external hot water circulation. 2. Internal circulation will minimize the effect of temperature fluctuations and external circulation delivers hot water to fixtures quickly resulting in water conservation. |
| Failure Event | Unable to detect or measure water flow rate when the pump is called to operate. |
| Effects | <ol style="list-style-type: none"> 1. The water heater freezes. 2. Temperature fluctuations when the water heater is set to internal recirculation. 3. Hot water is not quickly available at fixtures when the water heater is set to external recirculation. |
| Error Code | E438 |
| Diagnostic | <ol style="list-style-type: none"> 1. Visual inspection: Check the circulation pump connection wire. * Check for blocked/clogged water filter. 2. Voltage check: Check range of voltage shown below. |
| Color/Number of wires | YELLOW-WHITE <ul style="list-style-type: none"> • ON : AC 198~253 V • OFF : 0V |

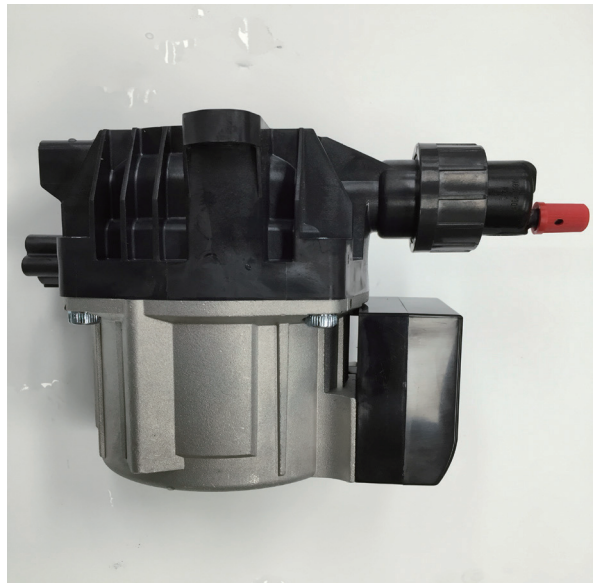

5. Troubleshooting

5.1 Error Code List

| Error Code | Sub Code | Function | Self-diagnostic/Action |
|------------|----------|--|---|
| E003 | 0 | Ignition failure | <ul style="list-style-type: none"> • Check to see if the main gas supply valve is open. • Verify that gas pressure is within operating range. • Check gas system and orifice. • Check Dual Venturi for proper operation. • Check for proper dipswitch settings (see page 21). • Tighten the ground connection screws on heat exchanger. |
| E004 | 0 | FALSE flame detection | <ul style="list-style-type: none"> • Ensure ground wire is connected. • Check the igniter for spark. |
| E012 | 0 | Flame loss | <ul style="list-style-type: none"> • Check the main gas line (Is the valve open?). • Verify gas pressure is within operating range. • Check gas meter for proper BTU capacity. • Check flame rod and verify [J] value in DIAGNOSTIC mode. • Check intake air filter. • Check ground wire. • Check power supply. • Tighten the ground connection screws on heat exchanger. |
| E016 | 0 | Overheating of heat exchanger | <ul style="list-style-type: none"> • Clean the inlet water filter. • Check High Limit Switch. • Check for proper dipswitch settings (see page 21) • Check the water adjustment valve. • Check the heat exchanger; a flush may be necessary. • Check pump operation (for A models only). • Turn OFF the system for at least 30 minutes then restart. |
| E030 | 0 | Exhaust Overheat: exhaust limit sensor shuts down the unit when the flue temperature exceeds 110 °C (230 °F) for more than 10 seconds. | <ul style="list-style-type: none"> • Turn OFF the system for at least 30 minutes then restart. • Clean the inlet water filter. • Check exhaust thermistor and verify [K] value in DIAGNOSTIC mode. • Check for proper dipswitch settings. • Check the water adjustment valve. • Check the heat exchanger; a flush may be necessary. |
| E047 | 1 | Abnormal exhaust thermistor (open) | <ul style="list-style-type: none"> • Check exhaust thermistor connection. |
| | 2 | Abnormal exhaust thermistor (short) | <ul style="list-style-type: none"> • Check for proper connection to the PCB. |
| E060 | 1 | Abnormal Dual Venturi Limit Switch operation (ON) | <ul style="list-style-type: none"> • Check the Dual Venturi connection. |
| | 2 | Abnormal Dual Venturi Limit Switch operation (Close OFF) | <ul style="list-style-type: none"> • Test Dual Venturi for proper operation using TEST mode. |
| | 3 | Abnormal Dual Venturi Limit Switch operation (Open ON) | <ul style="list-style-type: none"> • Check gas orifice for obstructions. |
| E109 | 0 | Abnormal fan motor activity | <ul style="list-style-type: none"> • Check and clean the intake air filter. • Verify proper voltage and wire connection. • Check and clean the fan motor. |

| Error Code | Sub Code | Function | Self-diagnostic/Action |
|------------|----------|--|--|
| E110 | 1 | Exhaust blockage (checking the FAN) | <ul style="list-style-type: none"> Check the intake/exhaust/condensate drain pipe for obstructions.(ice, snow, wildlife, etc) |
| | 2 | Exhaust blockage (Using hot water) | <ul style="list-style-type: none"> Check and clean the intake air filter. |
| | 3 | Exhaust blockage (using space heating) | <ul style="list-style-type: none"> As a temporarily solution for troubleshooting purposes, restart the unit and/or remove the front cover. |
| E407 | 1 | Abnormal Hot water outlet thermistor (Open) | <ul style="list-style-type: none"> Check the thermistor. |
| | 2 | Abnormal Hot water outlet thermistor (Short) | <ul style="list-style-type: none"> Replace the thermistor. |
| E421 | 1 | Abnormal Cold water inlet thermistor (Open) | <ul style="list-style-type: none"> Check the thermistor. |
| | 2 | Abnormal Cold water inlet thermistor (Short) | <ul style="list-style-type: none"> Verify [C] value in DIAGNOSTIC mode. Replace the thermistor. |
| E432 | 1 | Abnormal Cold water inlet2: thermistor (Open) | <ul style="list-style-type: none"> Check the thermistor. |
| | 2 | Abnormal Cold water inlet2: thermistor (Short) | <ul style="list-style-type: none"> Check thermistor voltage and resistance values. Replace the thermistor. |
| E434 | 1 | Abnormal water adjustment valve. (Open) | <ul style="list-style-type: none"> Check the water adjustment valve. |
| | 2 | Abnormal water adjustment valve. (Close) | |
| E438 | 0 | Abnormal circulation pump. ("A" models only) | <ul style="list-style-type: none"> Check the circulation pump. Check water filter for blockage. Check the flow sensor. Check the cold water main line. Set to Internal Recirculation mode and verify flow rate. |
| E439 | 0 | Abnormal flow sensor | <ul style="list-style-type: none"> Check the flow sensor. |
| E441 | 1 | Abnormal Hot water inlet2: thermistor(Open) | <ul style="list-style-type: none"> Check the thermistor. |
| | 2 | Abnormal Hot water inlet2: thermistor(Short) | <ul style="list-style-type: none"> Replace the thermistor. |
| E445 | 1 | Abnormal mixing valve(Open) | <ul style="list-style-type: none"> Check the mixing valve. |
| | 2 | Abnormal mixing valve(Close) | |
| E515 | 1~7 | Abnormal communicatin between PCB and Ignitor. | <ul style="list-style-type: none"> Check the PCB. |
| | 8 | Abnormal communication between PCB and Ignitor | <ul style="list-style-type: none"> Check the PCB connection. Check the Ignitor. |
| | 9 | Abnormal communication between PCB and FAN | <ul style="list-style-type: none"> Check the PCB connection Check the Fan |
| | 10 | Abnormal monitoring device of PCB | <ul style="list-style-type: none"> Check the PCB connection. Check the Dual Venturi. |
| | 11~12 | Abnormal communication between PCB and Dual Venturi | <ul style="list-style-type: none"> Check the PCB connection Check the Dual Venturi |
| E517 | 0 | Abnormal dip switch setting | <ul style="list-style-type: none"> Check the dip switches on the front panel and PCB. |
| E593 | 1 | Abnormal panel key | <ul style="list-style-type: none"> Check the Panel. |
| E594 | 0 | Abnormal input data from High limit switch of Heat exchanger | <ul style="list-style-type: none"> Check the PCB. |

| Error Code | Sub Code | Function | Self-diagnostic/Action |
|------------|----------|---|--|
| E594 | 1 | Abnormal input data from exhaust sensor | <ul style="list-style-type: none"> • Check the exhaust sensor wiring connection. • Check the exhaust sensor. |
| | 2 | Abnormal input data from flame rod | <ul style="list-style-type: none"> • Check the flame rod wiring connection. • Check the flame rod. |
| | 3~14 | Abnormal memory of PCB | <ul style="list-style-type: none"> • Check the PCB. |
| | 15 | Below the range of input data from Pressure sensor | <ul style="list-style-type: none"> • Check the Pressure sensor wiring connection. • Check the output voltage of pressure sensor. |
| | 16 | Over the range of input data from Pressure sensor | |
| E615 | 0 | Abnormal input data from High limit switch of Heat exchanger | <ul style="list-style-type: none"> • Check the PCB. |
| | 1 | Abnormal input data from exhaust sensor | <ul style="list-style-type: none"> • Check the exhaust sensor wiring connection. • Check the exhaust sensor. |
| | 2 | Abnormal input data from flame rod | <ul style="list-style-type: none"> • Check the flame rod wiring connection. • Check the flame rod. |
| | 3~14 | Abnormal memory of PCB | <ul style="list-style-type: none"> • Check the PCB. |
| | 15 | Below the range of input data from Pressure sensor | <ul style="list-style-type: none"> • Check the Pressure sensor wiring connection. • Check the output voltage of pressure sensor. |
| | 16 | Over the range of input data from Pressure sensor | |
| E736 | 0 | Abnormal cascade communication | <ul style="list-style-type: none"> • Check the Ready-Link cable. • Check the cascade settings. • Check PCB version for compatibility. |
| E740 | 1 | Abnormal outdoor temperature sensor (Open) (appears only when the outdoor reset curve is enabled). | <ul style="list-style-type: none"> • 1. Ensure that the outdoor reset curve is configured properly. • 2. Check the outdoor temperature sensor wiring connection. |
| | 2 | Abnormal outdoor temperature sensor (Short) (appears only when the outdoor reset curve is enabled). | |
| E760 | 0 | Flushing/service alarm | <ul style="list-style-type: none"> • A heat exchanger flush is necessary. |
| E782 | 0 | Abnormal Main-Panel communication | <ul style="list-style-type: none"> • Check the PCB. |
| E785 | 0 | Abnormal Flow Switch Operation | <ul style="list-style-type: none"> • Check the Cold Water line. • Check the Flow Switch connection. |

If any of the above solutions do not resolve the problem with the Water Heater, contact Navien's Technical department at 1-800-519-8794.

There will be error codes displayed on the front panel and recorded on the PCB board (within the unit) of any problems or failures that occur with the Water Heater.



IMPORTANT

To reset the Water Heater, either press the [Reset] button on the front panel or disconnect, then reconnect electrical power to the water heater.

5.1.1 003Error

Error occurrence conditions and check items

| Error | Description |
|--------------------------|--|
| E003 Ignition failure | In the case of an ignition failure, the water heater will attempt ignition 10 times. If no flame is detected, the system displays the error message E003 (manually cleared) on the remote controller. |
| Check items | <ol style="list-style-type: none"> 1. Check if the gas supply valve is open and for proper supply pressure. 2. Check the electrode gap, electricity discharge, or deformation of the flame rod. 3. Check the operation of the ignition transformer (ignition state, input power (AC 102~132 V) 4. Check the operation of the gas control valve (DC 22~24 V, coil short circuit, solenoid valve). 5. Check the flame rod, wiring and grounding. 6. Check if the air pressure hose is broken or clogged. 7. Check if the air pressure sensor works properly. 8. Check the PCB DIP switch settings. 9. Adjust the offset pressure (see page 28). 10. Check the gas orifice plate for the proper gas type. 11. Check the flue and air supply for any collected water (for vertical vent installations). 12. Tighten the ground connection screws on heat exchanger. 13. If the issues continue despite checking the items above, replace the PCB. |

Scenario1

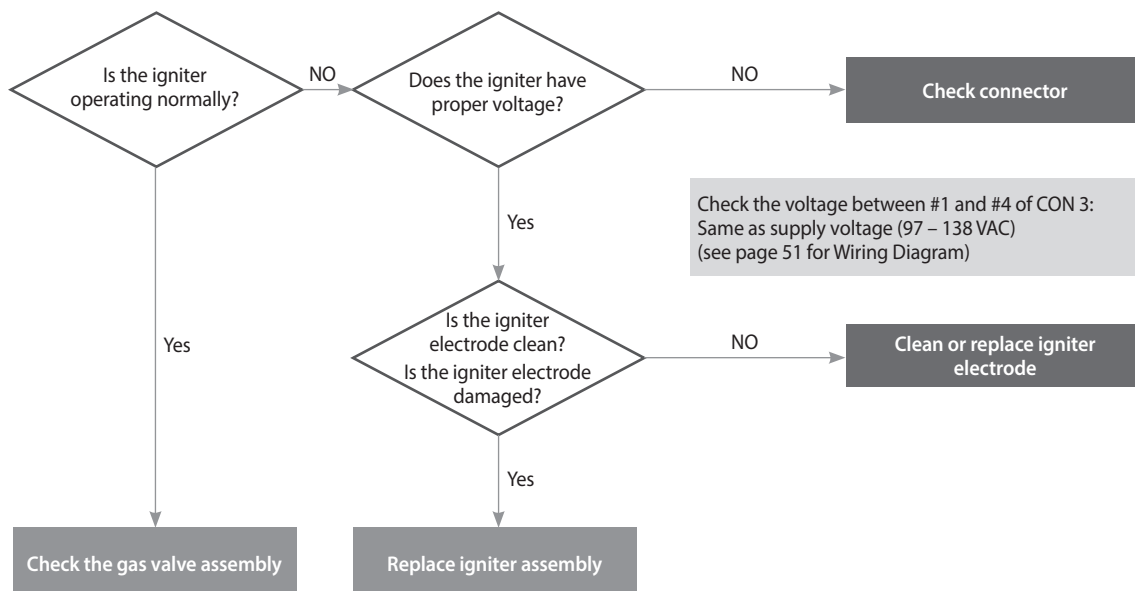

Scenario2

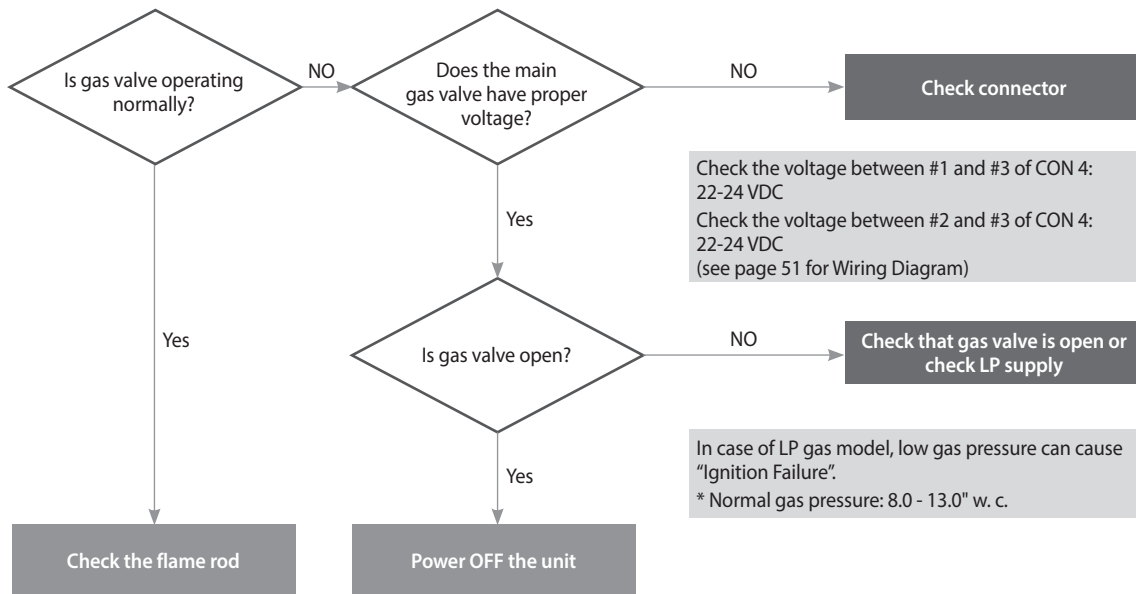

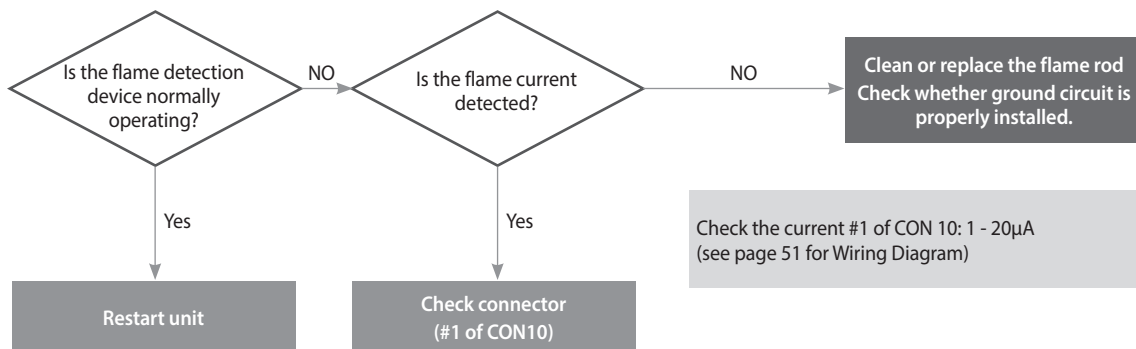

Scenario3

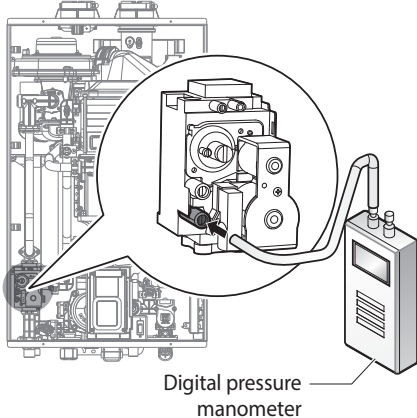
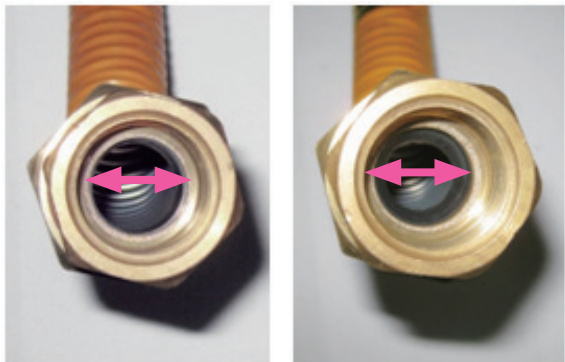

Check method

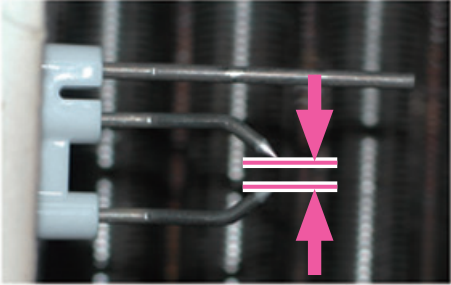
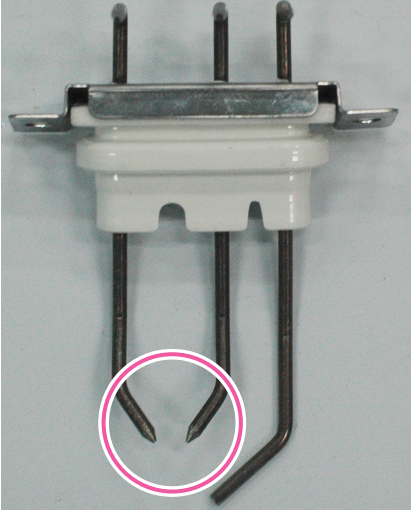
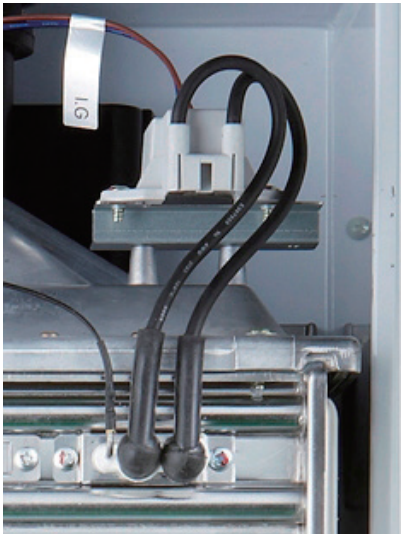
| Failure mode | Cause | Check method |
|------------------|---|---|
| | Gas supply error | <ol style="list-style-type: none"> 1. Check if the main gas valve is open. 2. Check the gas supply pressure. <ul style="list-style-type: none"> • NG: 3.5" - 10.5" W.C, LP: 8" - 13" W.C • LP pressure drop occurs frequently in the winter. 3. Check the flexible pipe diameter for compatibility with the water heater. 4. While the static pressure is normal, the use of another gas appliance may cause a possible drop in gas pressure to the unit. Therefore, it is required to check the dynamic pressure. <ul style="list-style-type: none"> • Static pressure: Gas pressure during stand by. • Dynamic pressure: Gas pressure at max combustion. (2nd stage MAX combustion setting: DIP S/W 1-1 ON) 5. If a CSST connector has been used, check to ensure that it is not been overtightened resulting in the seal obstructing gas flow. 6. Check the meter class (Example) <ul style="list-style-type: none"> • Gas meter Water heater Furnace Domestic gas stove • 425 CFH (Gas Meter) ≥ 195 CFH (Water Heater)+ 58.8 CFH (Furnace) + 63.7 CFH (Domestic gas stove) |
| Ignition failure |  <p>Digital pressure manometer</p> |  <p>Check gas supply pressure(Refer to page 23)</p> <p>A shifted seal narrows the inner diameter of CSST connector</p> |
| | Defective electrode gap and shape | <p>Defective electrode gap and shape disables ignition.</p> <ul style="list-style-type: none"> • Appropriate electrode gap: approx. 3~4mm(1/8") (replace if defective) • An ignition fail may occur due to improper gap, while discharge seems normal when checked via the flame monitoring window. Therefore, it is required to check the gap after disassembly. |

| Failure mode | Cause | Check method |
|------------------|--|--|
| Ignition failure |  <p data-bbox="501 875 815 902">Electrode gap 3.5~4.5mm(1/8")</p> |  <p data-bbox="1038 875 1235 902">Electrode gap error</p> |
| | No spark from electrode | <p data-bbox="603 927 1114 954">When no spark is made from the electrode at ignition:</p> <ul data-bbox="603 958 1394 1285" style="list-style-type: none"> • Remove the electrode and check if there is a crack on the insulator. • Adjust the gap if there is a discharge of electricity from the metallic part of the burner. • Ensure that the insulating gasket is installed between the electrode and burner casing. • Check the input power to the ignition transformer (AC 102~132 V). • If there is sufficient power to the ignition transformer, replace the ignition transformer. • Replace the PCB if there is no power or insufficient power supplied to the ignition transformer. • Check the insulator boots on the spark wires for cracks/holes. |
| | |  <p data-bbox="794 1883 999 1910">Ignition transformer</p> |

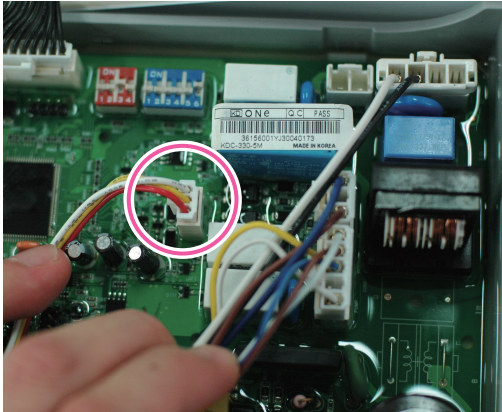
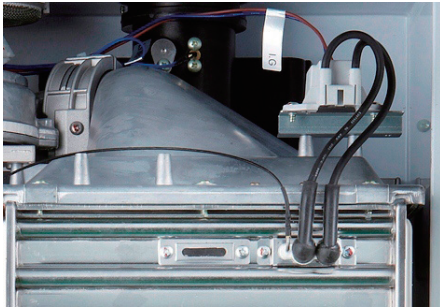
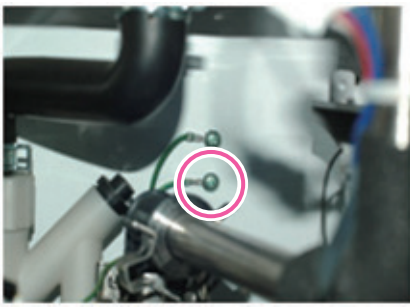
| Failure mode | Cause | Check method |
|---|---|--|
| Ignition failure | Main gas valve | <ol style="list-style-type: none"> 1. Check the primary/secondary power supply to the main gas valve. <ul style="list-style-type: none"> • Check, with a multimeter, if the input power is DC 22-24 V. 2. Replace the PCB if power is not supplied. 3. If power supply is normal, check if the coil is open. 4. Check if the solenoid valve works properly. <ul style="list-style-type: none"> • Feel or hear a click. |
| |    | <p>Gas block</p> <p>Check if the coil is open</p> <p>Check the voltage of the solenoid valve / White-Yellow, White-Red</p> |
| Repeated ignition-out | Flame sensing error | <ol style="list-style-type: none"> 1. Check the location of the flame, if there is any deformation or foreign substance, repair or replace the part. 2. Check the flame rod wire for proper connection and/or damage. 3. Check the grounding to the water heater case to verify proper grounding at the outlet. <ul style="list-style-type: none"> • If the ground wire is improperly connected or not making a good connection, remove and reattach the ground wire ensuring good contact with the case. • Or use a multimeter to measure the flame sensing current (normally 3~4 μA). |
| |   | <p>Measuring flame current</p> <p>Grounding wire position</p> |
| Flame loss and noise occurs at ignition | Check if there are any blockages in the gas orifice plate. | <p>Ignition failure will occur if the gas orifices are clogged.</p> <ul style="list-style-type: none"> • Remove the gas inlet pipe and check the orifice plate. |
| Improper air intake air supply | Rainwater intrusion | Check if rainwater has collected inside the unit from an improperly installed air intake pipe. |

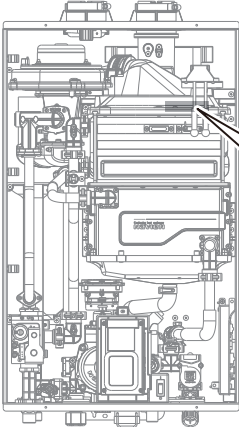
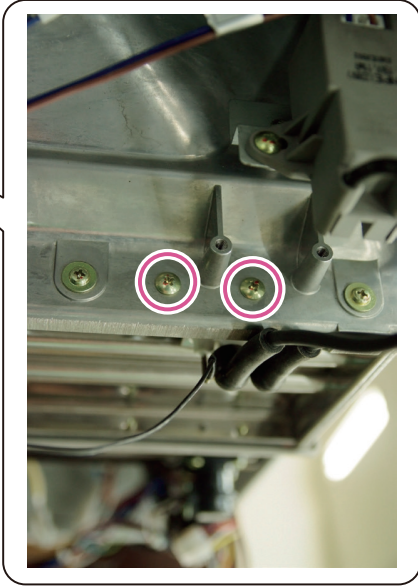
| Failure mode | Cause | Check method |
|---------------|-----------------|---|
| Other trouble | Screw loosening | <p data-bbox="603 320 1155 349">Tighten the ground connection screws on heat exchanger.</p> <div data-bbox="635 421 874 846">  </div> <div data-bbox="943 398 1362 981">  </div> |
| | Defective PCB | If the issue continues despite checking above items, replace the PCB. |

5.1.2 004Error

Error occurrence conditions and check items

| Error | Description |
|-------------------------------|--|
| E004 False-flame detection | <ol style="list-style-type: none"> Pre ignition false-flame If a flame signal is detected continuously for 3 seconds before combustion (stand-by, pre-purge, pre-ignition), a false-flame error E004 (automatically cleared) is displayed on the front panel and the system performs continuous post-purge and operates the pump. Post purge false-flame If a flame signal is detected continuously for 3 seconds when the system performs post-purge as fuel supply is stopped, a false-flame error 004E (automatically cleared) is displayed on the front panel and the system performs continuous post-purge and operates the pump. |
| Check items | <ol style="list-style-type: none"> Check if gas leaks due to defective seals on the main gas valve. Check if proper spark is discharged from the electrode. Check if gas is supplied within the proper pressure range. Check the PCB and replace if defective. |

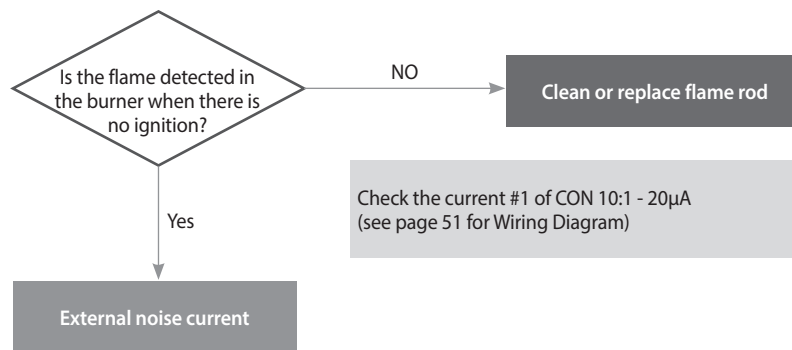

Check method

| Failure mode | Cause | Check method |
|-------------------------------|---|--|
| Flame before/after combustion | Leakage from main gas valve | Replace the gas flame if flame occurs before combustion or if there is remaining flame after combustion is stopped. |
| Error before/after combustion | Discharge of electricity from electrode | Spark discharges from electrode to flame sensor at ignition. <ul style="list-style-type: none"> Replace or correct location of flame detecting rod. |
| | Gas valve | Gas may leak as the main gas valve is pushed by the gas supply over the standard pressure. <ul style="list-style-type: none"> Check the supply pressure: NG: 3.5" ~ 10.5"W.C, LP: 8.0" ~ 13.0"W.C If the gas pressure is too high, notify the gas supplier about the issue, and if necessary, replace the gas valve. If there is a gas leak close the gas supply valve and repair the unit before using the system. |
| Other trouble | Defective PCB | If the issue continues despite the checking of items above, replace the PCB. |

5.1.3 012Error

Error occurrence conditions and check items

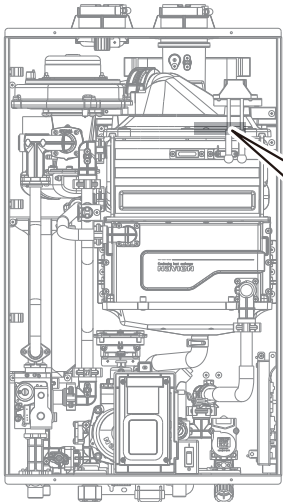
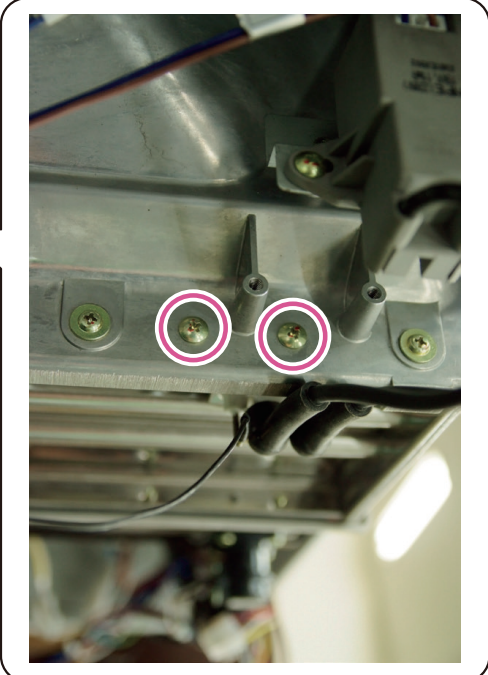
| Error | Description |
|--------------------|---|
| E012 Flame loss | If the system detects loss of flame during combustion, the system stops supplying fuel, attempts to restart, counts the incidents of flame loss, and if the incident occurs 20 times consecutively displays 012E (manually cleared) on the front panel. |
| Check items | <ol style="list-style-type: none"> 1. Measure, with a manometer the gas supply pressure (NG: 3.5" ~ 10.5" W.C, LP: 8" ~ 13.0" W.C) 2. Check the Gas meter Capacity. 3. Tighten the ground connection screws on heat exchanger. <div style="display: flex; align-items: center; justify-content: center;">   </div> <p>* Check the flame detection AD value for proper resistance. (refer to page 41~43)</p> <ol style="list-style-type: none"> 4. Check if the gas orifice is clogged. 5. Check if the PCB is working properly. |

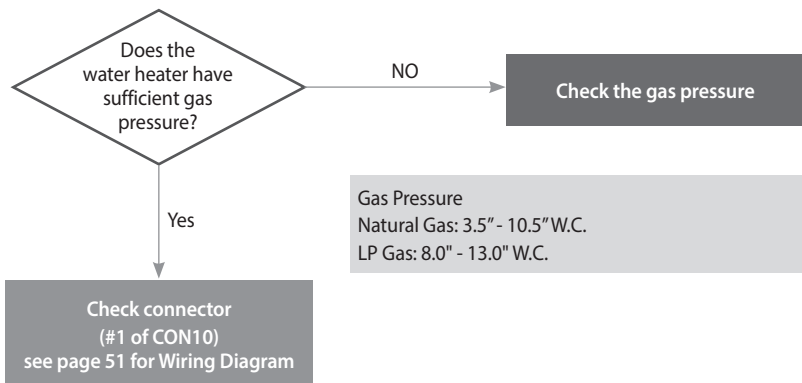

Check method

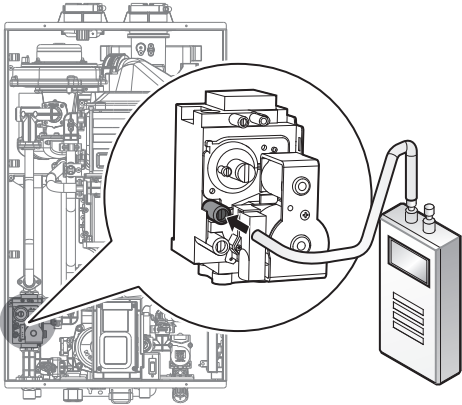
| Fault | Possible Causes | Check method | | | | |
|---|--|--|----------|--------|--|----|
| <p>Flame loss and noise occurs after ignition</p> | <p>Low gas supply pressure</p> | <ol style="list-style-type: none"> 1. Check the gas supply pressure. <ul style="list-style-type: none"> • NG: 3.5" - 10.5" W.C, LP: 8" - 13" W.C • LP pressure drop occurs frequently in the winter. 2. While the static pressure is normal, the use of another gas appliance may cause a possible drop in gas pressure to the unit. Therefore, it is required to check the dynamic pressure. <ul style="list-style-type: none"> × Check the static pressure: Gas supply pressure during stand by. Check the dynamic pressure: Gas supply pressure at (2nd stage MAX combustion setting: DIP S/W 1-1 ON) MAX combustion 3. Check the gas pipe connector. <ul style="list-style-type: none"> • If a CSST connector has been used, check to ensure that it is not been overtightened resulting in the seal obstructing gas flow. 4. Check the gas meter capacity (Example) <ul style="list-style-type: none"> • Gas meter Water heater Furnace Domestic gas stove 425 CFH (Gas Meter) ≥ 195 CFH (Water Heater)+ 58.8 CFH (Furnace) + 63.7 CFH (Domestic gas stove) 5. If too much pressure is exerted on the nut component while installing the gas pipe may reduce the gas supply due to packing push-out and Teflon blockage, etc. | | | | |
| | <div style="display: flex; align-items: center;">  <table border="1" style="margin-left: 20px;"> <thead> <tr> <th>Model</th> <th>Gas Type</th> <th>Offset</th> </tr> </thead> <tbody> <tr> <td>NPE-24A NPE-32A NPE-24S NPE-32S</td> <td>NG</td> <td>-0.04"±0.01"</td> </tr> </tbody> </table> </div> <p style="text-align: center; margin-top: 10px;">Check the offset values for low fire</p> <p style="text-align: center; margin-top: 10px;">Offset value for low fire</p> | Model | Gas Type | Offset | NPE-24A NPE-32A NPE-24S NPE-32S | NG |
| Model | Gas Type | Offset | | | | |
| NPE-24A NPE-32A NPE-24S NPE-32S | NG | -0.04"±0.01" | | | | |

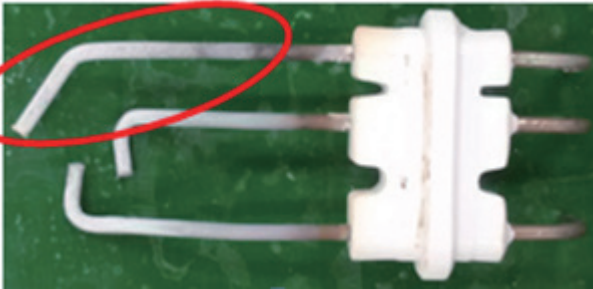
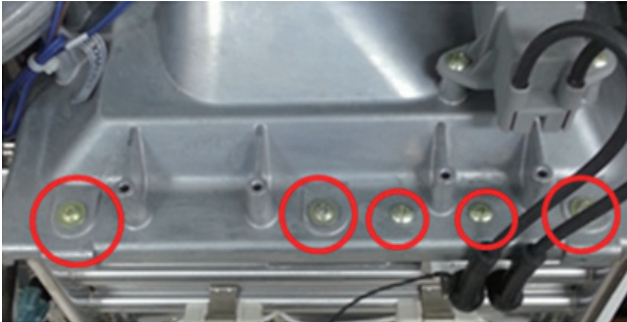
| Fault | Possible Causes | Check method |
|--|------------------------------------|--|
| Flame loss and noise occurs after ignition | Flame Rod (Electrode) | Replace the electrode or clean the fire detecting electrode. <ul style="list-style-type: none"> - Cause: Due to the properties of the electrode, the oxide film is created due to long-term exposure to the high temperature; therefore, errors may be caused in detecting the fires. - Check-up: Use sandpaper to clean the fire detecting electrode covered with oxide film or replace it.  |
| | Tightness of Screw or Ground Bolt | Check the tightness of the screw or ground bolt in the Chamber + SC heat exchanger. <ul style="list-style-type: none"> - Cause: Screw or ground bolt in the chamber and SC heat exchanger can be loosened by the vibration or external impact when operating the boiler (water heater). - Check-up: A failure in the current flow between the chamber and burner may cause the flame-out; therefore, the tightness (fastened) of the screw needs to be checked. [Fasten the ground screw (2EA) after fastening the assembly screw (3EA) in the front of the heat exchanger]  <p>[Location of assembly screw and ground bolt in heat exchanger]</p> |
| | Defected metal fiber | <ol style="list-style-type: none"> 1 Check the presence of debris in the metal fiber. 2 Check the sagging of the metal fiber and then the gaps with the electrode. [Gap between the electrode and metal fiber: 12mm] |
| Flame loss during 2nd stage | Blockage in the gas orifice plate. | Flame loss will occur if the gas orifices are clogged. <ul style="list-style-type: none"> • Remove the gas inlet pipe and check for debris; remove and clean the orifice plate if necessary. |
| Other trouble | Defective PCB | If the issue continues despite checking above items, replace the PCB. |

5.1.4 016Error





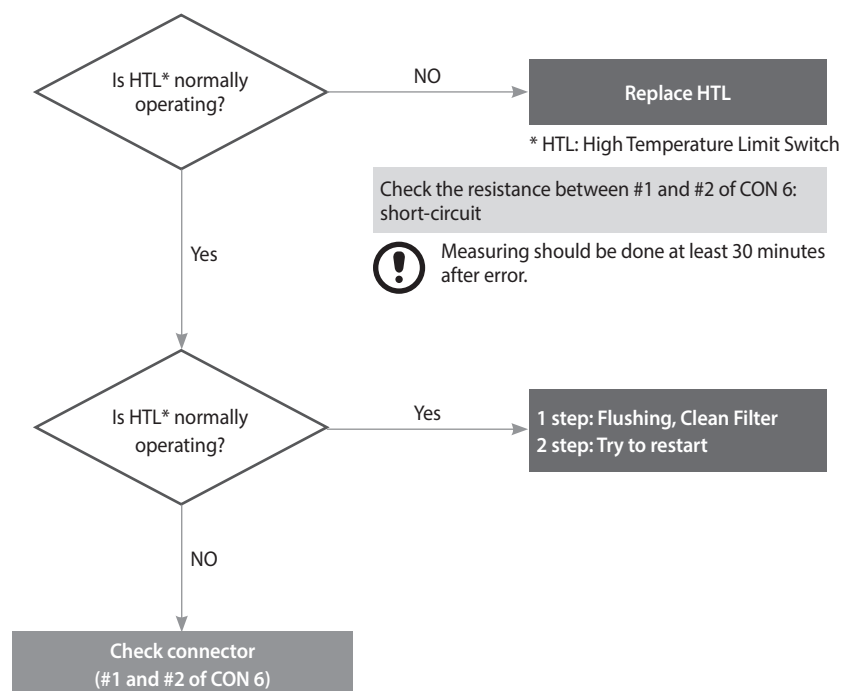





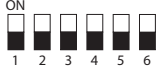

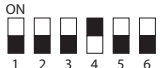
Error occurrence conditions and check items

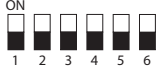
| Error | Description |
|---------------------------|---|
| E16 Bimetal overheated | If the overheat controller on the heat exchanger is initiated during combustion/standby of the water heater, the system displays the 016E (manually cleared) message on the front panel. The water heater switches into Lock-Out, and performs post-purge continuously and operates the pump. |
| Check items | <ol style="list-style-type: none"> 1. Check if the overheat controller is working properly. * Check resistance value or continuity. (refer to page 57) 2. Check the hot water temperature sensor. (refer to page 59) |

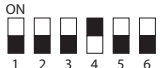

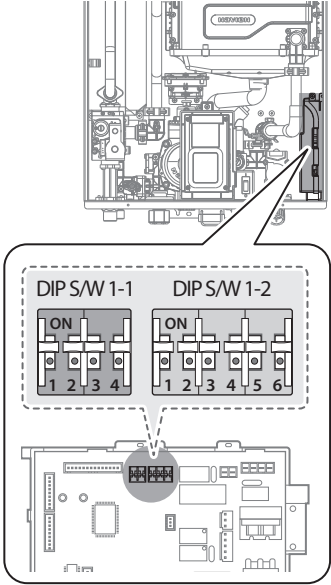
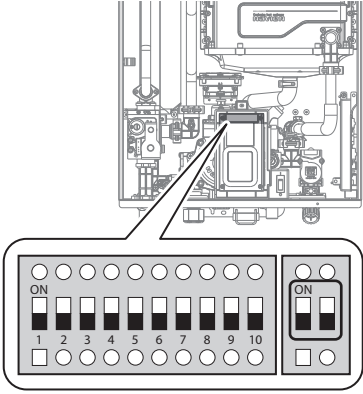
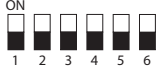
Check method

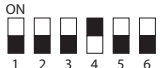
| Fault | Possible Causes | Check method |
|--------------------------|--|---|
| Defective safety device | Defective overheat controller | Check if the contact point of the overheat controller is defective. <ul style="list-style-type: none"> • Use a multimeter to see if the resistance is normal (0.3Ω) or abnormal (∞). |
| | <div data-bbox="474 479 892 860" data-label="Image"> </div> <p data-bbox="584 884 783 913">Overheat controller</p> | <div data-bbox="936 479 1390 860" data-label="Image"> </div> <p data-bbox="970 884 1358 943">Check if the overheat controller wire is disconnected (Normal 0.3Ω)</p> |
| Temperature sensor error | Defective hot water output temperature sensor | <ol style="list-style-type: none"> 1. If the hot water temperature is sensed lower than it actually is due to a defective sensor, check if the deviation of temperature is large due to a defective temperature sensor. <ul style="list-style-type: none"> • Check the output temperature displayed on the front panel. 2. Measure the temperature sensor resistance, and determine if the sensor is defective. |

| Fault | Possible Causes | Check method | | | | | | | | | | | | | | | | | | | | | | | | | | | | | | | |
|-----------------------------------|---|--|--|----------------|-----------|--|--|-----------|---|--|-----------|--|--|-----------|--|---|--------|----------|---------|--|---|--------------|-------------|-------|-----------------|------|---|----------|-------------|-------|-------------|------|--|
| Other trouble | Capacity setting | <ol style="list-style-type: none"> If the Max switch #1 of 1-1 is on, Set the switch to the normal operation position. PCB DIP S/W capacity setting error can suddenly increase the hot water temperature. | | | | | | | | | | | | | | | | | | | | | | | | | | | | | | | |
| | <ul style="list-style-type: none"> Check the PCB DIP S/W capacity setting.(refer to page 21) <table border="1" data-bbox="416 645 1031 1059"> <thead> <tr> <th></th> <th>DIP SWITCH 1-1</th> <th>DIP SWITCH 1-2</th> </tr> </thead> <tbody> <tr> <td>NPE-24AWE</td> <td></td> <td> ON  </td> </tr> <tr> <td>NPE-24SWE</td> <td> ON  </td> <td> ON  </td> </tr> <tr> <td>NPE-32AWE</td> <td></td> <td> ON  </td> </tr> <tr> <td>NPE-32SWE</td> <td></td> <td> ON  </td> </tr> </tbody> </table> <ul style="list-style-type: none"> 2-switch Panel: <table border="1" data-bbox="416 1122 1031 1361"> <thead> <tr> <th>Switch</th> <th>Function</th> <th colspan="2">Setting</th> </tr> </thead> <tbody> <tr> <td rowspan="2">1</td> <td rowspan="2">Cascade Vent</td> <td>Common Vent</td> <td>1-OFF</td> </tr> <tr> <td>Individual Vent</td> <td>1-ON</td> </tr> <tr> <td rowspan="2">2</td> <td rowspan="2">Gas Type</td> <td>Natural Gas</td> <td>2-OFF</td> </tr> <tr> <td>Propane Gas</td> <td>2-ON</td> </tr> </tbody> </table> | | DIP SWITCH 1-1 | DIP SWITCH 1-2 | NPE-24AWE | | ON  | NPE-24SWE | ON  | ON  | NPE-32AWE | | ON  | NPE-32SWE | | ON  | Switch | Function | Setting | | 1 | Cascade Vent | Common Vent | 1-OFF | Individual Vent | 1-ON | 2 | Gas Type | Natural Gas | 2-OFF | Propane Gas | 2-ON |   |
| | | DIP SWITCH 1-1 | DIP SWITCH 1-2 | | | | | | | | | | | | | | | | | | | | | | | | | | | | | | |
| | NPE-24AWE | | ON  | | | | | | | | | | | | | | | | | | | | | | | | | | | | | | |
| NPE-24SWE | ON  | ON  | | | | | | | | | | | | | | | | | | | | | | | | | | | | | | | |
| NPE-32AWE | | ON  | | | | | | | | | | | | | | | | | | | | | | | | | | | | | | | |
| NPE-32SWE | | ON  | | | | | | | | | | | | | | | | | | | | | | | | | | | | | | | |
| Switch | Function | Setting | | | | | | | | | | | | | | | | | | | | | | | | | | | | | | | |
| 1 | Cascade Vent | Common Vent | 1-OFF | | | | | | | | | | | | | | | | | | | | | | | | | | | | | | |
| | | Individual Vent | 1-ON | | | | | | | | | | | | | | | | | | | | | | | | | | | | | | |
| 2 | Gas Type | Natural Gas | 2-OFF | | | | | | | | | | | | | | | | | | | | | | | | | | | | | | |
| | | Propane Gas | 2-ON | | | | | | | | | | | | | | | | | | | | | | | | | | | | | | |
| Primary heat exchanger overheated | <p>The surface temperature rises due to heavy scale deposits in the primary heat exchanger.</p> <ul style="list-style-type: none"> Flush the primary heat exchanger. | | | | | | | | | | | | | | | | | | | | | | | | | | | | | | | | |
| Defective PCB | If the issue continues despite checking the items above, the PCB is defective. | | | | | | | | | | | | | | | | | | | | | | | | | | | | | | | | |

5.1.5 030Error

Error occurrence conditions and check items

| Error | Description |
|--|--|
| E030 Exhaust gas temperature error | <p>If the overheat controller on the top of the exhaust duct is initiated, the system displays the heat exchanger bimetal overheat message 30E (cleared manually) on the front panel. The water heater switches into Lock-Out, and performs post-purge continuously and operates the pump. Overheating controller operates when the temperature exceeds 110 °C (230 °F) for 10 minutes or over.</p> <ol style="list-style-type: none"> 1. When the controller detects the exceeding temperature of 110 °C (230 °F) for 10 minutes or over, "E030" error code will display and perform post-purge. → Automatically cleared. 2. When the controller detects the exceeding temperature of 60 °C (140 °F) while performing post-purge. → Manually cleared. 3. When the controller detects the exceeding temperature of 110 °C (230 °F) for 10 seconds or over three times or more after the error is automatically cleared. → Manually cleared. |
| Check items | <ol style="list-style-type: none"> 1. Check if the overheat controller operates normally. 2. Check if the PCB works properly. |

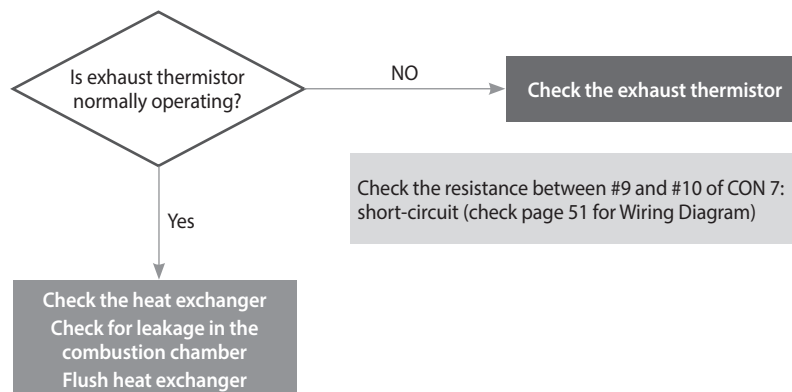

Check method

| Fault | Possible Causes | Check method |
|---------------------------|---|--|
| Heat exchanger overheated | Damaged or clogged heat exchanger | <ol style="list-style-type: none"> 1. The error occurs due to high exhaust gas temperature caused by a damaged or clogged heat exchanger. 2. Flush the heat exchanger to remove scale deposits. 3. Replace the heat exchanger if it is damaged or cannot be unclogged. |
| Defective part | Defective overheat controller | Defective contact point of the exhaust gas overheat controller 110 °C (230 °F) Max <ul style="list-style-type: none"> • Check connection of the overheat controller. • If the resistance is abnormal, replace the temperature sensor. (refer to page 59) • Check the output temperature displayed on the PCB. |
| |  <p>Check if the hot water temperature sensor is open (Error type : MΩ Open)</p> | |
| Other trouble | Defective PCB | If the issue continues despite checking the items above, replace the PCB. |

5.1.6 046Error

Error occurrence conditions and check items

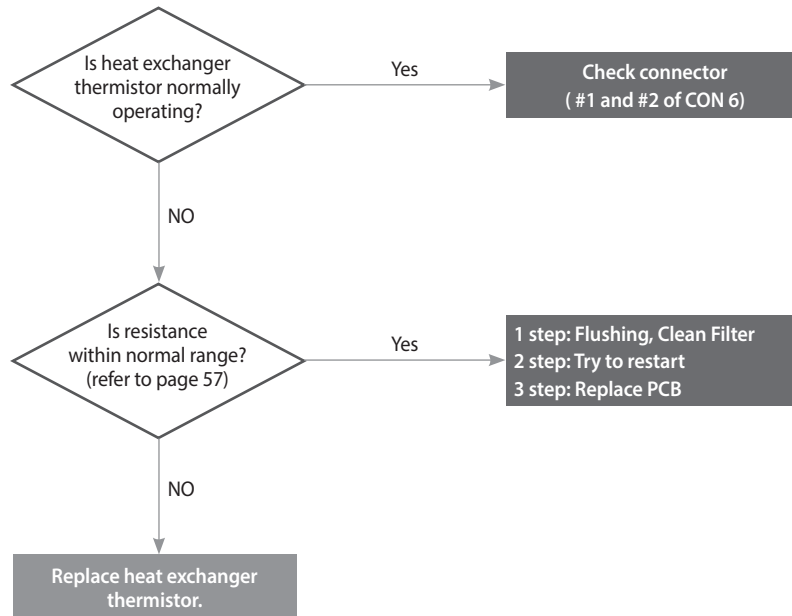

5.1.7 047Error

Error occurrence conditions and check items

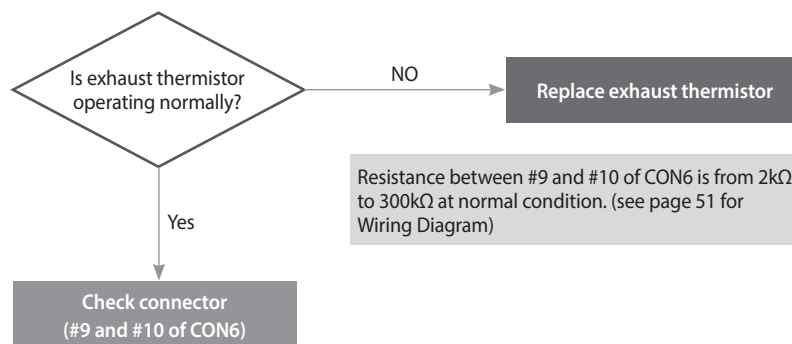

5.1.8 060Error

Error occurrence conditions and check items

| Error | Description |
|----------------------------|--|
| E060 Dual Venturi error | This error message is displayed on the front panel if the wiring is disconnected or the Dual Venturi malfunctions. The water heater switches into Lock-Out, and performs post-purge continuously and operates the pump. |
| Check items | <ol style="list-style-type: none"> 1. Check that the Dual Venturi is operating correctly. 2. Check that the wiring harness is connected correctly and the cables are not damaged. |

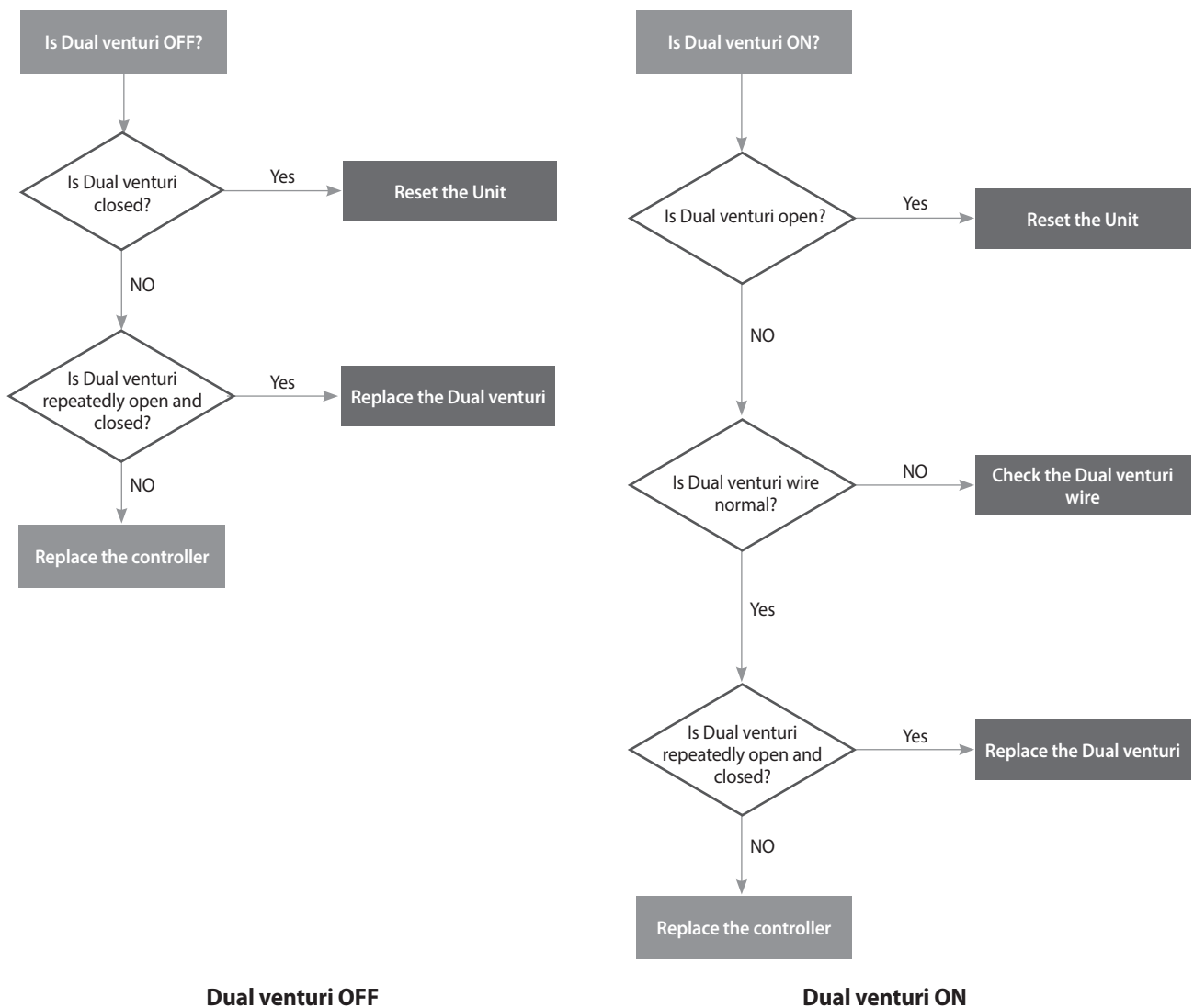

Check method

| Fault | Possible Causes | Check method |
|---------------------------|---|--|
| Dual Venturi action error | Defective Dual Venturi cable or harness | <ol style="list-style-type: none"> 1. Disconnect all cables from the Dual Venturi. 2. Using a multi-meter, test the Dual Venturi electrical wiring. |
| | Dual Venturi not operating | <ol style="list-style-type: none"> 1. Turn off the power to the unit using the main power switch (do not use the front panel power button) and wait for 10 seconds. 2. Turn on the power. 3. Wait until Fan Auto Adjusting is complete. 4. Enter the Dual Venturi Test Mode and perform a test. <ol style="list-style-type: none"> 1) Repeat the test at least twice. Turning the unit ON and OFF once makes one test cycle. ON → OFF → ON → OFF → is the minimum sequence. 2) Confirm that the Dual Venturi is operating correctly. <ol style="list-style-type: none"> a. Listen to the Dual Venturi while it is running and check for operational noise (clicks at unit ON and unit OFF). b. If operational noise cannot be heard because of ambient noise, disassemble the Dual Venturi and perform a visual inspection. 5. If error message (E060) occurs, replace the Dual Venturi. 6. If a Dual Venturi error does not occur, replace the APS. |

5.1.9 109Error

Error occurrence conditions and check items

| Error | Description |
|-----------------------------|---|
| E109 Fan motor RPM error | <p>The system checks the RPM signal after the fan starts to run, and displays the error message 109E (cleared manually) in the following cases:</p> <ol style="list-style-type: none"> 1. If the RPM remains low or close to 0, the system determines RPM error, and the water heater switches into Lock-Out (gas valve and ignition transformer locked). (However, the air pressure sensor should be normal.) 2. If the RPM signal of low or close to 0, is detected for 3 seconds during combustion, the system stops combustion, and the water heater switches into Lock-Out. (However, the air volume sensor should be normal.) |
| Check items | <ol style="list-style-type: none"> 1. Check if the fan motor works normally using the component test mode (refer to page 46). 2. Check the power supply to the fan (Black + Red, approx. DC 127~184V) 3. If RPM is significantly low while the fan works and the power supply is normal, replace the fan motor. 4. If the fan connector is wet due to any reason including leakage, take corrective action by powering the unit OFF, then drying the components completely before continuing operation. 5. Check for loose connection of white connector that attaches the fan motor to the PCB. |

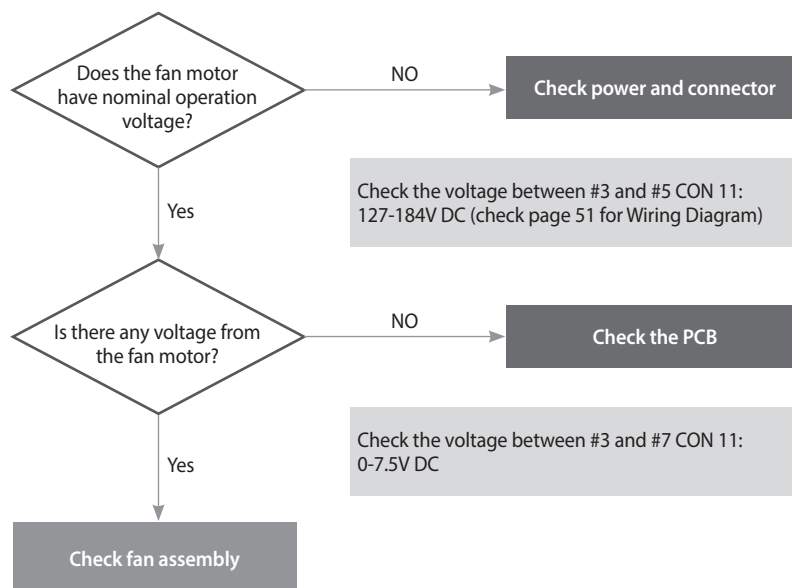

Check method

| Fault | Possible Causes | Check method |
|---------------------|-------------------|--|
| Fan action error | No fan operation | <ol style="list-style-type: none"> 1. Check the power supply to the blower. <ul style="list-style-type: none"> • Black+Red, approx. DC 127~184 V 2. Replace the PCB if voltages are abnormal. (When replacing the PCB, turn off the unit and then wait for at least 10 seconds before proceeding.) 3. If the issue continues despite the checking the items above, replace the fan motor. |
| | | <div data-bbox="657 638 1185 1021" data-label="Image"> </div> <p data-bbox="708 1046 1136 1072">Check if the fan motor wire is disconnected</p> |
| Fan motor RPM error | Defective rotator | <ol style="list-style-type: none"> 1. If RPM is significantly low while the fan is operating and the power supply is normal. Follow the instructions listed below and replace the fan. <ol style="list-style-type: none"> 1) Unplug the power cable to the unit and then wait for 10 seconds until the remaining SMPS voltage completely discharges. 2) Disconnect the fan cable and then re-connect it. 3) Plug the power cable and turn on the unit. 4) Fan Auto Adjusting verifies error conditions for error code E109. If an E109 error occurs, enter the Fan Test Mode and verify fan RPM and APS input voltage.(Display: ex. H.320 = 3200 RPM) 5) If RPM is low or there is a sensor circuit error, replace the fan. <div data-bbox="695 1417 746 1473" data-label="Image"> </div> <p data-bbox="762 1417 1426 1473">Connection and disconnection of the fan cables while the unit is ON may cause electrical damage to the fan drive circuit or main PCB.</p> 2. If the issue continues despite checking the items above, replace the PCB. |

5.1.10 110Error

Error occurrence conditions and check items

| Error | Description |
|------------------------------------|---|
| <p>E110 Air pressure error</p> | <p>The system senses the air volume and the RPM signal, and displays 110E on the front panel in the following cases:</p> <ol style="list-style-type: none"> 1. When the initial fan auto-adjust is not performed. 2. When the unit capacity reaches up to 95% of the maximum heat during combustion, and APS is not up the standard value. |
| <p>Check items</p> | <ol style="list-style-type: none"> 1. Check if the venturi (burner) hole is clogged. 2. Check if the condensation drain line or the drain is clogged. 3. Check the flue and exhaust to verify proper installation and clearances. (Circulation of exhaust gas generates noise.) 4. Check if the air supply/exhaust flue is clogged (rainwater may collect inside from an improperly installed air supply/exhaust pipe). 5. Defective air pressure sensor or PCB. |

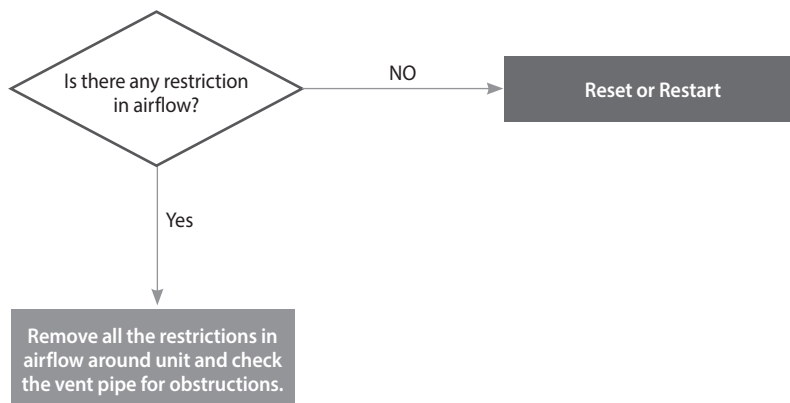

Check method

| Fault | Possible Causes | Check method |
|---------------------------------------|--|--|
| 110E Exhaust blockage | Abnormal flow of intake air supply / exhaust | <ol style="list-style-type: none"> If 110E occurs intermittently during ignition or combustion, compare the standard RPM with the current RPM at Min / Max combustion (dip switch 1-1&1-2). If the current RPM is higher than normal, check the following: <ul style="list-style-type: none"> Air supply / exhaust vent for any blockages. Blocked condensate drain If the air pressure sensor hose is broken or clogged. Replace the old PCB with the latest version. |
| Condensate drain error | Condensate drain error | <p>Exhaust air is blocked due to condensate drain error.</p> <ul style="list-style-type: none"> Check if the condensate hose or the siphon is frozen. Check if the condensate hose is kinked. Remove bottom of trap and verify it is not blocked. |
| Defective air supply/ exhaust flue | Deformed or clogged flue | <ol style="list-style-type: none"> Check the exterior of the flue for damage and obstructions. Check if rainwater is collected due to vertical installation of the air intake pipe. Check the vent termination. <ul style="list-style-type: none"> Ensure that the vent termination is at least 12"(305mm) the highest anticipated snow line, or as required by local codes, whichever is greater. |
| | Exhaust gas flows in through the supply pipe | <p>If the exhaust gas enters into the air supply pipe, abnormal combustion may cause E110.</p> <ul style="list-style-type: none"> Check the installation of the flue. |

5.1.11 407Error

Error conditions and Check Items

| Error | Description |
|--|---|
| E407 Hot water outlet Temperature sensor open / short | If an error (open: -10 °C (14 °F) or lower) in the Hot water outlet temperature sensor is detected, the system displays the 407E error on the front panel. If this occurs, the water heater initiates shutdown. |
| Check items | <ol style="list-style-type: none"> Check if the Hot water outlet temperature sensor connector is wet due to any reason, including leakage. Check the Resistance of the Hot water outlet temperature sensor. Replace the defected Hot water outlet temperature sensor. Replace the controller. |

5.1.12 421Error

Error conditions and Check Items

| Error | Description |
|--|--|
| E421 Heat exchanger input temperature sensor open | If an error (open: -10 °C (14 °F) or lower) in the heat exchanger input temperature sensor is detected, the system displays the 421E error on the front panel. If this occurs, the water heater initiates shutdown. |
| Check items | <ol style="list-style-type: none"> 1. Check if the heat exchanger input temperature sensor connector is wet due to any reason, including leakage. 2. Replace the defected heat exchanger input temperature sensor. 3. Replace the controller. |

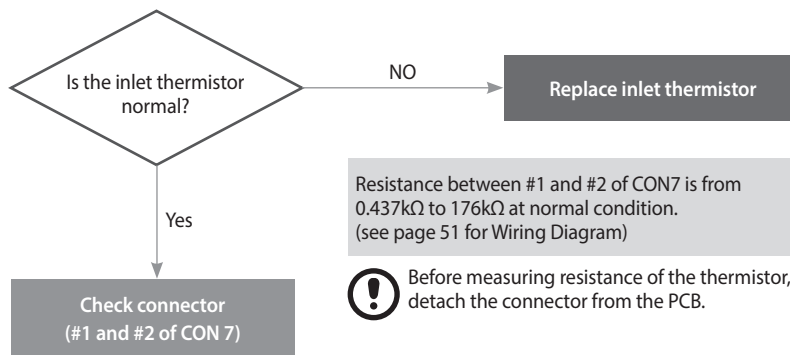

Check method

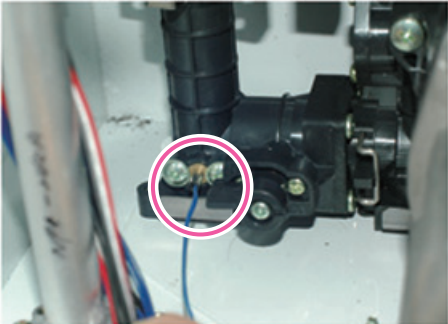
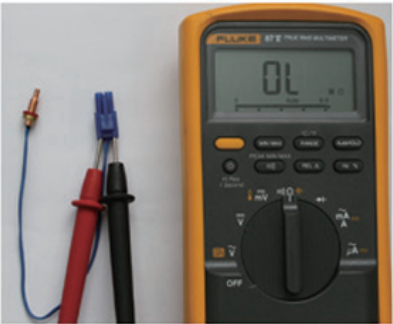
| Fault | Possible Causes | Check method |
|------------------|--|--|
| Defective sensor | Defective temperature sensor connector | Check if the temperature sensor is open and if the connector is connected properly. |
| | Temperature sensor | Check the resistance of the temperature sensor. (Defective if it is 30kΩ or higher) <ul style="list-style-type: none"> • Replace the temperature sensor if the resistance value is abnormal. • Check the temperature displayed on the front panel. |
| Possible Issues | Defective PCB | If the issues continue despite checking the items above, replace the PCB. |
| |  <p>Heat exchanger input temperature sensor / connector</p> |  <p>Check if the secondary water temperature sensor is open Error type : MΩ Open</p> |

5.1.13 432Error

Error occurrence conditions and check items

| Error | Description |
|--|---|
| E432 Cold Water water temperature sensor open | If an error (open: -10 °C (14 °F) or lower) in the cold water temperature sensor is detected, the system displays the 432E (cleared automatically) error message on the front panel. The water heater initiates shutdown mode. |
| Check items | <ol style="list-style-type: none"> 1. Check if the cold water temperature sensor is open and if the connector is attached properly. 2. Check the defect of the cold water temperature sensor. 3. Defective PCB |

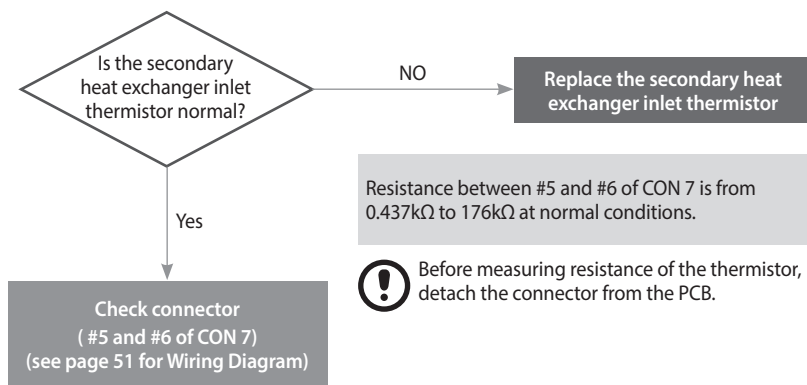

Check method

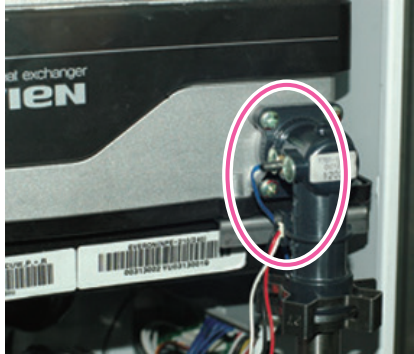
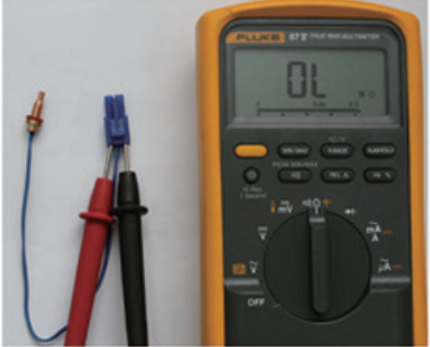
| Fault | Possible Causes | Check method |
|------------------|--|---|
| Defective sensor | Defective temperature sensor connector | Check if the cold water temperature sensor is open and if the connector is attached properly. |
| | Temperature sensor | <ul style="list-style-type: none"> • Measure the temperature sensor resistance. (Defective if it is 30kΩ or higher.) • Replace the temperature sensor if the resistance is abnormal |
| Other trouble | Defective PCB | If the issue continues despite the checking the items above replace the PCB. |
| |  <p>Direct water temperature sensor</p> |  <p>Check if the water temperature sensor is open. Error type: MΩ Open</p> |

5.1.14 434Error

Error occurrence conditions and check items

| Error | Description |
|--------------------------------------|--|
| E434 Water Adjustment valve error | <p>If the water adjustment valve does not work properly due to a defective feedback sensor, water adjustment valve, or PCB board, the system displays 434E (cleared automatically/manually).<only when in CASCADE mode></p> <ul style="list-style-type: none"> Water adjustment valve error – The system commands opening of the water adjustment valve, but the valve remains closed. [Check the feedback sensor.] (Cleared manually) If the Water adjustment valve sensor open/short-circuit is detected, the system displays an error message. If flow is sensed, the system clears the error automatically and provides the hot water. If open/short-circuit is detected after hot water is used, the system displays the error message. |
| Check items | <p>If the 434 error occurs, connect the Water adjustment valve to the PCB. The valve must be kept open when the water heater is not operating. If the PCB is defective, the motor keeps operating and the valve continues to make attempts to open/close.</p> <ol style="list-style-type: none"> Defective water adjustment valve Defective PCB Check the operation of the water adjustment valve using the Component Test mode (refer to page 46). |

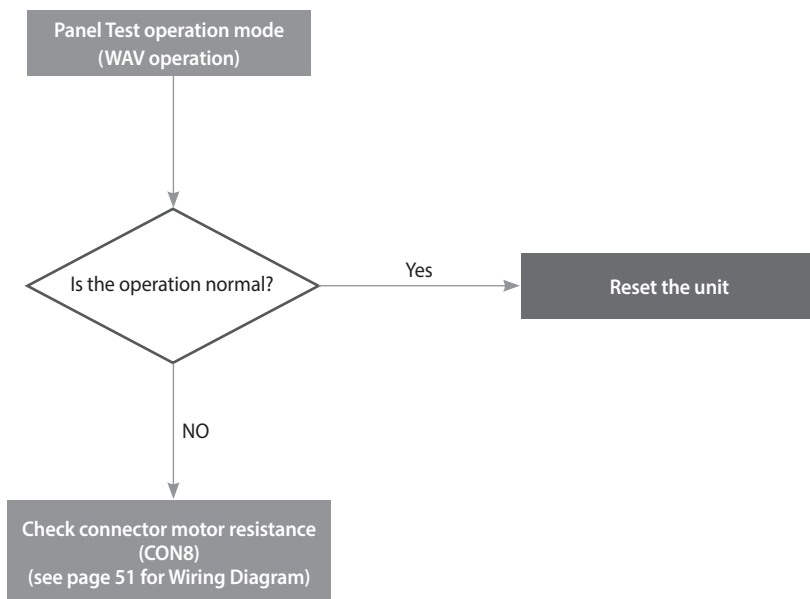

Check method

| Fault | Possible Causes | Check method |
|-------------------------------------|--|---|
| Remote controller / PCB error | <p>Malfunction of water adjustment valve</p> <p>Defective water adjustment valve</p> | <p>If an error occurs in the cascade system, disconnect the cascade cable and check the system in the following procedure:</p> <ol style="list-style-type: none"> 1. Check the operation of the water adjustment valve using the Component Test mode (refer to page 46). 2. If the PCB is defective, the motor keeps operating as the water adjustment valve is OPEN or CLOSED, or the valve repeats open/close. 3. Replace the water adjustment valve for other symptoms. 4. As a temporary measure, you can disassemble the water adjustment valve, open it manually, and separate the power cable of the water adjustment valve. |
| Water heater works but error occurs | Defective water adjustment valve sensor | <ol style="list-style-type: none"> 1. Open or short-circuit of the flow control valve sensor. 2. Check the connector assembly and wiring state of the water adjustment valve feedback sensor. 3. Check the operation of the water adjustment valve using the Component Test mode (refer to page 46). |

Emergency measures for a blocked water adjustment valve * (refer to page 46 for Component Test mode information)

1. Switch off power, shut off water supply to the unit, and drain water from the unit.
2. Remove the top/bottom clips of the water adjustment valve.
3. Disassemble the motor and open the lid.
4. Turn the water adjustment valve axis disk counterclockwise until it does not turn anymore.
5. Pull out the water adjustment valve power connector.
6. Reconnect power and start the unit while using hot water.

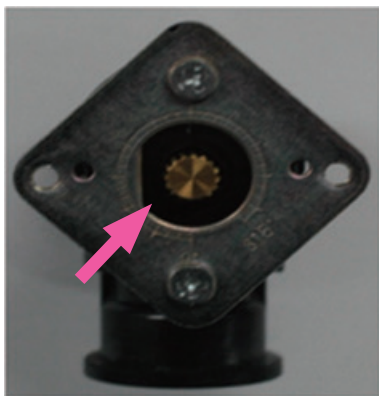
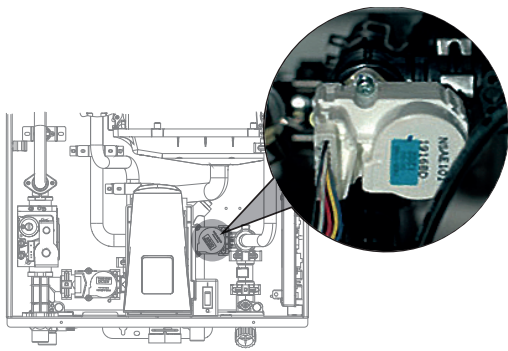

Turn the gear clockwise to open the valve manually



Closed Position

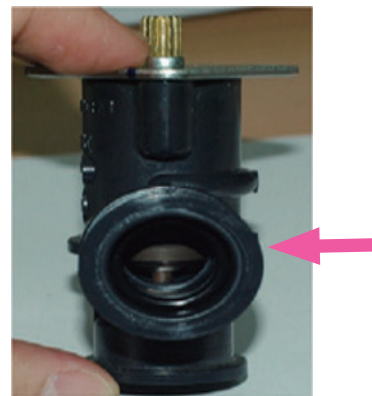

Open Position

5.1.15 438Error ("A" models only)

Error occurrence conditions and check items

| Error | Description |
|--------------------|---|
| E438 Pump error | Connect the power, start the pump, and check if the system senses water flow. If flow is not sensed after the pump has started, the system displays 438E (cleared automatically) on the front panel. |
| Check items | <ol style="list-style-type: none"> 1. Defective flow sensor. 2. Defective pump. * Check water filter for debris. * Check for locked air in the pump. 3. Defective PCB. * Check the operation of the pump and flow sensor using the Component Test mode (refer to page 46). |

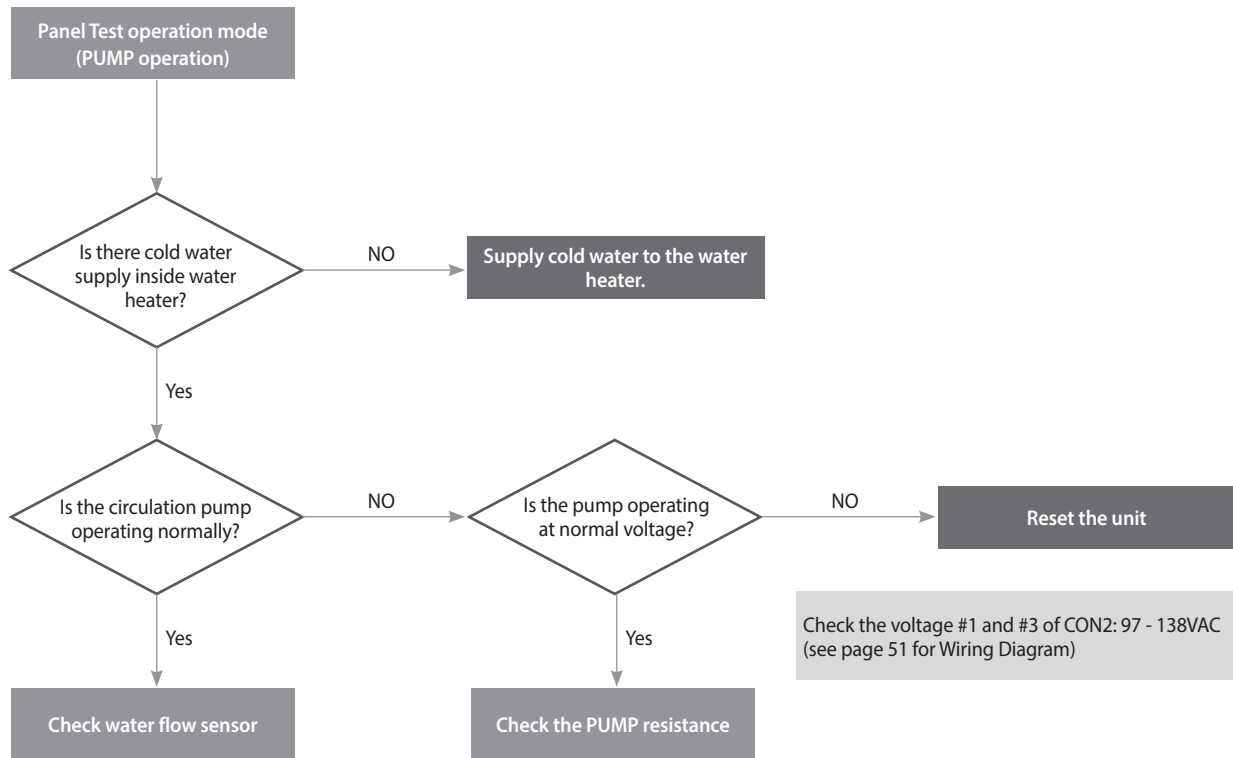

Check method

| Fault | Possible Causes | Check method |
|------------------|-----------------------|--|
| Pump Malfunction | Defective flow sensor | <p>Check the current flow rate displayed on the front panel. The flow sensor is defective if the water flow displayed is 0.0 gal/min when the pump is operating or when water is discharged from the hot water tap.</p> |
| | | <div data-bbox="671 504 1129 898" data-label="Image"> </div> <p data-bbox="738 920 1062 949">Direct water temperature sensor</p> |
| Defective pump | Defective pump | <ol style="list-style-type: none"> 1. Check if the pump is working normally. 2. Check the pump power cable connector and verify that the wiring is properly installed. 3. Check the power supply to the pump (AC 102-132 V). 4. Check for air in the system. |
| | | <div data-bbox="403 1223 793 1727" data-label="Image"> <p data-bbox="507 1756 687 1785">Circulation pump</p> </div> <div data-bbox="836 1218 1422 1731" data-label="Image"> <p data-bbox="946 1756 1310 1785">Circulation pump wire: Yellow-White</p> </div> |
| Other trouble | Defective PCB | <p>If the issue continues despite checking the items above, the PCB could be defective. Replace the PCB.</p> |

5.1.16 439Error

Error occurrence conditions and check items

| Error | Description |
|---------------------------|--|
| E439 Flow sensor error | As one or more units are operating in the cascade system, if no flow is detected while the system opens the water adjustment valve, the system considers it as a defective flow sensor. The system displays 439E (cleared manually) on the front panel and switches the unit operation into the Lock-Out mode (gas valve and ignition transformer locked). |
| Check items | <ol style="list-style-type: none">1. Check the supply of cold water while the cascade system is disabled. (frozen/locked valve).2. Defective flow sensor.3. Defective PCB. |

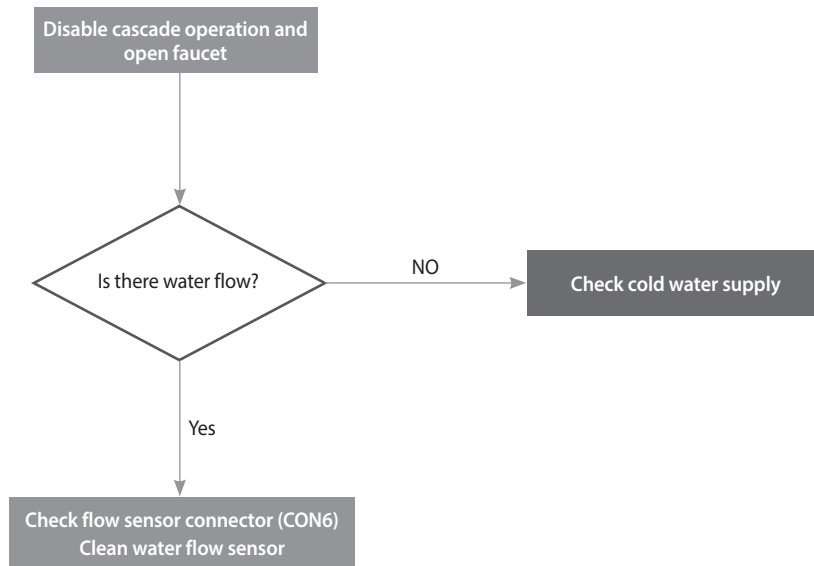

Check method

| Fault | Possible Causes | Check method |
|--------------------------|-------------------------|--|
| No hot water flow | Cold water supply error | <ol style="list-style-type: none"> 1. Check if the water adjustment valve is opening/closing properly. 2. Check if the cold water line is frozen. 3. Check if the cold water filter is clogged. |
| Water heater not working | Defective flow sensor | <ol style="list-style-type: none"> 1. Check the current flow displayed on the front panel. <ul style="list-style-type: none"> • If the flow sensor is defective, the displayed flow value is 0.0 while water flows from the hot water tap. • Remove the flow sensor and blow into it. The rotation detector on the flow sensor is defective if the impeller rotates and display remains 0.0. <p>* Component Test mode may also be used to check the operation of the flow sensor (refer to page 46).</p> 2. Check connector assembly and contact of the flow sensor. 3. Check the input voltage of the flow sensor. <ul style="list-style-type: none"> • Operating voltage (Black + Red) : Defective PCB if DC 12 V is not supplied. 4. Replace the flow sensor if no flow is detected while the operating voltage is normal. |
| Other trouble | Defective PCB | If the issue continues despite the checking of items above the PCB is defective. |

Emergency measures for a defective flow sensor

Replacement of the part is usually required for the water heater to operate when an error occurs with the flow sensor. If it is impossible to replace the part immediately, use the following emergency measures.

If the flow sensor impeller is stuck due to foreign substances:

Remove the flow sensor and blow air through the part from the inlet side. If the impeller does not rotate, disassemble the impeller, and remove the foreign substance before reassembling it.

If the flow displayed on the front panel is 0.0, and the impeller rotates when you blow into it, the flow sensor will need to be replaced.

1. Drain water from the unit, then remove the 4 screws and retaining clips from the flow sensor.

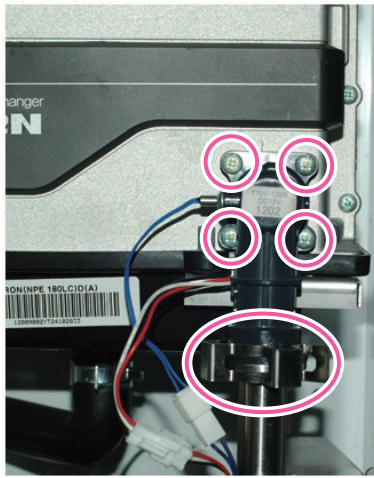

2. Detach the 2 wire connectors that connect the flow sensor to the PCB.

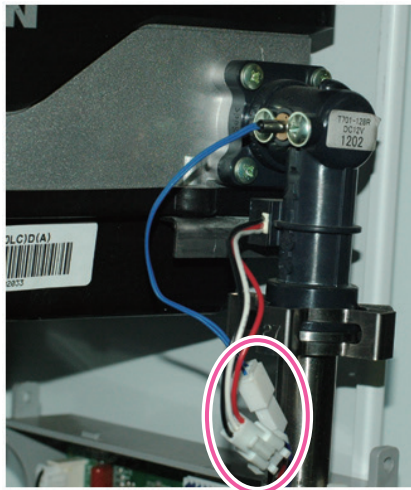

3. Blow air through the flow sensor. Check that the impeller rotates freely.

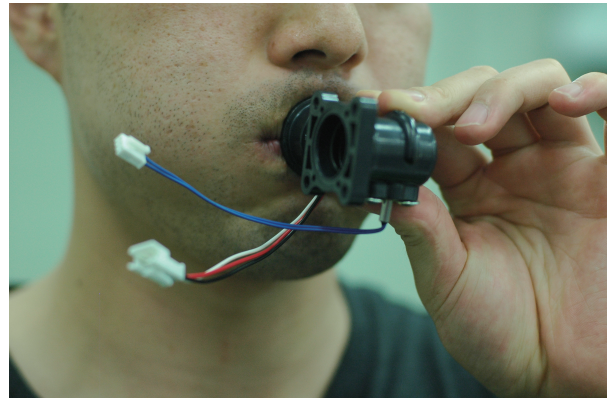

5.1.17 441Error

Error occurrence conditions and check items

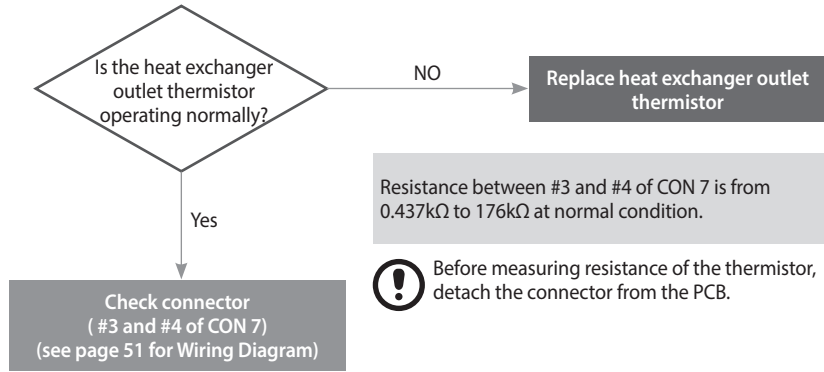

5.1.18 445Error

Error occurrence conditions and check items

| Error | Description |
|----------------------------|--|
| E445 Mixing valve error | <p>If the mixing valve does not work properly due to a defective feedback sensor, mixing valve, or PCB board, the system displays 445E (cleared automatically/manually).</p> <ul style="list-style-type: none"> Mixing valve error – The system commands opening of the mixing valve, but the valve remains closed. [Check the feedback sensor.] (Cleared manually) If a mixing valve sensor open or short-circuit is detected, the system displays an error message. If flow is detected, the system clears the error automatically and provides hot water. If an open or short-circuit is detected after hot water is used, the system displays the error message. |
| Check items | <p>If the 445 error occurs, connect the mixing valve to the PCB. The valve must be kept open when the water heater is not operating. If the PCB is defective, the motor keeps operating and the valve continually attempts to open or close the valve.</p> <ol style="list-style-type: none"> Defective mixing valve Defective PCB Check the operation of the mixing valve using the Component Test mode (refer to page 46). |

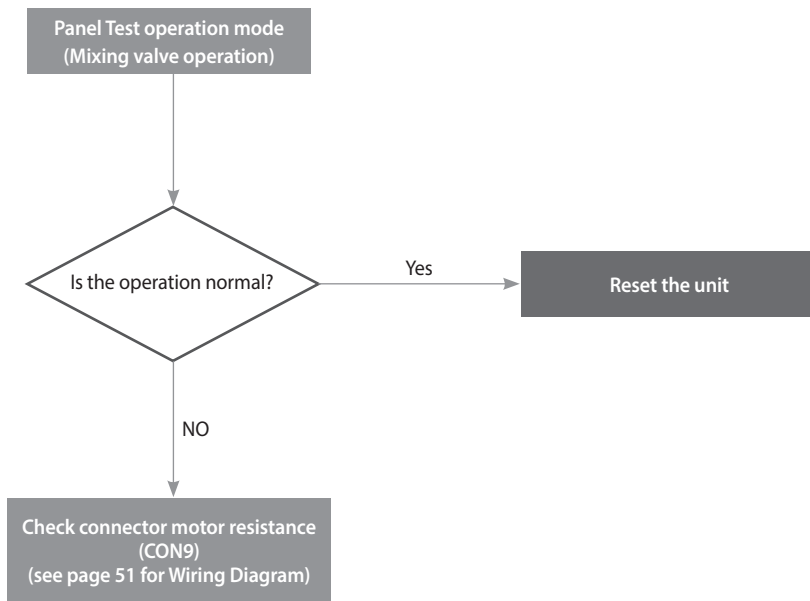

Check method

| Fault | Possible Causes | Check method |
|--|--|--|
| Remote controller / PCB error | Malfunction of mixing valve Defective mixing valve | <ol style="list-style-type: none"> 1. Check the operation of the mixing valve using the Component Test mode (refer to page 46). 2. If the PCB is defective, the motor keeps operating as the mixing valve is OPEN or CLOSED, or the valve repeats open/close. 3. Replace the mixing valve for other symptoms. 4. As a temporary measure, you can disassemble the mixing valve, open it manually, and separate the power cable of the mixing valve. |
| Water heater works but error occurs | Defective mixing valve sensor | <ol style="list-style-type: none"> 1. Open or short-circuit of the flow control valve sensor. 2. Check the connector assembly and wiring state of the mixing valve feedback sensor. 3. Check the operation of the mixing valve using the Component Test mode (refer to page 46). |

Emergency measures for a blocked mixing valve * (refer to page 46 for Component Test mode information)

1. Switch off power, shut off water supply to the unit, and drain water from the unit.
2. Remove the top/bottom clips of the mixing valve.
3. Disassemble the motor and open the lid.
4. Turn the mixing valve axis disk counterclockwise until it does not turn anymore.
5. Pull out the mixing valve power connector.
6. Reconnect power and start the unit while using hot water.

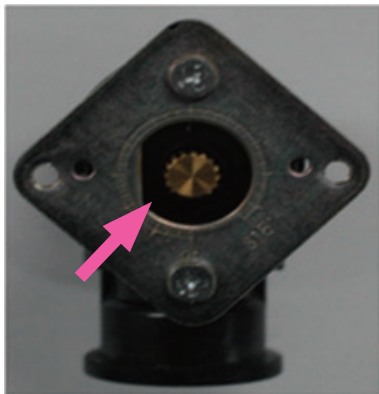
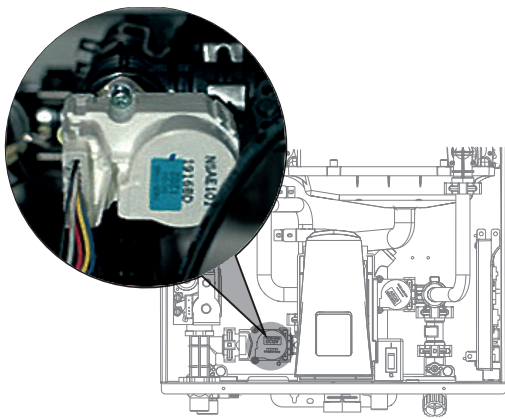

Turn the gear clockwise to open the valve manually



Closed Position

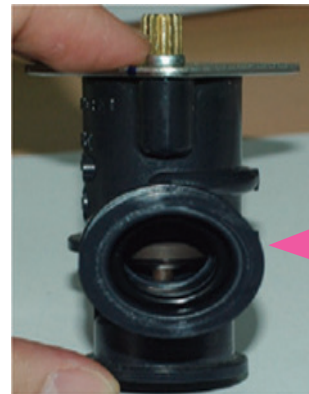

Open Position

5.1.19 515Error

Error occurrence conditions and check items

| Error | Description |
|-------------|---|
| E515 error | If an error occurs in the internal circuit of the PCB (e.g., resistance, transistor or relay fault), the system displays 515E (cleared manually) on the PCB. |
| Check items | <ol style="list-style-type: none"> 1. Defective PCB 2. Check with a multimeter if the PCB is supplied with the proper voltage (AC 102~132 V). 3. Check the wire connection. 4. Disconnect the ground wire, then check the PCB |

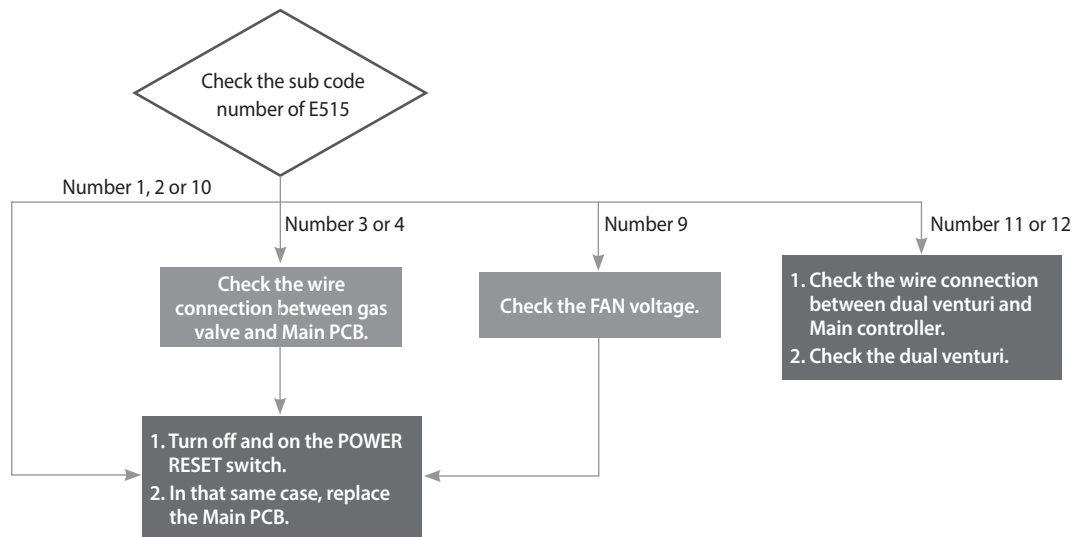

Check method

| Fault | Possible Causes | Check method |
|--------------------------|------------------------------|--|
| PCB or Electrical supply | Defective PCB | Replace the PCB if there is an error with the PCB internal circuit. |
| | Power supply error | Check with a multimeter if the PCB is supplied with the proper voltage. • Check with a multimeter if the voltage at the electrical outlet is AC 102~132 V. |
| | Power supply grounding noise | Power supply grounding noise causes malfunction. • Disconnect ground from the grounding terminal inside the unit, and check if the PCB is operating normally. |

5.1.20 517Error

Error occurrence conditions and check items

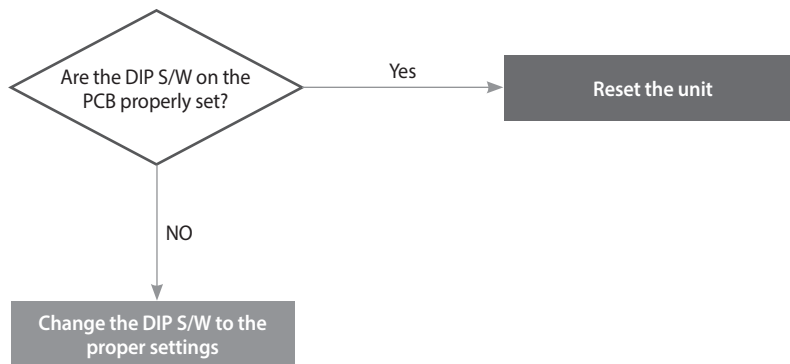

5.1.21 593Error

Error occurrence conditions and check items

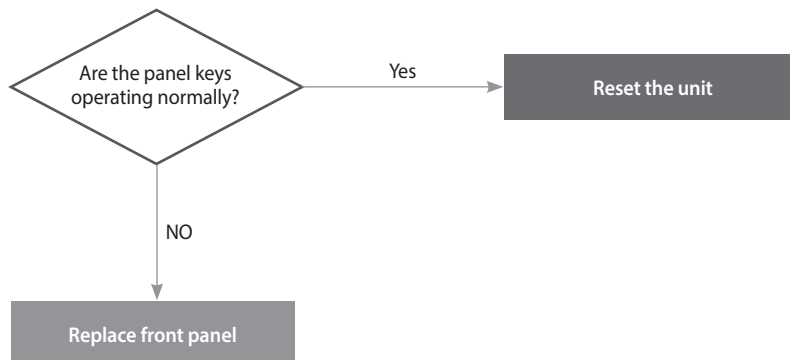

5.1.22 594Error

Error occurrence conditions and check items

| Error | Description |
|-------------|--|
| E594 error | If the communication is abnormal in parts of PCB, the system displays E594 on the PCB. |
| Check items | 1. Check the PCB. |

Check method

| Fault | Possible Causes | Check method |
|------------|--------------------------------|--|
| E594 Error | Abnormal communication by PCB. | <ol style="list-style-type: none">1. Click the Reset button on Front panel.2. Turn the POWER to the unit OFF then ON. Disconnect then reconnect power if necessary.3. If the system still displays E594, replace the main PCB. |

5.1.23 615Error

Error occurrence conditions and check items

| Error | Description |
|-------------|---|
| E615 error | Abnormal signal input by PCB. |
| Check items | <ol style="list-style-type: none">1. Turn the POWER RESET switch OFF then ON (or unplug and replug the power supply).2. If the system still displays E615, replace the main PCB. |

5.1.24 736Error

Error occurrence conditions and check items

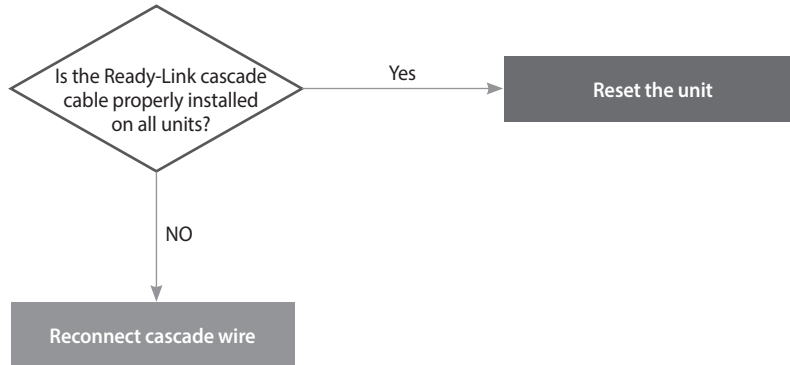

5.1.25 782Error

Error occurrence conditions and check items

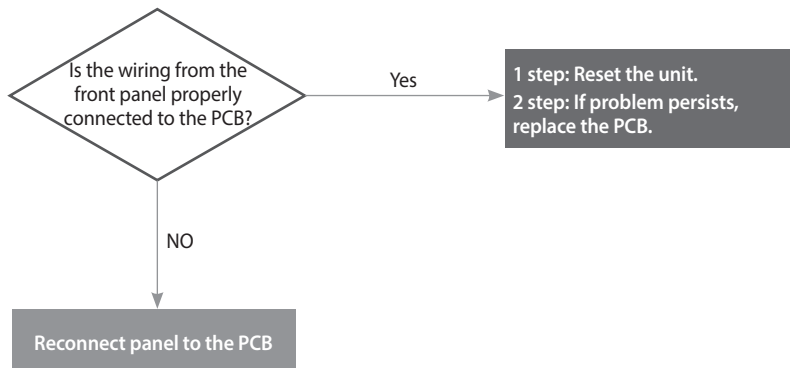

5.1.26 740Error

Error occurrence conditions and check items

| Error | Description |
|------------------------------------|--|
| E740 Abnormal outdoor sensor | If an error (under 2.2kΩ or over 122.2kΩ) in the outdoor sensor is detected continuously for 3 seconds, The system displays the error message E740 on the front panel. If this occurs, the water heater changes the control mode from Reset Curve Mode to Normal Mode. |
| Check items | <ol style="list-style-type: none">1. Check if the outdoor sensor connector is wet due to any reason, including leakage.2. Check the Resistance of the outdoor sensor.3. Check the parameter setting. (refer to page 155)4. Replace the defected Hot water outlet temperature sensor.5. Replace the controller. |

5.1.27 760Error

Error occurrence conditions and check items

| Error | Description |
|------------------------|--|
| E760 Flushing Alram | If the water heater operate more than set flushing time(day), The system displays the error message E760 on the front panel. If this occurs, the water heater operate with Normal Mode. |
| Check items | <ol style="list-style-type: none">1. Check the water heate and flushing the water heate, if it is required.2. Reset the timer with reset button on the front panel. |

5.1.28 785Error

Error occurrence conditions and check items

| Error | Description |
|--|---|
| E785 Abnormal External Flow Switch | If an AHU heating is OFF and Flow Rate is O and Flow Switch is detected continuously for 3 seconds, The system displays the error message E785. If this occurs, the water heater operate AHU heating Mode and operate DHW mode when the water heater detect saved flowrate plus 0.4 GPM (1.5 LPM) more. |
| Check items | <ol style="list-style-type: none">1. Check if the Flow Switch is ON or OFF.2. Check the Resistance of the terminal block.3. Replace the controller. |

5.2 Troubleshooting guide by symptom

5.2.1 Noise

| Error type | Cause | Check method |
|-------------------------|---|--|
| Vibration noise | Defective installation | <p>Incorrect mounting to the wall or in an improper location.</p> <ul style="list-style-type: none"> Check for improper installation and reinstall the unit if necessary. |
| | Fan vibration noise | <p>Vibration caused due to defective blower.</p> <ul style="list-style-type: none"> Check the blower. If vibration is significant, replace the fan. If intermittent noise occurs during operation, check the fan for debris. If vibration noise occurs during operation of the product, and stops when the case lid is removed, check the fan. |
| Regular noise | Defective flow sensor | Rotating noise due to debris caught in the flow sensor. |
| | Malfunction of water adjustment valve | Noise due to repeated opening/closing of water adjustment valve due to a defective PCB. |
| Noise at ignition | Gas and air differential pressure error (Pop, Beep, Explosive ignition) | <ol style="list-style-type: none"> Offset pressure adjustment error (refer to page 28) <ul style="list-style-type: none"> Adjust offset pressure with the pressure adjusting screw on the main gas valve. Set the PCB DIP 4-switch to 1-OFF,2-ON (low fire) or use the Front Panel to set the unit at "MIN.1" (refer to page 38). If noise occurs at standard value, adjust setting above/below the standard. Gas supply error due to defective air pressure sensor. If the same error is repeated, it is due to a defective PCB. |
| Noise during combustion | Boiling noise | <p>How to check boiling:</p> <ul style="list-style-type: none"> Boiling occurs if the water temperature rises to 65~75 °C (149~167 °F). The heat exchanger is clogged partially due to scale deposits. Flush the main heat exchanger to remove scale. Replace the heat exchanger if the error occurs from the start of the installation. |
| | Whirring | <p>Exhaust gas that is recirculated into the water heater through the air inlet could produce abnormal combustion noises.</p> <ul style="list-style-type: none"> Check the distance between intake and exhaust (at least 12" (300 mm)). Check the distance between flues if two or more units are installed (at least 12" (300 mm)). Check if there are any obstructions near the flue. |
| | Low gas pressure (whirring) | <ol style="list-style-type: none"> Noise occurs due to low gas pressure. <ul style="list-style-type: none"> Check the gas supply pressure (dynamic pressure) Low gas supply due to offset pressure error. (refer to page 28) <ul style="list-style-type: none"> Set the PCB DIP 4-switch to 1-OFF,2-ON (low fire) or use the Front Panel to set the unit at "MIN.1" (refer to page 38). |
| | | Noise due to defective air pressure sensor. <ul style="list-style-type: none"> Replace the air pressure sensor. |
| Noise during combustion | <ul style="list-style-type: none"> Noise due to damaged air pressure hose. Noise may be intermittent depending on the size of the damage. | |

5.2.2 Water Temperature Issue

| Error type | Cause | Check method |
|---|--|--|
| Water heater is not operating properly. | Front panel power off | Hot water does not run if the front panel is switched off. |
| | Defective flow sensor | <p>The water heater does not work due to the defective flow sensor.</p> <ul style="list-style-type: none"> The flow sensor impeller will not rotate if it contains excessive scale or debris. Clean out the flow sensor if possible. If the impeller rotates normally, replace the flow sensor back into the water heater. The sensor may be reused temporarily after cleaning, but replacement is recommended. |
| | Defective hot water temperature sensor | <p>The temperature is sensed higher than the actual temperature due to a defective hot water (cold water) sensor.</p> <ul style="list-style-type: none"> Hot water temperature is low although hot water is recognized by the water heater. The cold water temperature sensor may not work properly. |
| Low hot water temperature | Hot water setting error | Check the hot water temperature setting on the front panel. |
| | Water mixed with cold water. | <p>The temperature of hot water at the tap is low while the temperature is high at the hot water outlet.</p> <ul style="list-style-type: none"> Cold water and hot water are mixed due to improper pipe installation. Cold water and hot water are mixed due to improper piping at the hot water faucet. |
| No hot water from the valve | Check the pipe | <ol style="list-style-type: none"> The cold water valve is closed. Check if the cold water filter is clogged with foreign substance. The water adjustment valve is closed. (Refer to E434 on page 100) Check if the cold water / hot water pipes are frozen during the winter. The main heat exchanger is clogged (by scale). Low inlet water pressure |
| Cold water flows temporarily | Pre-heating does not work | For the A model, the system initiates the internal/external circulation preheating when a recirculation mode is selected on the front panel DIP switches. Confirm the DIP switch settings. |

5.2.3 Circuit breaker operation

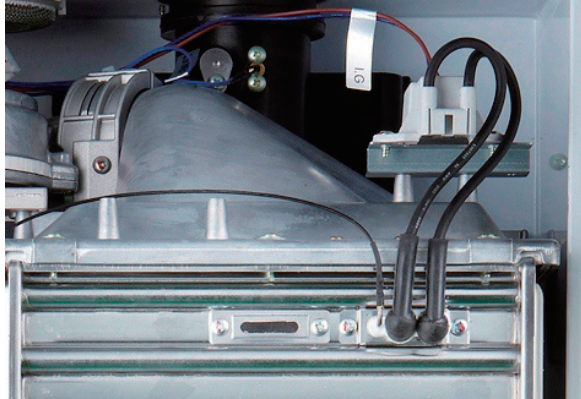
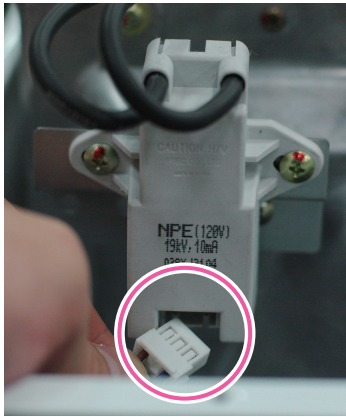
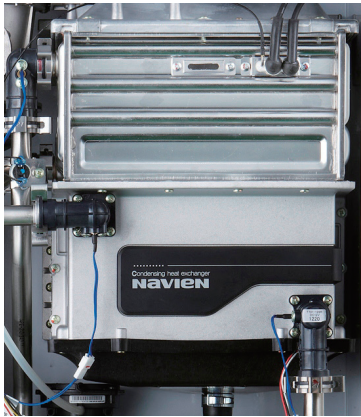
| Error type | Cause | Check method |
|-------------------------|--|--|
| Circuit breaker trips | Power supply | The circuit breaker trips immediately as soon as the power cord is plugged in the receptacle. Check the sheath of power cord, or if there is short-circuit. Check the components in order from the power transformer to the PCB. |
| | Defective part assembly | If the circuit breaker operates after repairs check the wiring of each part. Maintain proper direction when assembling the ignition transformer. Be careful that wire is not compressed when assembling the main gas valve Check if the wire is fixed and properly attached on the main side of the heat exchanger. |
| |  <p style="text-align: center;">Normal assembly</p>  <p style="text-align: center;">Short-circuit due to defective assembly</p>  <p style="text-align: center;">Wiring near the heat exchanger</p> | |
| | Circuit breaker operates while the water heater is running | If circuit breaker trips during the operation of the water heater, check the order of operation, and replace the concerned part. e.g., The circuit breaker operates at switchover to burner stage 2 after ignition. ▶ Replace the dual venturi. |
| Remote controller power | Check the wire | Check the power supply to the remote controller terminal. (DC 19 V or higher). If there is a problem in power supply, check the output voltage of the PCB, and take the action separately for wiring error and defective PCB, respectively. If the power supply is normal, replace the remote controller. |

6. Replacement of Parts

6.1 Replacement Procedure

CAUTION

1. When performing maintenance and/or servicing the water heater, always turn off the electric power, gas and water shut-off valve. Wait for the water heater to become cool. Be careful to avoid injury to your fingers on sharp edges.
2. Drain all water from the water heater when removing the waterway components.
3. Before any disassembly, make sure that all issues and error codes are properly diagnosed.
4. Handle all parts carefully.
5. When reassembling, prevent any foreign substance, i.e. dust, etc. from entering back into the water heater.
6. After reassembling, check for gas and water leakage. Then, test for proper ignition. Make sure that there is no gas leakage from the gas connections by testing with soap bubble solution. Bubbles indicate a gas leak that must be corrected.
7. Check the performance and operation after the water heater has been serviced.

To remove and replace any parts from the water heater, you will need a screwdriver that is at least 8 ~ 10 inches long. A flashlight and magnetic tip are also recommended. Navien recommends the use of a parts tray to hold small parts and screws. All of the hardware is essential to the proper operation of the unit upon re-assembly.

NOTE

When disassembling and reassembling the water heater, refer the components diagram & parts list.

6.2 Components Replacement Instructions

6.2.1 PCB

1. Turn off the gas supply to the unit.
2. Disconnect the unit from the power supply.
3. Turn off the water supply to the unit.
4. Remove the screws that are located near the top and bottom of the PCB that hold it in place as shown in Figure 1.



Figure 1

5. Disconnect all wiring connectors from the PCB as shown in Figure 2.



Figure 2

6. Remove the 2 screws located on the back of the case.

7. Remove the old PCB and replace it with the new part.
8. Reattach all wiring connectors to the PCB.
9. Set the proper DIP S/W settings on the PCB (refer to page 88).
10. Reinstall the PCB using the 2 screws previously removed.
11. Turn on the water and gas supplies, then reconnect the power supply to the unit.



NOTE

All wiring harness connections to the PCB should match in color and pintypes. Do not use excessive force when removing the connectors as this may cause damage to the PCB.

6.2.2 Fuse

1. Turn off the gas supply to the unit.
2. Disconnect the unit from the power supply.
3. Locate the fuse housing shown in **Figure 3** below. Open the housing to expose the fuse.

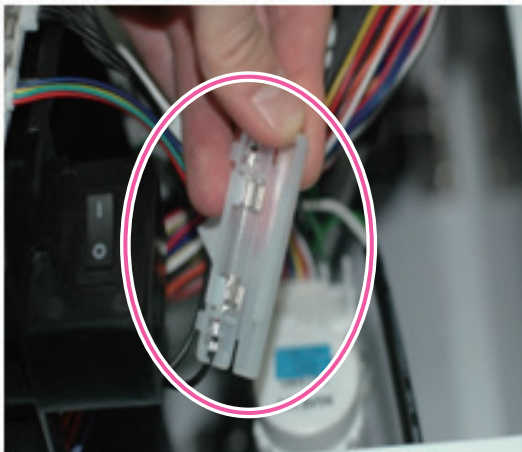

Figure 3

4. Replace the old fuse with the new part.
5. Ensure that the new fuse is of an equivalent rating and that it is properly fixed inside the housing.
6. Close the fuse housing.
7. Turn on water supply, power supply, and gas supply to the unit.

6.2.3 Fan Motor (Combustion Air)

1. Turn off the gas supply to the unit.
2. Disconnect the unit from the power supply.
3. Turn off the water supply to the unit.
4. Remove the mounting screw from the fan assembly as shown in Figure 4 below.
5. Remove the fan assembly bracket with the attached intake port.

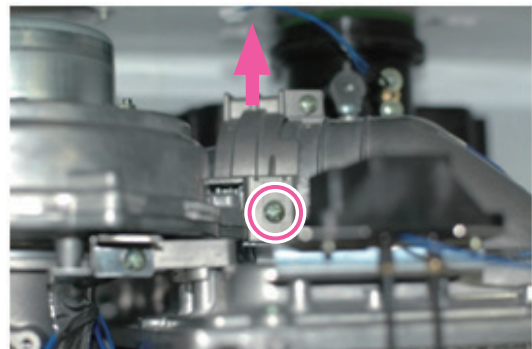

Figure 4

6. Disconnect the wiring connector from the fan assembly, and then remove the 4 screws from the gas valve connection as shown in Figure 5 below.

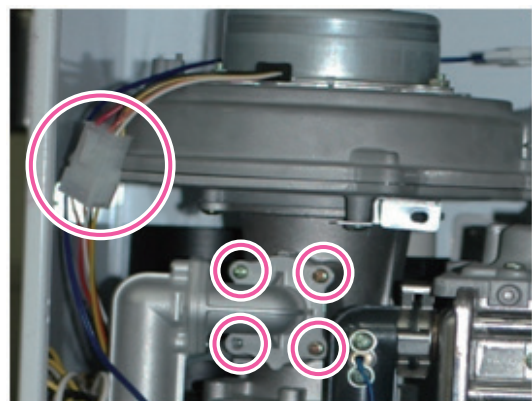

Figure 5

7. Pull out the fan assembly and remove the 4 screws that secure the air intake port to the fan assembly.

- Remove the four screws from the bottom of the fan assembly.

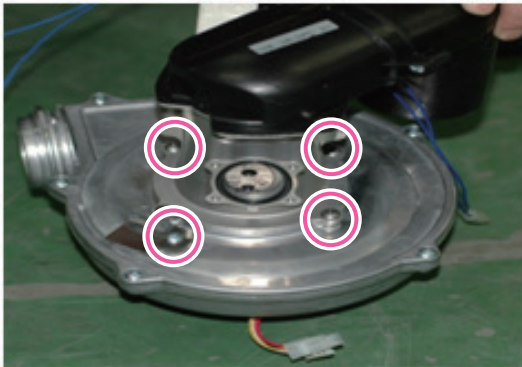

Figure 6

- Detach the fan motor from the assembly and replace it with the new part.
- Replace the 4 screws used to attach the fan motor to the assembly.
- Remove procedure of gas pipe from gas valve.
- Reinstall the fan assembly to the bracket by using the mounting screw.
- Attach the gas valve connection back to the fan assembly by using the 4 screws as shown in Figure 5.
- Reconnect the wiring connector from the fan assembly.
- Turn on water supply, power supply, and gas supply to the unit.



NOTE

Do not over-tighten the screws for the fan motor replacement with high torque drill. This may cause damage to the part(s).

6.2.4 Flame Rod

- Turn off the gas supply to the unit.
- Disconnect the unit from the power supply.
- Turn off the water supply to the unit.
- Remove the Ignition Transformer insulated cables.
- Remove the 2 screws from the flame rod as shown in Figure 7 below.

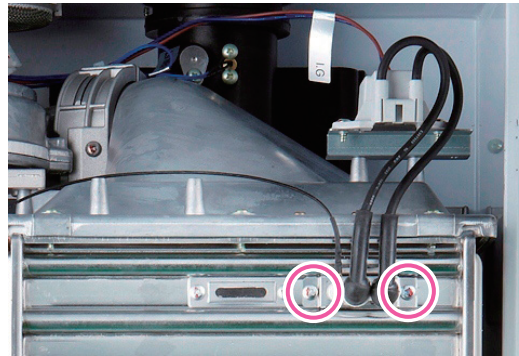

Figure 7

- Remove the flame rod wiring connector.

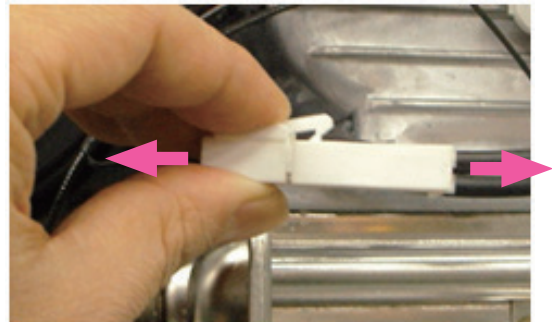

Figure 8

- Remove the flame rod from the burner assembly and replace with the new part.
- Reconnect the 2 ignition transformer insulated cables to the new flame rod.
- Place the new flame rod back onto the burner assembly and secure it by using the 2 screws from Figure 7.
- Turn on water supply, power supply, and gas supply to the unit.



NOTE

Always use new factory gaskets included with the flame rod when replacing the part onto the burner assembly.

6.2.5 Ignition Transformer

1. Turn off the gas supply to the unit.
2. Disconnect the unit from the power supply.
3. Turn off the water supply to the unit.
4. Remove the Ignition Transformer insulated cables from the flame rod.
5. Disconnect the wiring connector from the Ignition Transformer (Figure 9).

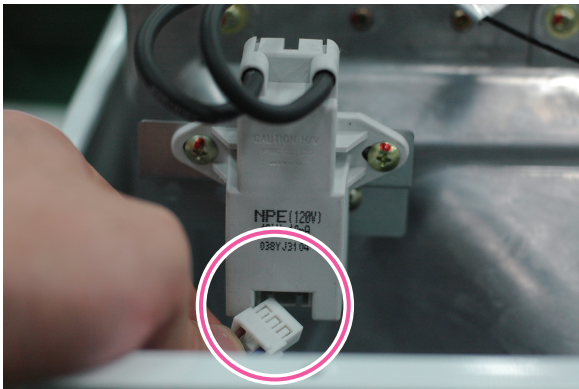

Figure 9

6. Remove the 2 screws from the Ignitor Transformer.

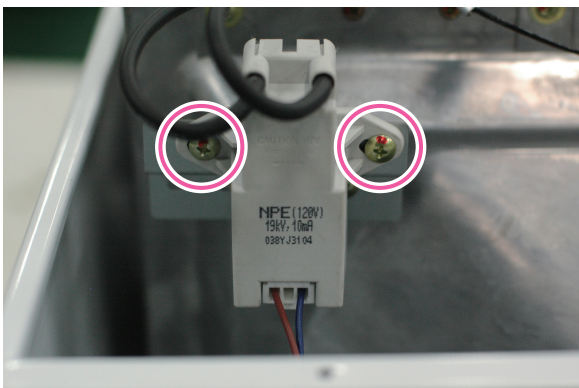

Figure 10

7. Pull out the Ignition Transformer.
8. Replace the old Ignition Transformer with the new part, and then use the 2 screws to secure the part.
9. Reconnect the Ignition Transformer insulated cables to the flame rod.
10. Reattach the wiring connectors from the Ignition Transformer.
11. Place the front panel back onto the unit and secure it by using the 4 screws.

12. Turn on water supply, power supply, and gas supply to the unit.



NOTE

Verify that the Ignition Transformer insulated cables are firmly connected to the flame rod.

6.2.6 APS

1. Turn off the gas supply to the unit.
2. Disconnect the unit from the power supply.
3. Turn off the water supply to the unit.
4. Remove the air pressure sensor wiring connector (Figure 11).



Figure 11

5. Remove the hose from the air pressure sensor.

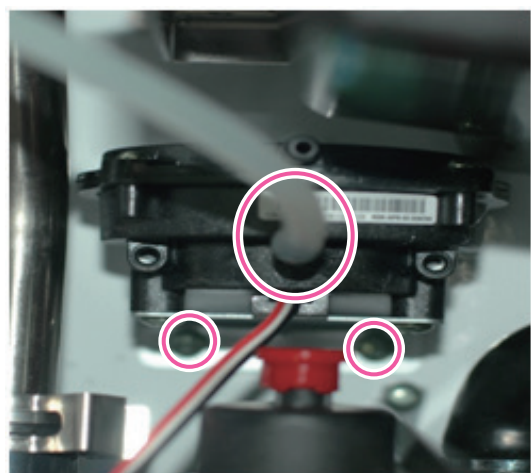

Figure 12

6. Remove the 2 screws that attaches the air pressure sensor to the burner assembly.
7. Pull out the air pressure sensor.
8. Replace the old air pressure sensor with the new part.
9. Reattach the air pressure sensor hose.
10. Connect the air pressure sensor wiring connector.
11. Place the front panel back onto the unit and secure it using the 4 screws.
12. Turn on water supply, power supply, and gas supply to the unit.



NOTE

Confirm that the new air pressure sensor is in the proper position before turning the unit back on.

6.2.7 Main Gas Valve

1. Turn off the gas supply to the unit.
2. Disconnect the unit from the power supply.
3. Turn off the water supply to the unit.
4. Remove the 2 screws.
5. Disconnect the wiring connector at the gas valve.

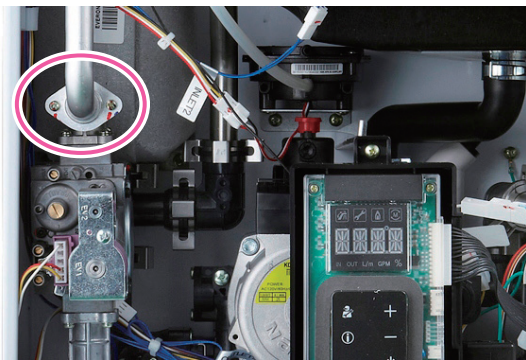
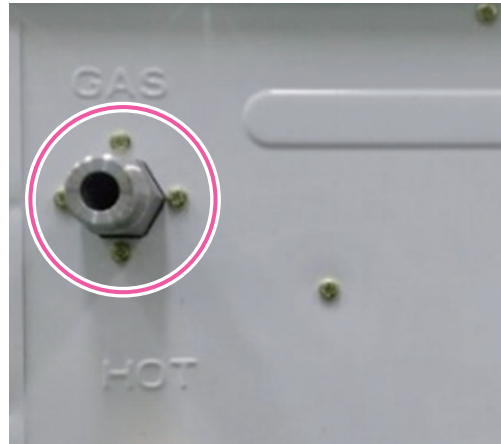

Figure 13

6. Remove the 4 screws located at the bottom of the unit that are attached to the gas valve.



7. Remove the 4 screws directly on the bottom of the gas valve to remove the gas pipe.

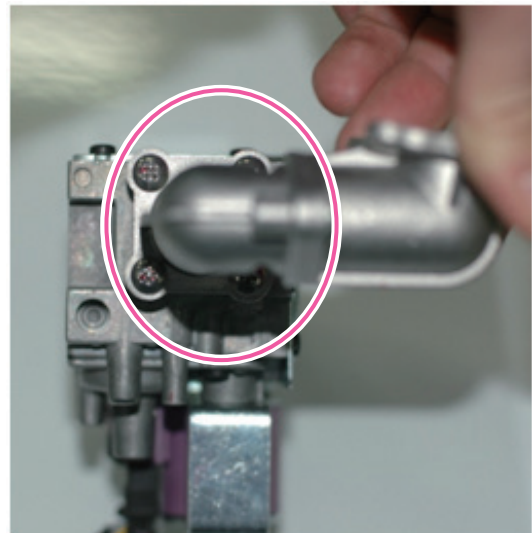

Figure 14



Figure 15

8. Remove the 4 screws directly from the bottom of the gas valve to remove the elbow.
9. Replace the O-ring where the gas valve assembly attaches to the elbow. Make sure the old O-ring is discarded.
10. Replace the old gas valve with the new part and reattach the elbow and gas pipe to the gas valve.
11. Reconnect the gas valve assembly to the unit by using the 4 screws at the elbow and 2 screws at the gas pipe.
12. Reattach the gas valve wiring connector.



WARNING

Failure to correctly assemble the components according to these instructions may result in a gas leak or explosion.

13. Check that all gas connections are tightly sealed to ensure that no gas leaks are present.
14. Turn on water supply, power supply, and gas supply to the unit.
15. Verify the gas pressures to the unit with the values provided in this Service Manual.



NOTE

Always replace the old O-rings and gaskets with new parts to ensure tight seals between connections. Ensure that all properly sized O-rings are used for the replacement.

6.2.8 Condensate Trap

1. Turn off the gas supply to the unit.
2. Disconnect the unit from the power supply.
3. Turn off the water supply to the unit.
4. Remove the pin that secures the condensate drain cap and then remove the cap. Use a bucket to collect the condensate.



Figure 16

5. Detach the condensate piping from the unit.
6. Remove the 3 screws located at the bottom of the unit that are attached to the condensate trap.



Figure 17

- Loosen the clip that secures the hose to the condensate trap, and then pull off the hose.

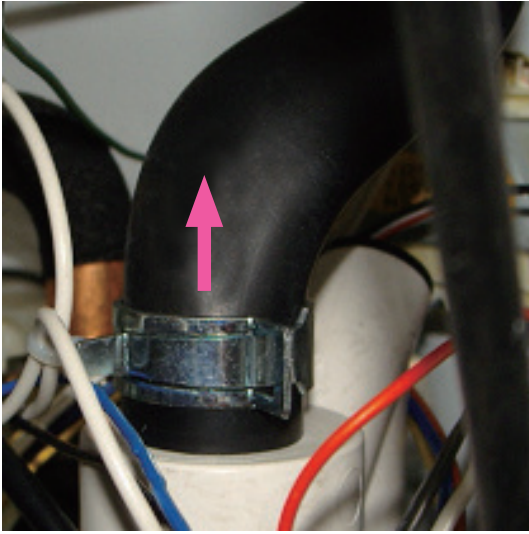

Figure 18

- Remove the old condensation trap and replace it with the new part.
- Reconnect the hose to the condensate trap.
- Reattach the condensation trap to the unit and secure it using the 5 screws.
- Replace the controller to its original position.
- Turn on the water supply, power supply, and gas supply to the unit.



NOTE

Ensure that the condensate drain trap is completely inserted into the condensate fitting to eliminate leaking. Use the pin to secure the cap to the fitting.

6.2.9 Flow Sensor

- Turn off the gas supply to the unit.
- Disconnect the unit from the power supply.
- Turn off the water supply to the unit. Drain all water from the appliance.
- Remove the stainless clip and four screws at the flow sensor.

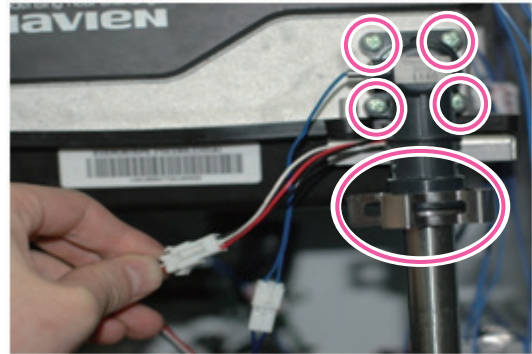

Figure 19

- Detach the 2 wire connectors that connect the flow sensor to the PCB.

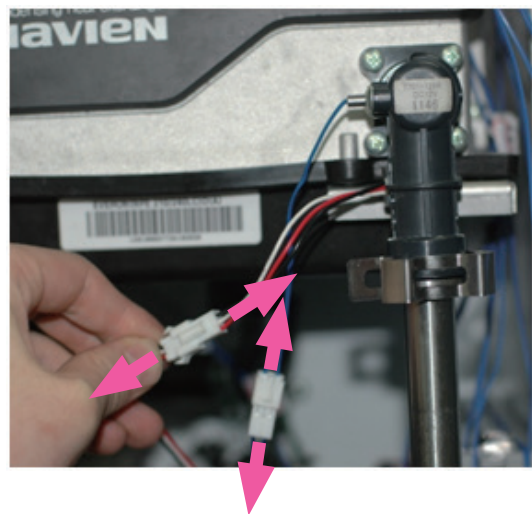

Figure 20

- Pull out the flow sensor.
- Replace with old flow sensor with the new part.

8. Reinstall the flow sensor into the cold water inlet pipe and reattach the stainless clip. Ensure that the flow sensor is properly connected to the cold water inlet pipe and that the clip is tightly holding the two parts together.
9. Reinstall the four screws at the flow sensor to secure the part to the heat exchanger.
10. Turn on water supply, power supply, and gas supply to the unit.
11. Carefully open a hot water tap and ensure there are no leaks at the flow sensor connections.

6.2.10 Buffer Tank

1. Turn off the gas supply to the unit.
2. Disconnect the unit from the power supply.
3. Turn off the water supply to the unit. Drain all water from the appliance.
4. Remove the gas valve to gain access to the buffer tank (refer to the gas valve replacement procedures).

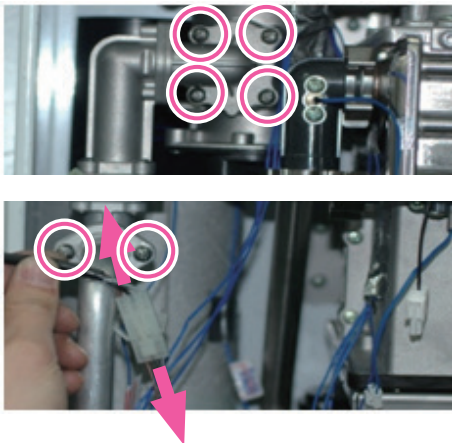

Figure 21

5. Remove the clip at the bottom of the buffer tank.

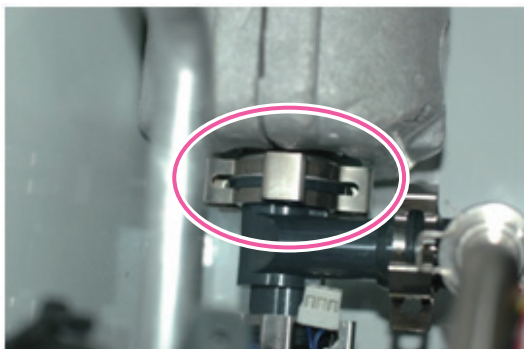

Figure 22

6. Remove the 3 mounting screws from the buffer tank.

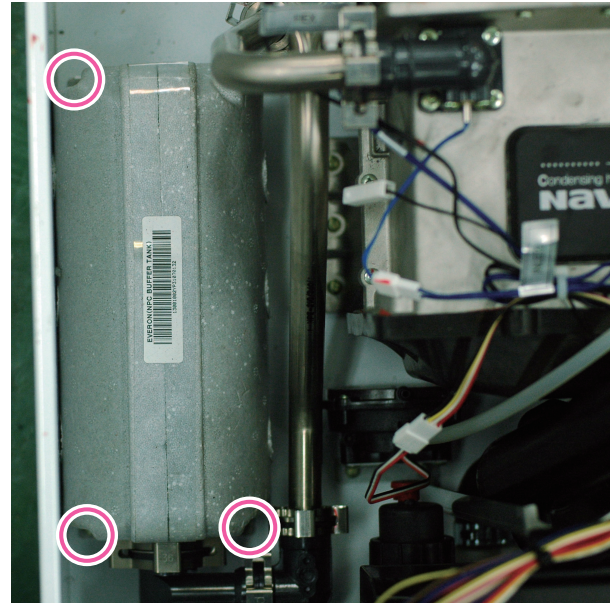

Figure 23

7. Pull out the buffer tank.
8. Replace the old buffer tank with the new part.
9. Reinstall the buffer tank by using the 4 mounting screws.
10. Attach the gas valve assembly back onto the unit (refer to the gas valve replacement procedures).
11. Turn on water supply, power supply, and gas supply to the unit.
12. Carefully open a hot water tap and ensure there are no leaks at the buffer tank connections.

NOTE

1. Use caution when removing the buffer tank from the unit as it may contain scalding hot water.
2. Use properly sized O-rings at the buffer tank connections.
3. Protect the electrical components as contact with excess water could cause damage.

6.2.11 Circulation Pump

1. Turn off the gas supply to the unit.
2. Disconnect the unit from the power supply.
3. Turn off the water supply to the unit. Drain all water from the appliance.
4. Remove the 3 screws from the bottom of the case along with the screw that connects the rear bracket to the case in order to detach the front panel from the unit.

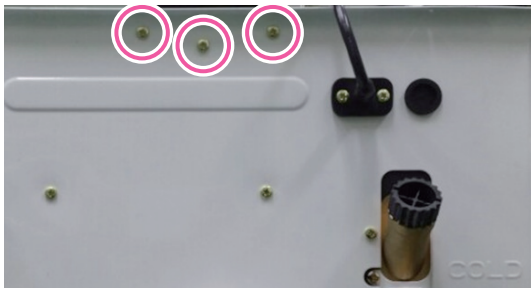

Figure 24

5. Move the controller aside for better access to the Circulation Pump.
6. Remove the 2 screws from the bottom of the case.

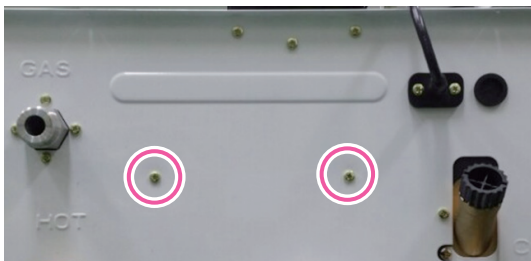

Figure 25

7. Unscrew the pump drain plug.

8. Remove the stainless steel clip and 2 screws from the pump as shown in Figure 26.

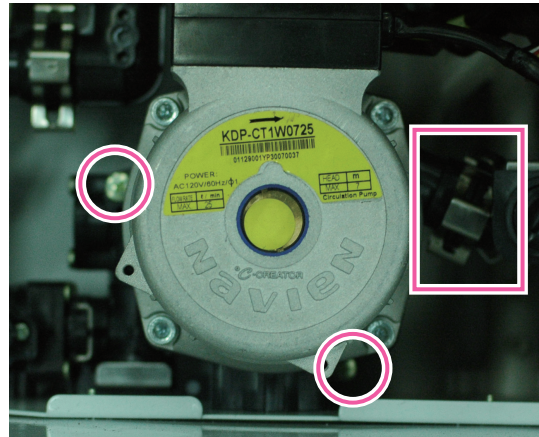

Figure 26

9. Disconnect the wiring connector at the pump assembly.

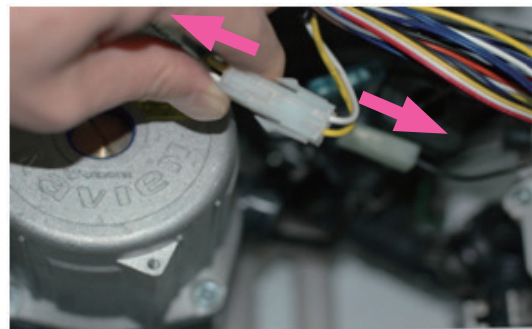

Figure 27

10. Carefully remove the pump.



Figure 28

11. Replace with the new pump.
12. Place the new pump back into its original position and ensure that all connections are tightly sealed.
13. Secure the pump with the stainless steel clip and the 2 fixing screws.
14. Reinstall the pump drain plug at the bottom of the unit.
15. Reconnect the wiring connector at the pump.
16. Attach the controller back onto the unit by using the 3 screws at the bottom of the unit.
17. Fix the pump bracket to the case with the mounting screw.
18. Use the 4 screws at the bottom of the case to fix the pump to the unit.
19. Install front panel using 4 screws.
20. Turn on water supply, power supply, and gas supply to the unit.
21. Open a hot water tap and ensure that there are no leaks at the pump connections.
22. Open the air vent on top of pump to release air within the system.



NOTE

Always use proper O-rings at the pump connection to ensure tight seals

6.2.12 2-Way Valve

1. Turn off the gas supply to the unit.
2. Turn off the 120V power supply to the unit.
3. Turn off the water supply to the unit. Drain all water from the appliance.
4. Remove the 3 screws at the hot water outlet fitting to loosen the 2-way valve that is attached to the hot water outlet fitting.

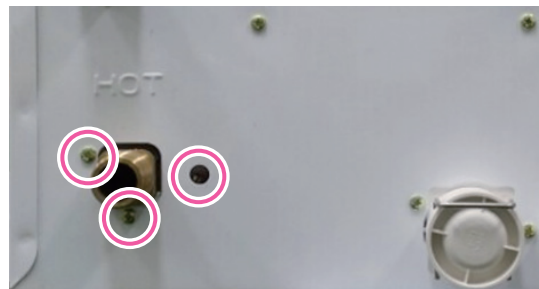

Figure 29

5. Remove the 4 stainless steel clips from the connections (2 round clips and 2 flat clips).

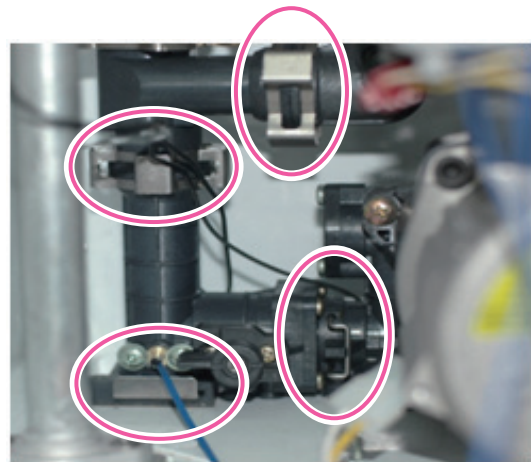

Figure 30

6. Disconnect the wiring connector at the 2-way valve.

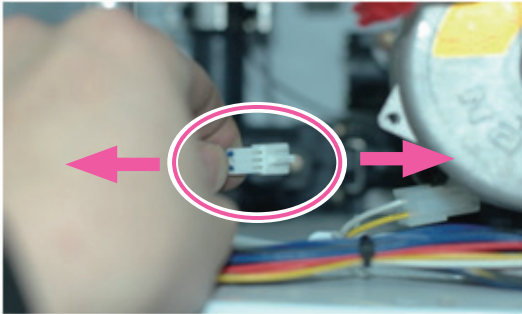

Figure 31

7. Remove the 3 buffer tank screws and pull out the buffer tank

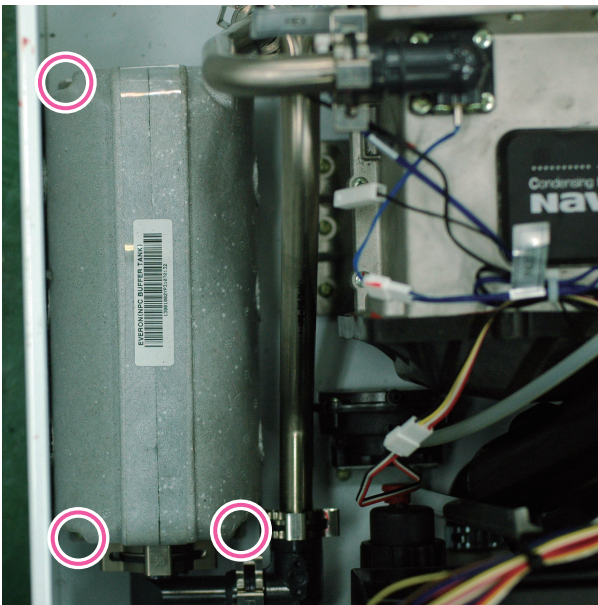

Figure 32

8. Replace with new 2-way valve.
9. Place the 2 round stainless steel clips and 2 flat stainless clips back onto the 2-way valve connections.
10. Replace the 4 buffer tank mounting screws.
11. Reconnect the wiring connector at the 2-way valve.
12. Place the front panel back onto the unit using 4 screws.
13. Turn on water supply, power supply, and gas supply to the unit.
14. Open a hot water tap and ensure there are no leaks at the water heater.

6.2.13 Water Adjustment Valve

1. Turn off the gas supply to the unit.
2. Disconnect the unit from the power supply.
3. Turn off the water supply to the unit. Drain all water from the appliance.
4. Disconnect the mixing valve wire connector.

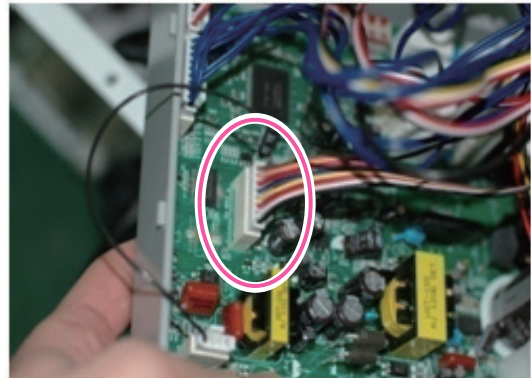

Figure 33

5. Remove the 2 stainless steel clips from the water adjustment valve connections.

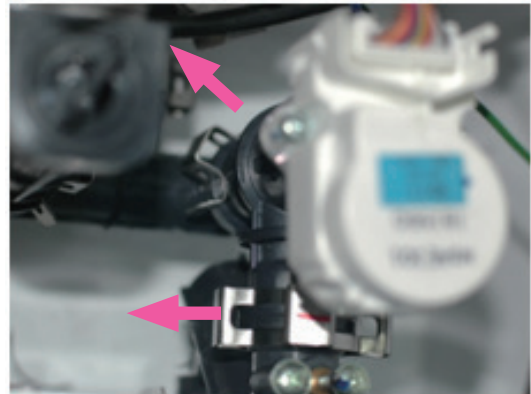
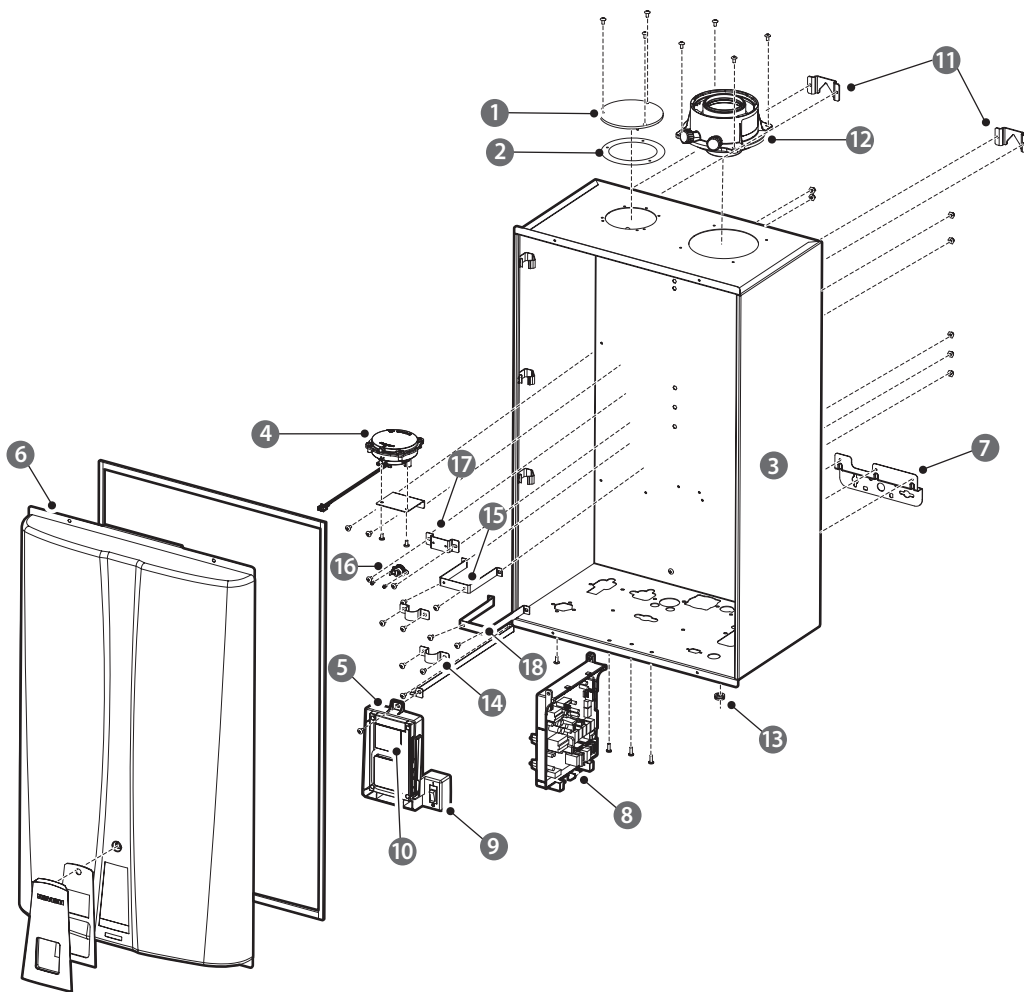

Figure 34

6. Remove the water adjustment valve.
7. Replace with the new water adjustment valve.
8. Place the 2 stainless steel clips back onto the valve connections. Ensure that the clips are securely holding the connection together to prevent leaks.
9. Reattach the water adjustment valve wire connectors.
10. Turn on water supply, power supply, and gas supply to the unit.
11. Open a hot water tap and ensure there are no leaks at water adjustment valve connections.

7. Components Diagram and Part List

7.1 Case Assembly



| # | Description | Model | # | Description | Model |
|---|-----------------------|-------|----|---------------------------------|-----------------|
| 1 | Air Intake Cover | | 10 | Front Panel | |
| 2 | Air Intake Cover Seal | | 11 | Case Bracket | |
| 3 | Case | | 12 | Coaxial Adapter | |
| 4 | Air Pressure Sensor | | 13 | Rubber Ring | |
| 5 | Panel Bracket | | 14 | Saddle | NPE-24SWE/32SWE |
| 6 | Cover | | 15 | Saddle Bracket 1 | NPE-24SWE/32SWE |
| 7 | Case Lower Bracket | | 16 | Freeze Protector Sensor | NPE-24SWE/32SWE |
| 8 | PCB | | 17 | Freeze Protector Sensor Bracket | NPE-24SWE/32SWE |
| 9 | Power Switch | | 18 | Saddle Bracket 2 | NPE-24SWE/32SWE |

7.2 Burner Assembly (NPE-24AWE/32AWE)

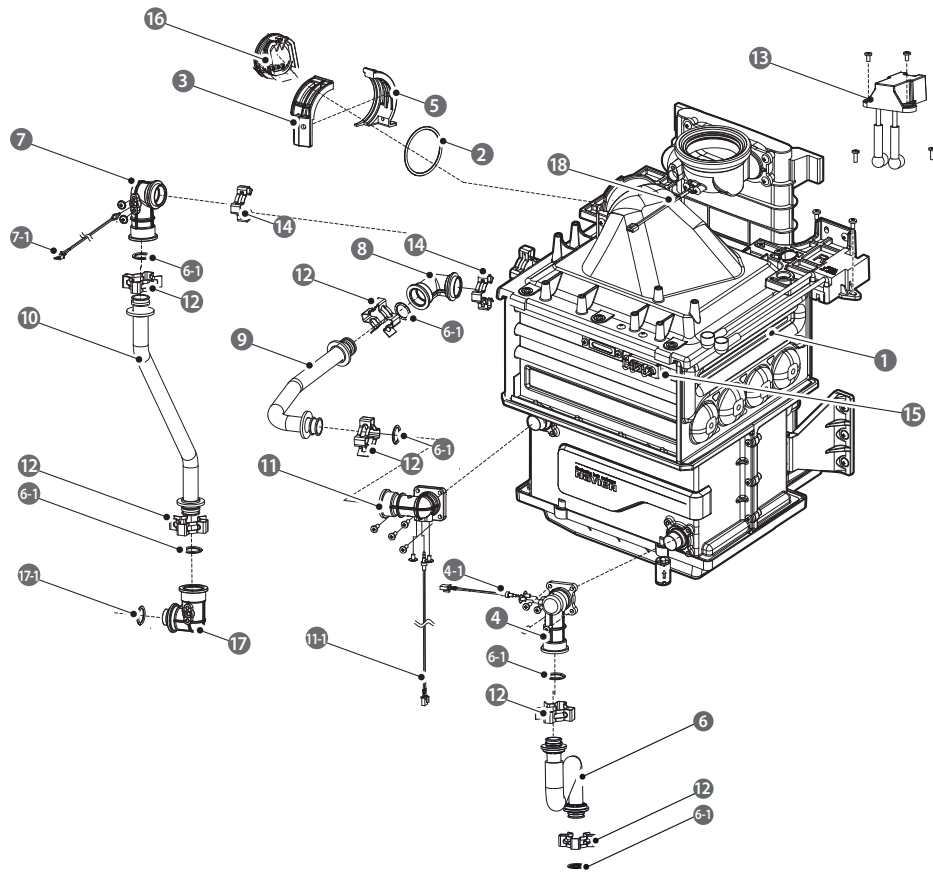

| # | Description | Model | # | Description | Model |
|-----|-------------------------|------------------------|------|---------------------------|------------------------|
| 1 | Heat Exchanger Assembly | NPE-24AWE NPE-32AWE | 10 | Hot Water Outlet Pipe | NPE-24AWE NPE-32AWE |
| 2 | Fan O-Ring (G50) | | 11 | WPA-A (Screw) | |
| 3 | Fan Bracket(F) | | 11-1 | Thermistor | |
| 4 | Flow Sensor Assembly | | 12 | Fastner | |
| 5 | Fan Bracket(R) | | 13 | Ignition Transformer | |
| 6 | Cold Inlet Pipe | NPE-24AWE NPE-32AWE | 14 | Fastner | |
| 6-1 | O-Ring (Φ17.5x2.7t) | | 15 | Ignitor | |
| 7 | WPA-A (Clip) | | 16 | Damper | |
| 7-1 | Thermistor | | 17 | Buffer Tank Inlet Adapter | |
| 8 | WPA-B | | 17-1 | O-Ring (P16) | |
| 9 | H-Ex Middle Pipe | NPE-24AWE NPE-32AWE | 18 | Thermistor | |

7.3 Burner Assembly (NPE-24SWE/32SWE)

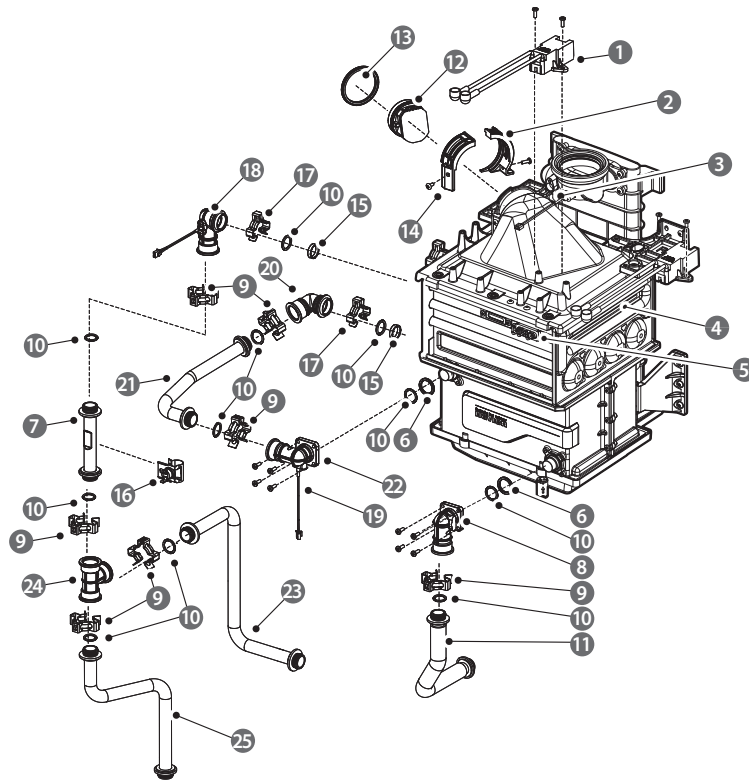

| # | Description | Model | # | Description | Model |
|----|----------------------------|-----------|----|-----------------------|-----------------|
| 1 | Ignition Transformer | | 14 | Fan Bracket (F) | |
| 2 | Fan Bracket (R) | | 15 | Backup Ring | |
| 3 | Thermistor | Exhaust | 16 | High Limit Switch | |
| 4 | Heat Exchanger Assembly | NPE-24SWE | 17 | Fastner | |
| | | NPE-32SWE | 18 | WPA-A (Clip) | |
| 5 | Ignitor | | 19 | Thermistor | Water |
| 6 | Packing (Φ26.5x2.4t) | | 20 | WPA-B | |
| 7 | Heat Exchanger Outlet Pipe | NPE-24SWE | 21 | H-Ex Middle Pipe | NPE-24SWE/24AWE |
| | | NPE-32SWE | | | NPE-32SWE/32AWE |
| 8 | WPA-C (Screw) | | 22 | WPA-A (Screw) | |
| 9 | Fastner | | 23 | Mixing Pipe | NPE-24SWE |
| 10 | O-Ring (Φ17.5x2.7t) | | | | NPE-32SWE |
| 11 | Cold Inlet Pipe | NPE-24SWE | 24 | WPA-T | |
| | | NPE-32SWE | | | |
| 12 | Fan Damper | | 25 | Hot Water Outlet Pipe | NPE-24SWE |
| 13 | Fan Packing | | | | NPE-32SWE |

7.4 Waterway Assembly (NPE-24AWE/32AWE)

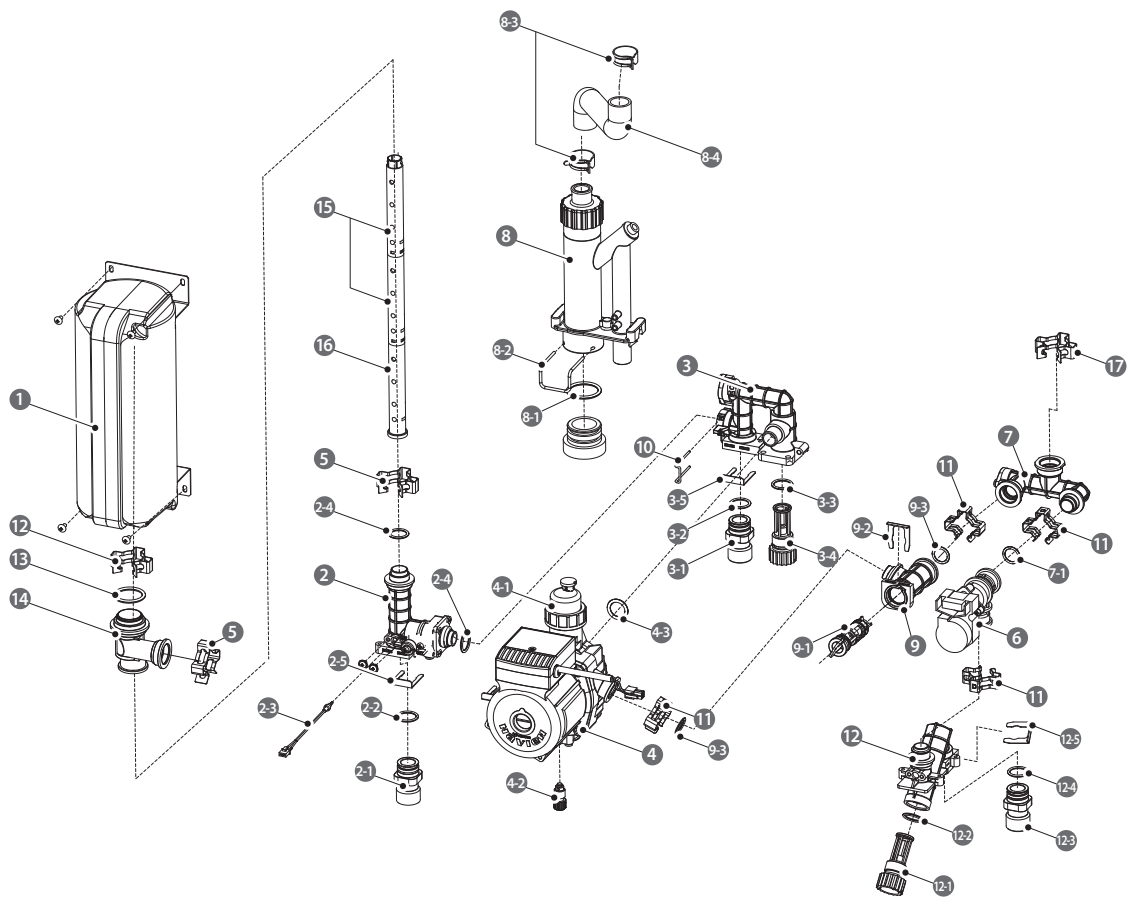

| # | Description | Model | # | Description | Model | # | Description | Model |
|-----|--------------------------------|-------|-----|------------------------------|-------|------|--------------------------------|-------|
| 1 | Buffer Tank | | 4-2 | Drain Plug | | 9-3 | O-Ring (P16) | |
| 2 | Hot Water Outlet Pipe Assembly | | 4-3 | O-RING (P18) | | 10 | Return Pipe clip | |
| 2-1 | Pipe Adapter | | 5 | Fastner | | 11 | Fastner | |
| 2-2 | O-RING (P20) | | 6 | Water Adjustment Valve (WAV) | | 12 | Cold Water Inlet Pipe Assembly | |
| 2-3 | Thermistor (Red) | | 7 | WAV Outlet Pipe Assembly | | 12-1 | Water Filter | |
| 2-4 | O-RING (P16) | | 7-1 | O-Ring (P16) | | 12-2 | O-RING (P19) | |
| 2-5 | Pipe Clip | | 8 | Syphon | | 12-3 | Pipe adapter | |
| 3 | Return Pipe Assembly | | 8-1 | O-Ring (Φ31.7x3.5t) | | 12-4 | O-RING (P20) | |
| 3-1 | Pipe adapter | | 8-2 | Syphon Clip | | 12-5 | Pipe Clip | |
| 3-2 | O-RING (P20) | | 8-3 | Hose Clip | | 13 | O-RING (P29) | |
| 3-3 | O-RING (P19) | | 8-4 | Syphon Hose | | 14 | Buffer Tank Adapter | |
| 3-4 | Water Filter | | 9 | Pump Outlet Pipe Assembly | | 15 | Buffer Tank Pipe A | |
| 3-5 | Pipe Clip | | 9-1 | Check Valve | | 16 | Buffer Tank Pipe B | |
| 4 | Circulation Pump | | 9-2 | Pipe Clip | | 17 | Fastner | |
| 4-1 | Pump Air Separator | | | | | | | |

7.5 Waterway Assembly (NPE-24SWE/32SWE)

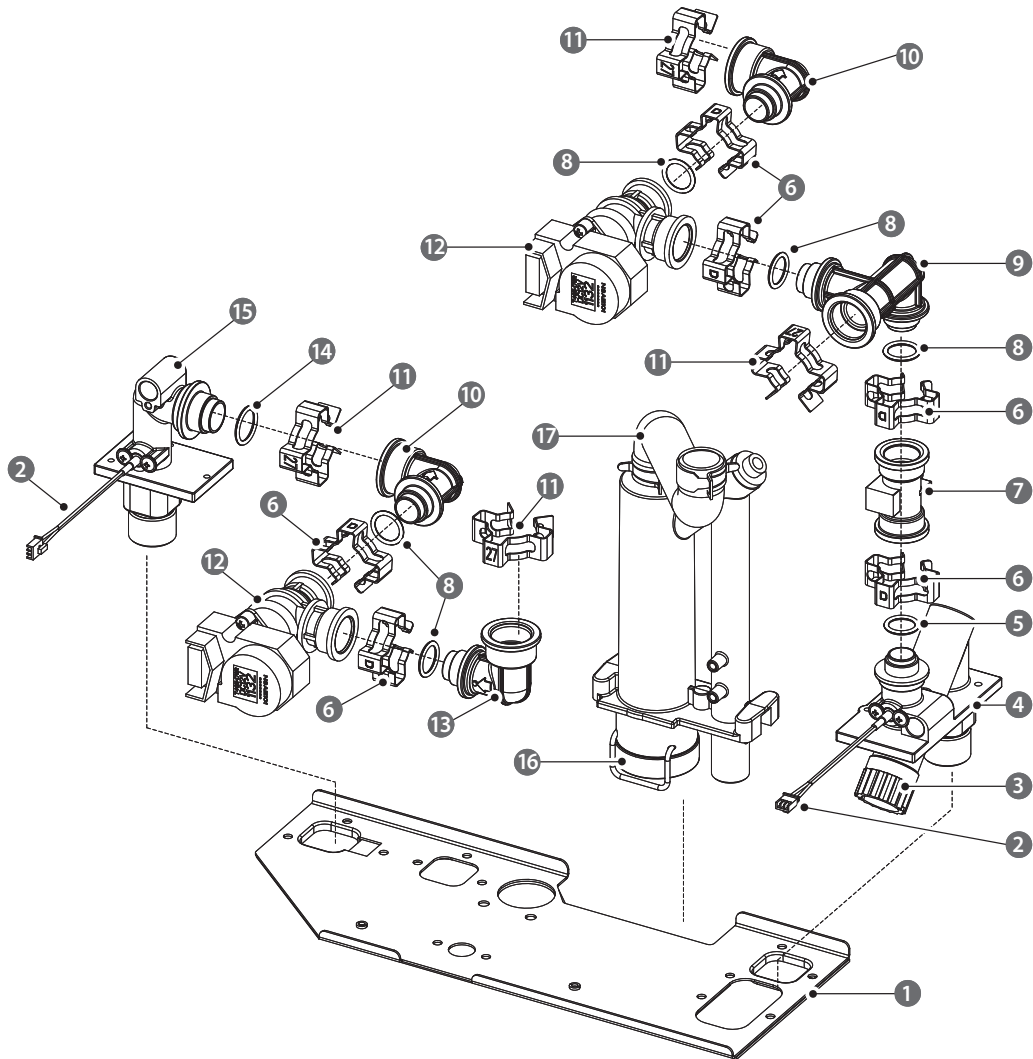

| # | Description | Model | # | Description | Model |
|---|----------------------------|-------|----|------------------------------|-------|
| 1 | Bracket | | 10 | Outlet Adapter | |
| 2 | Thermistor | | 11 | Fastner | |
| 3 | Water Filter | | 12 | Water Adjustment Valve (WAV) | |
| 4 | Cold Water Inlet Adapter | | 13 | Inlet Adapter | |
| 5 | O-Ring (P15) | | 14 | O-Ring (P18) | |
| 6 | Fastner | | 15 | How Water Outlet Adapter | |
| 7 | Flow Sensor | | 16 | Siphon | |
| 8 | O-Ring (P16) | | 17 | Siphon Hose | |
| 9 | Flow Sensor Outlet Adapter | | | | |

7.6 Fan(Gas) Assembly

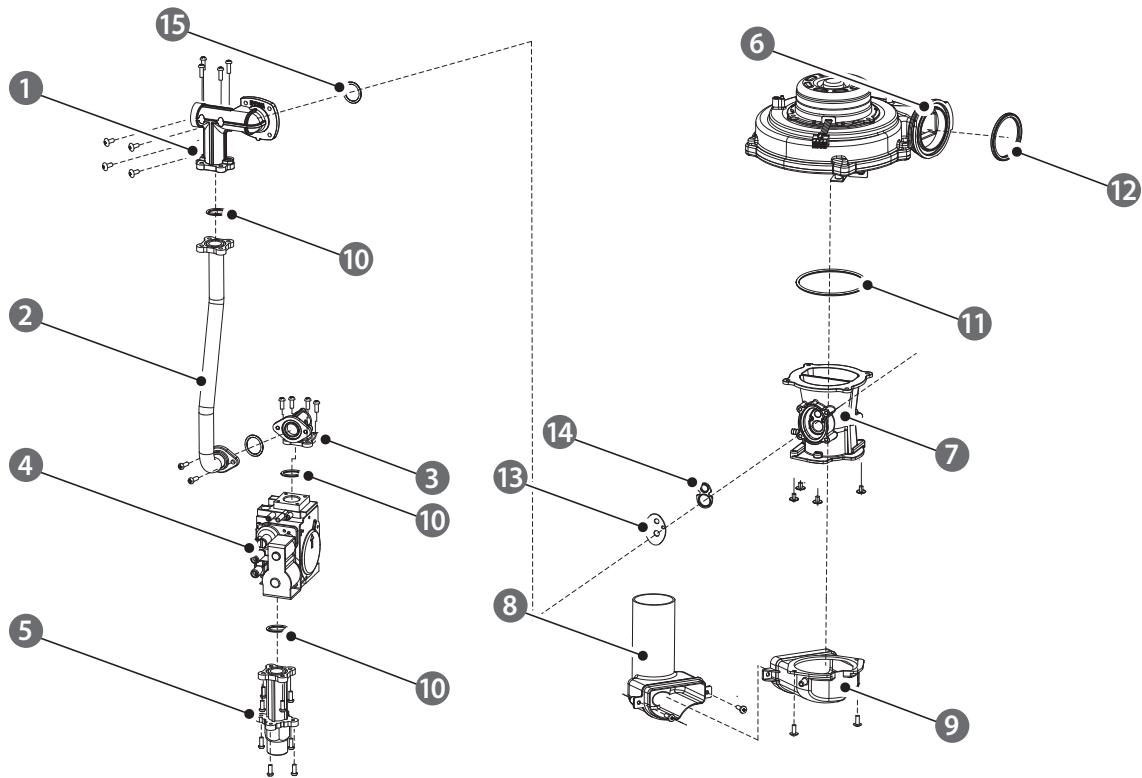

| # | Description | Model | # | Description | Model |
|---|-------------------|-----------------|----|-----------------|-----------------|
| 1 | Gas Adapter | NPE-24AWE/24SWE | 9 | Silence Adapter | NPE-24AWE/24SWE |
| | | NPE-32AWE/32SWE | | | NPE-32AWE/32SWE |
| 2 | Gas Pipe | NPE-24AWE/24SWE | 10 | O-Ring (P20) | |
| | | NPE-32AWE/32SWE | 11 | O-Ring (G75) | |
| 3 | Gas Connector | | 12 | Fan Packing | |
| 4 | Gas Valve | | 13 | Gas Orifice | NPE-24AWE/24SWE |
| 5 | Gas Inlet Adapter | | | | NPE-32AWE/32SWE |
| 6 | Fan Assembly | | 14 | Venturi packing | |
| 7 | Dual Venturi | NPE-24AWE/24SWE | 15 | O-Ring (P34) | |
| | | NPE-32AWE/32SWE | | | |
| 8 | Silence | NPE-24AWE/24SWE | | | |
| | | NPE-32AWE/32SWE | | | |

8. Inspection and Maintenance Schedule

8.1 Maintenance

This section describes various maintenance procedures that may need to be performed on the water heater from time to time.

8.1.1 Cleaning the Water Heater

CAUTION

Make sure the water heater is turned off and the power supply is disconnected before cleaning the water heater. The water heater may remain hot for several minutes after it is turned off. To prevent burns, wait until the water heater has cooled down before cleaning.

To clean the water heater, wipe the outside with a damp cloth. Use a non-acidic, non-abrasive cleaner to remove any surface stains. The front panel is moisture resistant, but it is not waterproof. Keep it as dry as possible.

8.1.2 Draining the Water Heater

You need to drain the water heater before performing maintenance tasks, such as cleaning the inlet water filter, or to prevent the water heater from freezing when it will not be used for an extended period.

To drain the water heater:

1. Place a bucket under the water heater, to collect the residual water inside the water heater.
2. Press the Power button on the front panel to turn off the power to the water heater.

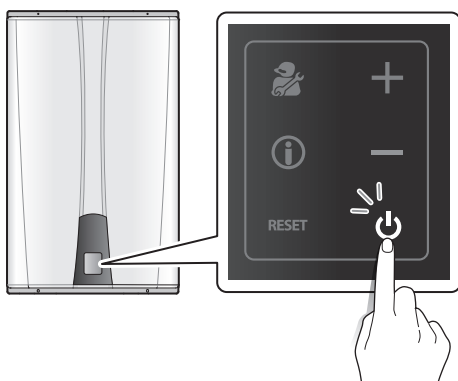

3. Close the gas valve.

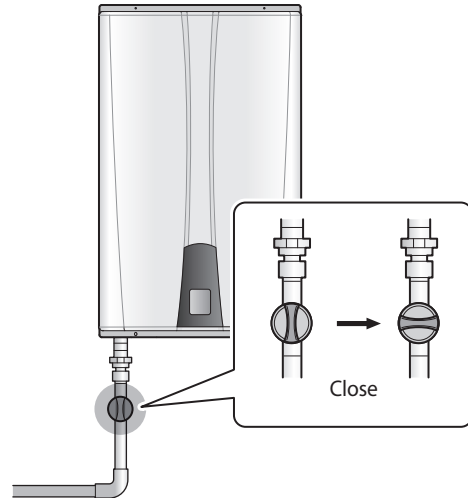

4. Close the water supply valve on the inlet to the water heater. If there is no valve, turn off the water supply at the water main.

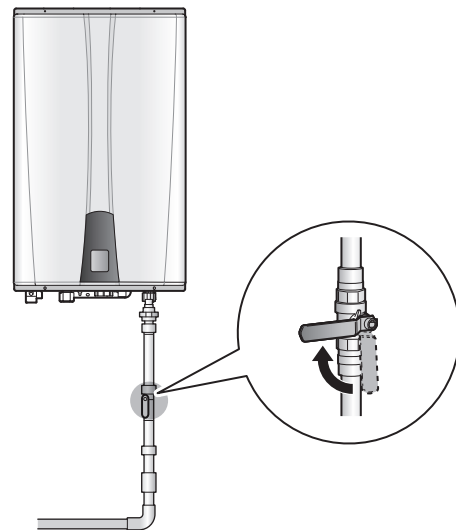

5. Open all hot water faucets completely. The water that remains in the plumbing lines will drain out.

- Remove the pump inlet filter from the bottom of the water heater.

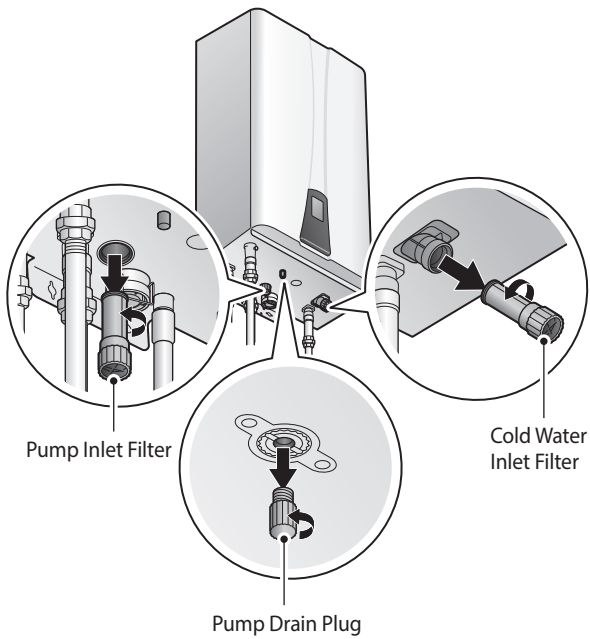

- Open the pump drain plug.
- Remove the cold water inlet filter.
- Allow the residual water to drain from the water heater.
- When the water is completely drained, reinsert the pump inlet filter and the cold water inlet filter, and then close the pump drain plug.
- To refill the water heater follow the steps of "Draining the Water Heater" in reverse.

Draining the water in the condensate trap

Referring to the below figures, place a bucket under the water heater and remove the cap from the bottom of the trap to drain collected condensate.

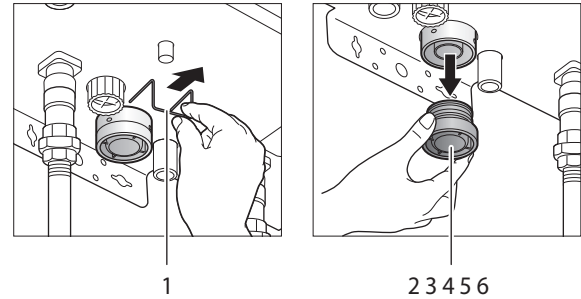

| # | Description |
|---|--|
| 1 | Remove the retaining clip. |
| 2 | Place a bucket under the water heater. |
| 3 | Twist and remove the cap. |
| 4 | Clean out the condensate trap. |
| 5 | Replace the cap and the retaining clip. |
| 6 | Pour water down the exhaust flue (if possible) or allow the unit to run to refill the condensate trap. |

8.1.3 Flushing the Heat Exchanger

! CAUTION

Flushing the Heat Exchanger shall be performed only by an authorized technician or licensed professional. Read the following instructions carefully before attempting this procedure. Keep in mind that improper maintenance can void your warranty.

Before flushing the Heat Exchanger, gather the following items:

- A bucket that is 5 gallons or larger
- Cleaning solution diluted with water
- 3 hoses
- A submersible circulation

To flush the Heat Exchanger:

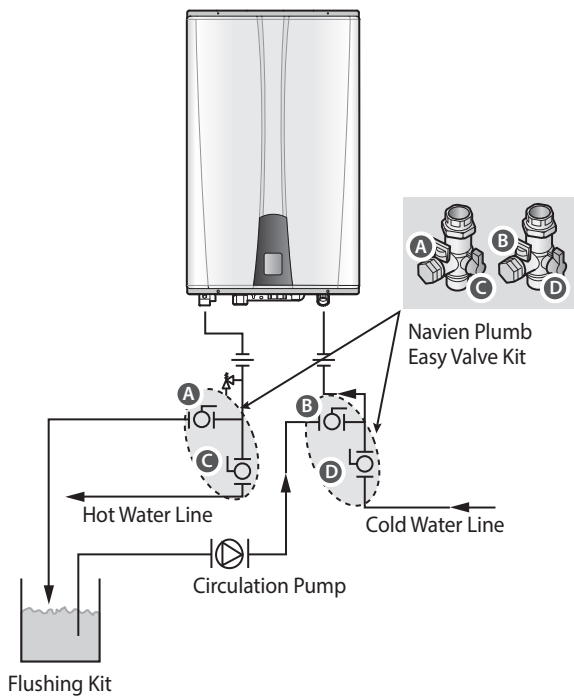

1. Press the Power button on the front panel to turn off the water heater.
2. Disconnect the power supply to the water heater.
3. Close the "C" and "D" valves on the hot and cold water lines.
4. Connect one tube to the "A" valve and place the free end in the bucket.
5. Connect one of the tubes to the circulation pump outlet and the cold water line at the "B" valve.
6. Connect one tube to the circulation pump inlet and place the free end in the bucket.
7. Pour the cleaning solution into the bucket.
8. Open both "A" and "B" valves.
9. Turn on the circulation pump and allow the solution to circulate through the water heater for at least 45 minutes.
10. Rinse the cleaning solution from the water heater:
 - a. Remove the free end of the drain tube from the bucket and place it in the condensate drain or laundry tub (wherever the water heater drains).
 - b. Close the "B" valve and open the "D" valve. Do not open the "C" valve yet.
 - c. Allow water to flow through the water heater for 5 minutes.
 - d. Close the "A" valve and open the "C" valve.
11. Disconnect all tubes.
12. Remove the cold water inlet filter from the water heater and clean out any residue.
13. Reinsert the filter and ensure the filter cap is securely tightened.
14. Reconnect the power supply to the Water Heater.
15. Press the Power button on the front panel to turn on the water heater.

8.1.4 Cleaning the Inlet Water Filter and Recirculation Inlet Filter

To clean the filters:

1. Drain the water heater.
2. While the filters are removed, rinse it with clean running water (cold) and, if necessary, scrub it clean with a brush.

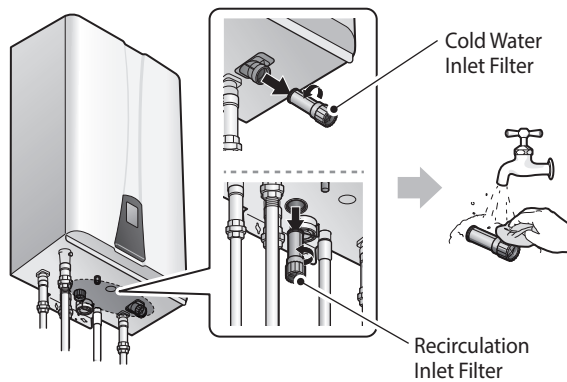

3. Reinsert and tighten the filters.

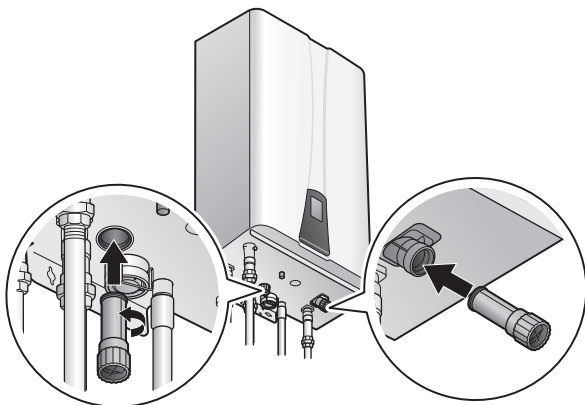

4. Refill the water heater.

8.2 Annual Servicing

In order to maintain its safe and efficient operation, it is recommended that the water heater is serviced annually.



Servicing must be performed by a qualified service agency or gas supplier

Inspection

- Visual inspection for general signs of corrosion
- Checking and adjusting the gas/air ratio
- Checking Flue Gas
- Carrying Out a Water Leak Test in Operation
- Carrying out a gas leak test in operation
- Checking Hot Water Temperature and Flow
- Checking Noise
- Checking venting systems
- Checking the remote controller

Maintenance

- Draining the water heater and cleaning the inlet water filter
- Cleaning the Return Filter
- Cleaning the intake air filter
- Flushing the heat exchanger
- Replacement of parts

8.3 Inspection Report

| Inspection Items | References | Date: | Date: |
|--|------------|-------|-------|
| Visual Inspection for General Signs of Corrosion | YES / NO | | |
| Checking and Adjusting the Gas/Air Ratio | YES / NO | | |
| Checking Flue Gas | YES / NO | | |
| Carrying Out a Water Leak Test in Operation | YES / NO | | |
| Carrying Out a Gas Leak Test in Operation | YES / NO | | |
| Checking Hot Water Temperature and Flow | YES / NO | | |
| Checking Noise | YES / NO | | |
| Checking Venting Systems | YES / NO | | |
| Checking the front panel. | YES / NO | | |

8.4 Maintenance Report

| Inspection Items | References | Date: | Date: |
|---|------------|-------|-------|
| Draining the Water Heater and Cleaning the Inlet Water Filter | YES / NO | | |
| Cleaning the Return Filter | YES / NO | | |
| Checking the Intake Air Filter | YES / NO | | |
| Flushing the Heat Exchanger | YES / NO | | |
| Replacement of Parts | | | |

9. Common Vent and Outdoor vent Cover Installing

9.1 Installing the Outdoor vent Cover

This kit must be installed by a qualified installer in accordance with these instructions and all applicable codes and requirements of the authorities having jurisdiction.

Keep this manual near the water heater for future reference whenever maintenance or service is required. The following safety symbols are used in this manual.

Read and follow all safety instructions in this manual precisely to avoid unsafe operating conditions, fire, explosion, property damage, personal injury, or death.

DANGER

Indicates an imminently hazardous situation which, if not avoided, could result in severe injury or death.

WARNING

Indicates a potentially hazardous situation which, if not avoided, could result in injury or death.

CAUTION

Indicates a potentially hazardous situation that, if not avoided, could result in property damage.

DANGER

If the information in these instructions is not followed exactly, a fire or explosion may result, causing property damage, personal injury, or death.

- Installation and service must be performed by a qualified installer, service agency or the gas supplier.
- The installation must conform with local codes or, in the absence of local codes, the National Fuel Gas Code, ANSI Z223.1/NFPA 54 and/or CSA B149.1, Natural Gas and Propane Installation Code.

WARNING

- The outdoor vent cover gets hot during operation. Install the heater in a location where the top of the vent cover kit cannot be reached by children and pets.
- Exhaust gas will be released through the outdoor vent cover kit. Exhaust gas is hot and contains carbon monoxide. The outdoor vent cover kit cannot be installed on a water heater mounted indoors. To prevent risk of fire and carbon monoxide poisoning, observe all clearances required in this manual.
- Do not place or store any combustible material within 5 feet of the appliance. Maintain specified clearance to combustibles on the wall where the appliance is installed and any adjacent walls or overhang. Observe all clearances required in this manual.
- The water in this appliance is cold and always remains cold except for the times when the burner is on. To prevent any damages from freezing, always drain the water heater.
- Damage to the water heater from freezing is not covered under the manufacturer's warranty.

Required Tool

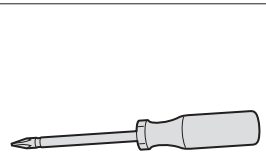

Phillips Screwdriver

Included Items

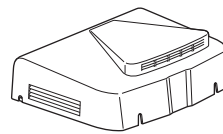

Outdoor Vent Cover

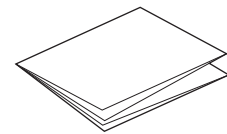

Installation Manual

9.2 Installing Procedure

1. Remove the two Phillips screws on the top front of water heater.

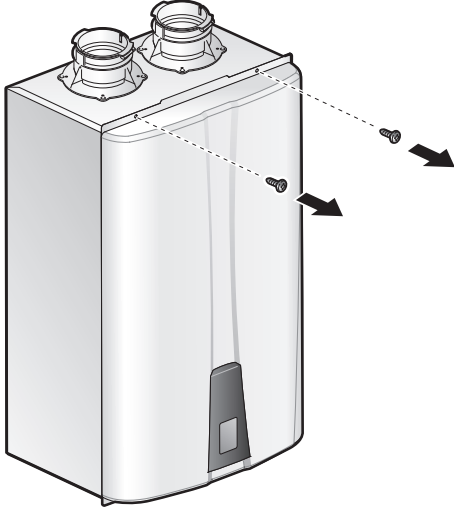

2. Position the outdoor vent cover on top of the water heater and securely press it into the intake and exhaust collars as illustrated.

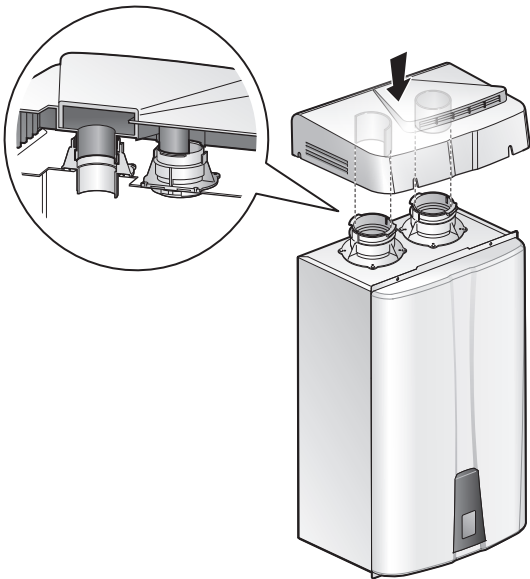

Make sure all the screw holes are aligned, and connectors for both vents are connected into place.

3. Tighten the screws on the front of the water heater.

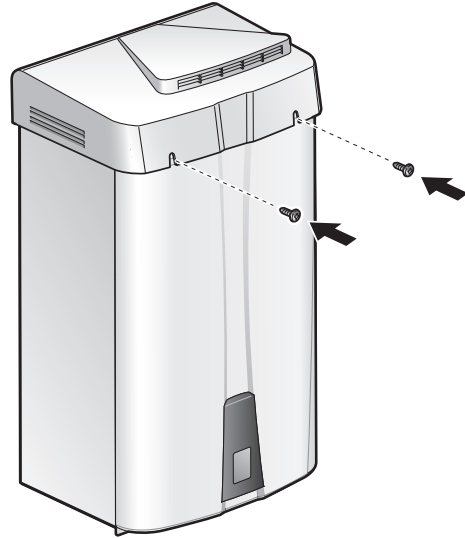

WARNING

Make sure the front cover of the water heater is securely reattached to prevent any damages to the water heater.



NOTE

Once the outdoor vent cover is installed, it does not need to be removed before removing the front cover of the water heater.

9.3 Choosing an Installation Location

When choosing an installation location, you must ensure that the location provides adequate clearance for the water heater, adequate venting and drainage options, and sufficient access to gas, water, and electrical supplies. Before proceeding, read the water heater installation manual.

- Choose an outside wall for the installation. Installation on a wall protected by an overhang above is recommended.
- Size the water and gas connections according to the instructions in the water heater installation manual. Use unions when connecting both water lines and the gas supply line to the heater.
- BS 5422 shows the Insulation tables for copper pipes complying with BS EN 1057 in normal exposure.

Install the water heater in an area that allows for service and maintenance access to utility connections, piping, filters, and traps. Based on the installation location, allow for the following minimum clearances from the water heater:

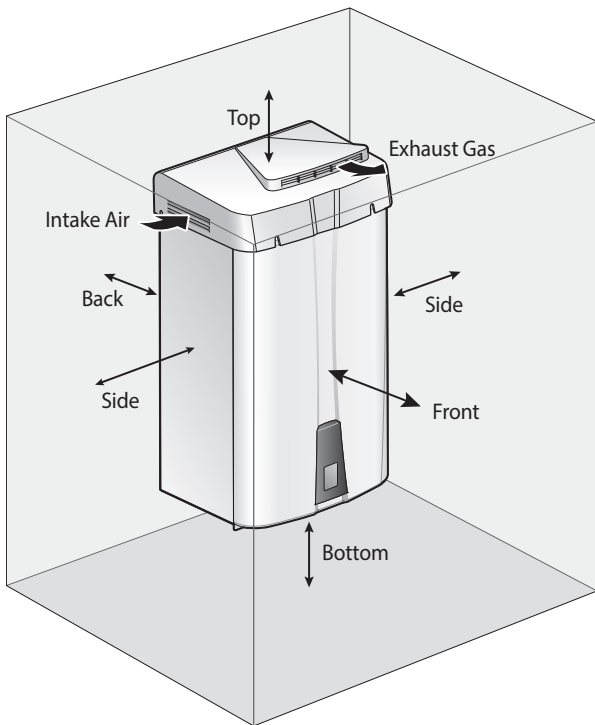
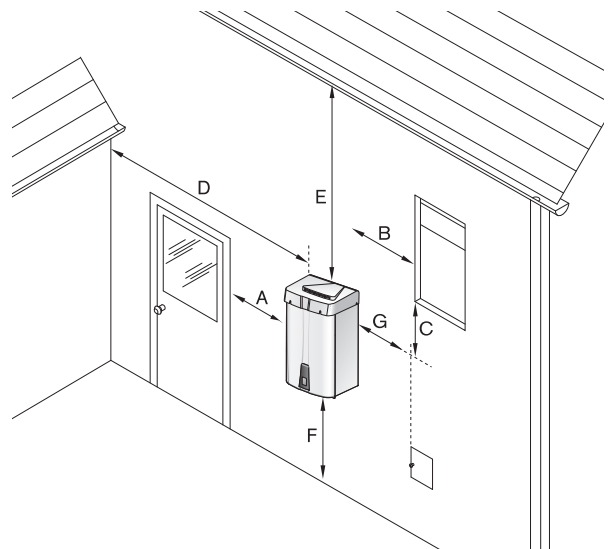

| References | Descriptions | Minimum distances |
|------------|--|-------------------|
| A | Directly below or adjacent to an opening; operable windows, doors and any fresh air openings | 48" (USA) |
| B | | |
| C | | |
| D | From any adjacent wall | 12" |
| E | Below a gutter, sanitary pipework, eaves or overhang | 36" |
| F | Above ground | 12" |
| G | From a gas meter or gas regulator | 36" |

| References | Minimum distances |
|------------|-------------------|
| Bottom | 12" |
| Back | 0.5" |
| Sides | 3" |
| Front | 24" |
| Top | 36" |

9.4 Mounting Water Heater

Navien water heaters come with a mounting bracket that is pre-drilled at 16 inches on center for easy installation on standard wall studs. If the strength of the wall is insufficient or if the framing is non-standard or uneven, reinforce the area before installing the water heater. Avoid installation on common walls as the unit will make some operational noises while it is running.

To mount the water heater to the wall:

1. Affix the bracket securely to the wall and ensure that it is level and that it can support the weight of the water heater.

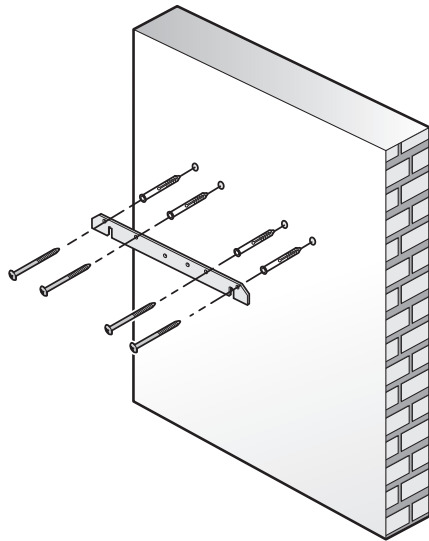

2. Align the grooves on the back of the water heater with the hooks on the mounting bracket and hang the water heater on the bracket.

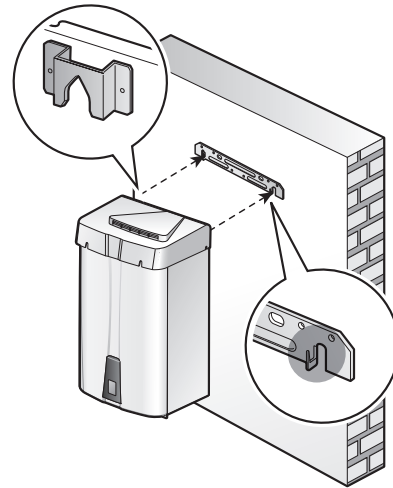

When mounted with the mounting bracket, the water heater will have a 5/8" (16mm) clearance from the back of the wall.

CAUTION

Do not mount the water heater to dry wall that has not been reinforced.

9.5 Ventilation Flow

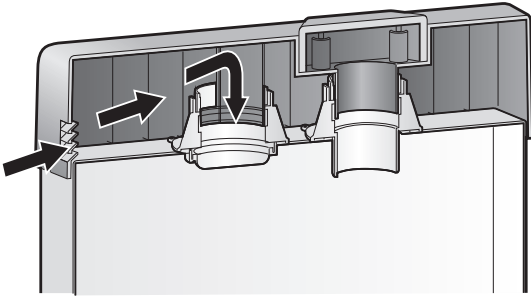
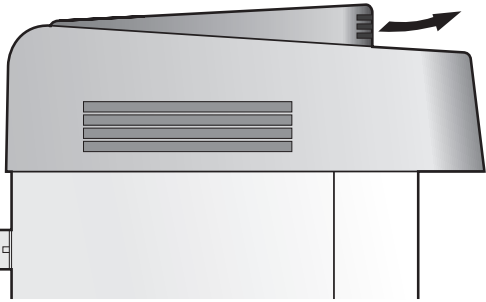
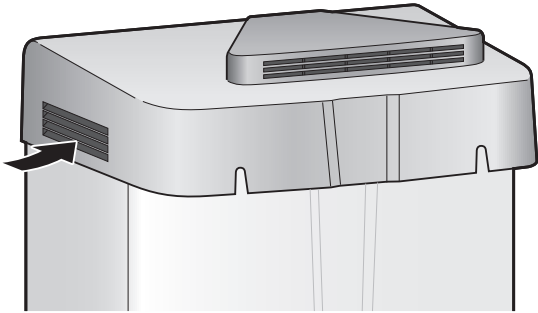

Intake Air Flow

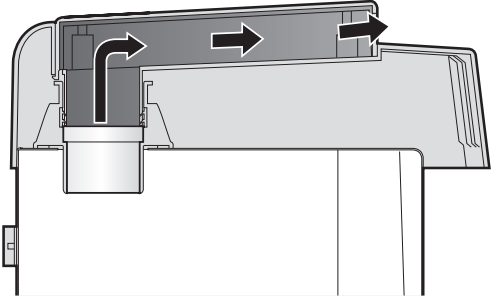

Exhaust Gas Flow

9.6 Common Venting

Model : NPE-24A, 24S, 32A, 32S

When cascading the water heaters with other Navien water heaters, you can install a common venting system. Do not use common venting if the water heater is used in a cascading system with other manufacturer's water heaters. Include a condensate drain in the main trunk as illustrated in the following examples.

- Venting the Exhaust Only (Non-Direct)

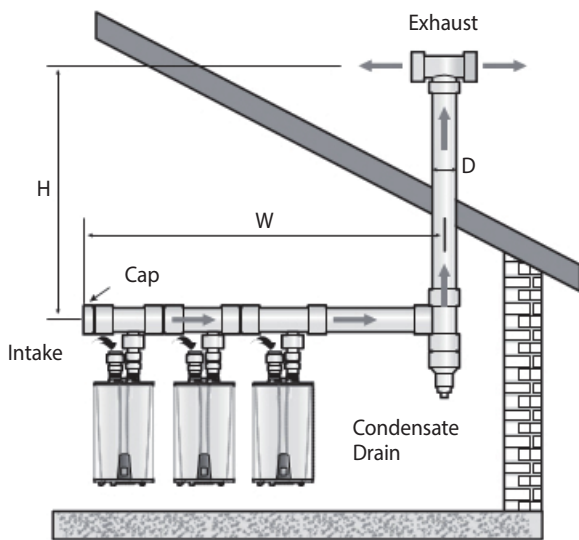

- Venting Intake and Exhaust to the Same Location

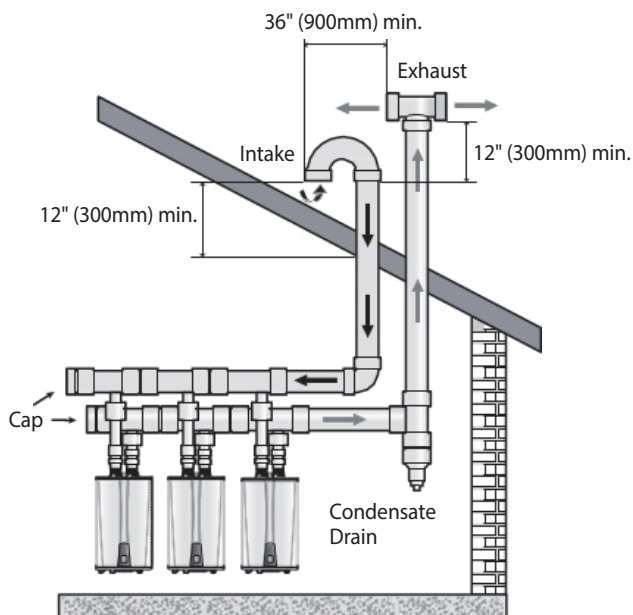

- Venting Intake and Exhaust to Different Locations

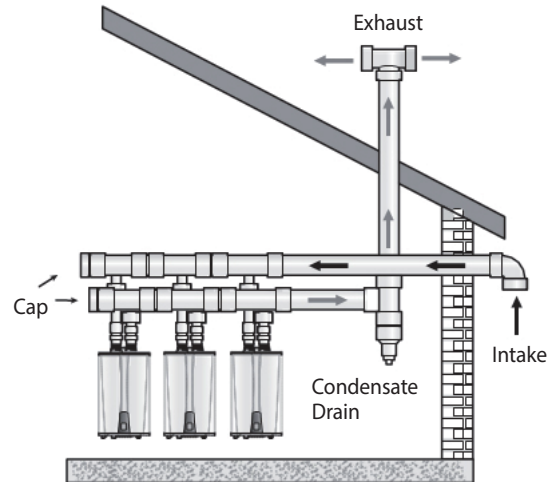

To determine the size of a common vent:

1. Add the BTU/H input ratings for each water heater in the cascading system to determine the total BTU/H rating.
2. Determine the total length (L) of the common vent, which consists of the horizontal width (W) and the vertical height (H): Total length (L) = W + H.

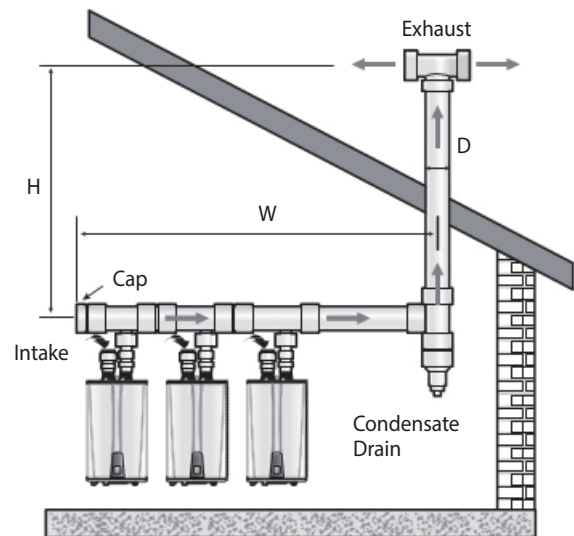

3. Refer to the common vent table that follows to determine the minimum length required for the common vent, based on the total BTU/H rating, and the diameter of the vent pipe.

NOTE

For each short radius elbow that will be used in the vent, add 8 feet (2.4 m) to the total length. For each long radius elbow that will be used in the vent, add 5 feet (1.5m) to the total length.

! CAUTION

- Regardless of the vent size listed in the table, the connection to the common vent must always be as large as the largest connector. If the largest connector and the recommended vent are the same size, use the next largest size for the vent.
- One short radius elbow = 8 feet, One long radius elbow = 5 feet

Total length (L) = W + H

| Required Load (Total kcal/h) | Model | | Total length (ft) | | | |
|---------------------------------|------------------------|------------------------|-------------------|----------|----------|----------|
| | NPE-24AWE NPE-24SWE | NPE-32AWE NPE-32SWE | D= 3" | D=4" | D=5" | D=6" |
| 75,600 | 2 | | 60(18m) | 100(30m) | 160(48m) | - |
| 83,100 | 1 | | 60(18m) | 100(30m) | 160(48m) | - |
| 90,700 | | 1 | 60(18m) | 100(30m) | 160(48m) | - |
| 100,300 | | 2 | 60(18m) | 100(30m) | 160(48m) | - |
| 136,000 | | | | 70(21m) | 110(33m) | 160(48m) |
| 140,800 | | 1 | | 70(21m) | 110(33m) | 160(48m) |
| 145,600 | | 2 | | 70(21m) | 110(33m) | 160(48m) |
| 150,400 | | 3 | | 70(21m) | 110(33m) | 160(48m) |
| | | | D=5" | D=6" | D=7" | D=8" |
| 186,100 | | 1 | 80(24m) | 120(37m) | - | - |
| 191,000 | | 2 | 80(24m) | 120(37m) | - | - |
| 195,800 | | 3 | 80(24m) | 120(37m) | - | - |
| 200,500 | | 4 | 80(24m) | 120(37m) | - | - |
| 251,000 | | 5 | 60(18m) | 90(27m) | 130(40m) | - |
| 300,900 | | 6 | - | 80(24m) | 100(30m) | 140(43m) |
| 351,000 | | 7 | | 70(21m) | 90(27m) | 120(36m) |
| | | | D=7" | D=8" | D=9" | D=10" |
| 401,100 | | 8 | 82(25m) | 107(33m) | 135(41m) | |
| 451,200 | | 9 | 73(22m) | 95(29m) | 120(37m) | 148(45m) |
| 501,300 | | 10 | 65(20m) | 85(26m) | 108(33m) | 133(41m) |
| 551,500 | | 11 | | 78(24m) | 98(30m) | 121(37m) |
| 601,600 | | 12 | | 71(22m) | 90(27m) | 111(34m) |
| | | | D=9" | D=10" | D=11" | D=12" |
| 651,800 | | 13 | 83(25m) | 103(31m) | 124(38m) | |
| 701,900 | | 14 | 77(23m) | 95(29m) | 115(35m) | 137(42m) |
| 752,000 | | 15 | 72(22m) | 89(27m) | 108(33m) | 128(39m) |
| 802,200 | | 16 | 68(21m) | 83(25m) | 101(31m) | 120(36m) |

10. Configuring the Water Heater

10.1 Configuring the NPE-24A/32A Water Heater

This section provides information required to properly configure the NPE-24A/32A water heater to setup and utilize the functions provided by the H2Air+ add-on controller.

10.1.1 Entering the Service Information Mode

Follow the instructions below to access the Service information mode.

1. At <Normal operation mode>, press the [Diagnostic] button once to access the service information screen.
2. If you press the [+] / [-] button, the value for the selected item is increased or decreased. Then, the adjusted value is displayed.
3. The currently-selected information data item is identified with an alphabet character prefix followed by 3 digits of the relevant data.
4. Press the [Reset] button once to return to <Normal operation mode>.



NOTE

If no buttons are pressed for 1 hour, then it automatically returns to the <Normal operation mode>.

| Item | Description | Display | |
|--|---|---------|---|
| (T) Outdoor temperature | Displays current outdoor temperature | | Outdoor reset OFF (Dip switch #1 'ON') |
| | | | Outdoor reset On (Dip switch #1 'OFF') eg.) 10 °C |
| (U) Heating temperature based on the outdoor temperature | Displays the heating temperature based on the current outdoor temperature | | Outdoor reset OFF (Dip switch #1 'ON') |
| | | | Outdoor reset On (Dip switch #1 'OFF') eg.) 49 °C |

10.1.2 Entering the R&D Information Menu

This section describes how to enter the R&D information mode to configure various parameters and control system functions.

Entering the R&D Information Menu

Follow the instructions below to enter the R&D information menu.

1. On the Front panel, press the Power button to turn off the water heater.
2. Enter the R&D information menu by pressing the Up (+) button three times, the Down (-) button three times, and then the Up (+) button four more times.
3. In the R&D information menu, use the Up (+) or Down (-) buttons to move to 2.PAR (Parameter information mode), and then press the Info button.



| No. | Mode | Display |
|-----|-----------------------|---------|
| 1 | Technical Information | |
| 2 | Parameter Information | |

4. To return to the previous menu (R&D information menu), press the [Reset] button once.

10.1.3 Parameter Table

The following table lists the parameters used to configure the water heater system functions.

| No. | Mode | Display |
|-----|------------------------------------|---------|
| 4 | Pump Exercise Operation Time | |
| 5 | Burn Delay Time | |
| 6 | Pump Post Purge Time | |
| 7 | Outdoor Low Temperature Set-point | |
| 8 | Outdoor High Temperature Set-point | |
| 9 | CH MIN Set-point | |

| No. | Mode | Display |
|-----|----------------------------------|---|
| 10 | CH MAX Set-point |  |
| 11 | 2-Stage T/S Output Heat-Capacity |  |

10.1.4 Configuring Water Heater Functions

This section describes the water heater functions and provides the information required to configure the parameters for the desired operation.

Pump Exercise Operation Time (P04)

The pump exercise function is designed to prevent the stagnation of hot water in the heating system.

The pump exercise function operates every 24 hours. Pump exercise operation time function sets the desired pump exercise operation time differently depending on the plumbing as well as environmental conditions.

With this option activated, the NPE-24A/32A water heater monitors the pump operation. When it detects that a pump has not been used for a specific period, it runs the pump for a set duration. If the flow rate is not detected while the pump is operating, the 'E438' error message is displayed.

To change the pump exercise operation time:

1. In the Parameter information time mode, use the Up (+) or Down (-) buttons to select P.04. Then, press the Info button to enter the Pump exercise operation time mode.
2. In the Pump exercise operation time mode, use the Up (+) or Down (-) buttons to change the value and press the Info button to set to the desired mode.

| Range | Description | Display |
|------------|--|---|
| 1-240(sec) | Sets the exercise operation time (default: 30 sec) |  |



NOTE



- If no buttons are pressed for 10 seconds or if the Info button is pressed, the current parameter value will be saved automatically.
- To return to the <PARAMETER INFORMATION MENU MODE>, press the [Reset] button once.
- If no buttons are pressed for five minutes, the display will automatically return to the <PARAMETER INFORMATION MENU MODE>.
- While the pump is exercising, the burner will not fire.

Burn Delay Time (P.05)

This function is used to set the burner delay time at an optimal value for the air handler application. If there is no burner delay time, the water heater might turn on or off once or twice during the air handler delay time.

To change the burner delay time:

1. In the Parameter information time mode, use the Up (+) or Down (-) buttons to select P.05. Then, press the Info button to enter the Burn delay time mode.
2. In the Burn delay time mode, use the Up (+) or Down (-) buttons to change the value and press the Info button to set to the desired mode.

| Range | Description | Display |
|-------------|--|---|
| 0 | Burn delay time unavailable |  |
| 1-120 (sec) | Sets the pump ON delay time when the heating is turned on (default: 30 sec). |  |



NOTE



- If no buttons are pressed for 10 seconds or if the Info button is pressed, the current parameter value will be saved automatically.
- To return to the <PARAMETER INFORMATION MENU MODE>, press the [Reset] button once.
- If no buttons are pressed for five minutes, the display will automatically return to the <PARAMETER INFORMATION MENU MODE>.

Pump Post Purge Time (P.06)

This function is used to set the post purge time after a combustion cycle is completed.

To change the pump post purge time:

1. In the Parameter information time mode, use the Up (+) or Down (-) buttons to select P.06. Then, press the Info button to enter the Pump post purge time mode.
2. In the Pump post purge time mode, use the Up (+) or Down (-) buttons to change the value and press the Info button to set to the desired mode.

| Range | Description | Display |
|-------------|---|---|
| 0 | Pump post purge time unavailable |  |
| 1-120 (sec) | Sets the pump post purge time when heating stops in a system (default: 30 sec). |  |



NOTE

- If no buttons are pressed for 10 seconds or if the Info button is pressed, the current parameter value will be saved automatically.
- To return to the <PARAMETER INFORMATION MENU MODE>, press the [Reset] button once.
- If no buttons are pressed for five minutes, the display will automatically return to the <PARAMETER INFORMATION MENU MODE>.

Outdoor Reset Control (P07–P10)

The Outdoor Reset Control feature can be used to enhance energy efficiency while maintaining optimal heating performance. Outdoor Reset Control automatically changes the space heating temperature setting based on the outdoor temperature and the current space heating system application (system load).

To achieve optimal heating performance, configure the following set-points: the Outdoor Low Temperature, the Outdoor High Temperature, the heating MIN and the heating MAX Set-point configuration must be based on the H2Air+ system characteristics and installation environment.

Refer to the following examples in the graph to configure the Outdoor Reset Control feature.

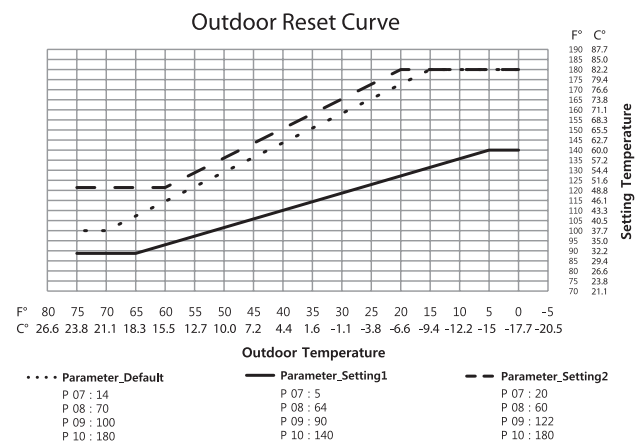

* The graph above is an example of a few possible outdoor reset parameter settings. For more information about settings, refer to the following information.

Outdoor Low Temperature Set-point (P.07)

To change the outdoor low temperature set-point:

1. In the Parameter information time mode, use the Up (+) or Down (-) buttons to select P.07. Then, press the Info button to enter the Outdoor low temperature set-point mode.
2. In the Outdoor low temperature set-point mode, use the Up (+) or Down (-) buttons to change the value and press the Info button to set to the desired mode.



NOTE

- If no buttons are pressed for 10 seconds or if the Info button is pressed, the current parameter value will be saved automatically.
- To return to the <PARAMETER INFORMATION MENU MODE>, press the [Reset] button once.
- If no buttons are pressed for five minutes, the display will automatically return to the <PARAMETER INFORMATION MENU MODE>.

Outdoor High Temperature Set-point (P.08)

To change the outdoor high temperature set-point:

1. In the Parameter information time mode, use the Up (+) or Down (-) buttons to select P.08. Then, press the Info button to enter the Outdoor high temperature set-point mode.
2. In the Outdoor high temperature set-point mode, use the Up (+) or Down (-) buttons to change the value and press the Info button to set to the desired mode.



NOTE

- If no buttons are pressed for 10 seconds or if the Info button is pressed, the current parameter value will be saved automatically.
- To return to the <PARAMETER INFORMATION MENU MODE>, press the [Reset] button once.
- If no buttons are pressed for five minutes, the display will automatically return to the <PARAMETER INFORMATION MENU MODE>.

Heating MIN Set-point (P.09)

To change the heating MIN set-point:

1. In the Parameter information time mode, use the Up (+) or Down (-) buttons to select P.09. Then, press the Info button to enter the Heating MIN set-point mode.
2. In the Heating MIN set-point mode, use the Up (+) or Down (-) buttons to change the value and press the Info button to set to the desired mode.



NOTE

- If no buttons are pressed for 10 seconds or if the Info button is pressed, the current parameter value will be saved automatically.
- To return to the <PARAMETER INFORMATION MENU MODE>, press the [Reset] button once.
- If no buttons are pressed for five minutes, the display will automatically return to the <PARAMETER INFORMATION MENU MODE>.

Heating MAX Set-point (P.10)

To change the heating MAX set-point:

1. In the Parameter information time mode, use the Up (+) or Down (-) buttons to select P.10. Then, press the Info button to enter the Heating MAX set-point mode.
2. In the Heating MAX set-point mode, use the Up (+) or Down (-) buttons to change the value and press the Info button to set to the desired mode.



NOTE

- If no buttons are pressed for 10 seconds or if the Info button is pressed, the current parameter value will be saved automatically.
- To return to the <PARAMETER INFORMATION MENU MODE>, press the [Reset] button once.
- If no buttons are pressed for five minutes, the display will automatically return to the <PARAMETER INFORMATION MENU MODE>.

2-Stage T/S Output Heat-Capacity (P.11)

Models with the 2-stage air handler control function (W1, W2) can use a 2-stage thermostat or can be automatically controlled by the H2Air+ controller (If the DIP switch # 3 is OFF).

When using the automatic 2-stage heating feature, the system will modulate between the 1-stage and 2-stage based on the set heat capacity parameter of the water heater. This heat capacity value can be adjusted based on the desired modulation point (default heat capacity is 25%)

To change the 2-stage T/S output heat-capacity:

1. In the Parameter information time mode, use the Up (+) or Down (-) buttons to select P.11. Then, press the Info button to enter 2-stage T/S output heat-capacity mode.
2. In the 2 stage T/S output heat-capacity mode, use the Up (+) or Down (-) buttons to change the value and press the Info button to set to the desired mode.

| Item | Description | Display |
|------------------------------------|---|---------|
| Min heat capacity – 100% (by 0.5%) | <ul style="list-style-type: none"> • Sets the standard modulating heat capacity value between 1-stage and 2-stage heating operation • 2-stage T/S OFF (DIP switch #3 'OFF') | |
| Unavailable | 2-stage T/S ON (DIP switch #3 'ON') | |



NOTE

- If no buttons are pressed for 10 seconds or if the Info button is pressed, the current parameter value will be saved automatically.
- To return to the <PARAMETER INFORMATION MENU MODE>, press the [Reset] button once.
- If no buttons are pressed for five minutes, the display will automatically return to the <PARAMETER INFORMATION MENU MODE>.

10.2 Maintenance

The Navien NPE-24A and NPE-32A water heaters that are used in the DHW/heating systems should be properly maintained and flushed on an annual basis. Please see the NPE Water Heater Service Manual for more details regarding annual servicing and maintenance.

10.3 Appendix

This section provides additional information to be considered when you design a hydronic system using an NPE-24A/32A water heater.

10.3.1 Pressure Drop Curve

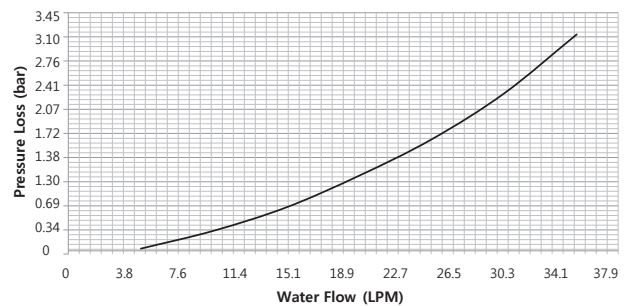

[NPE-24AWE/24SWE]

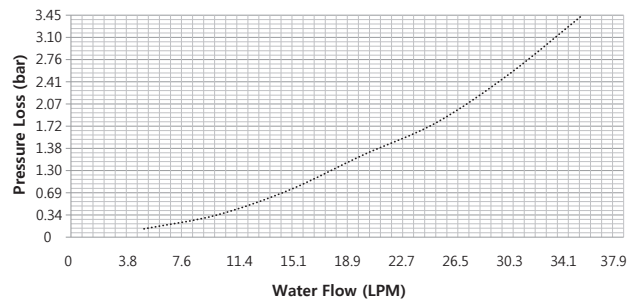

[NPE-32AWE/32SWE]

10.3.2 Outlet Flow Data

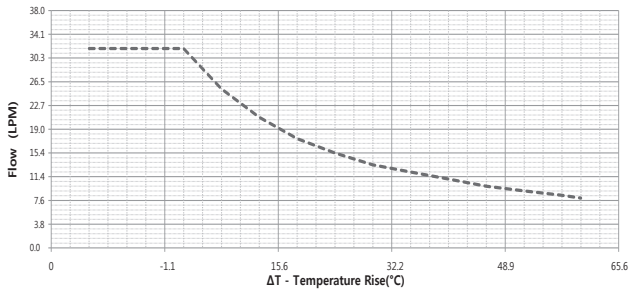

[NPE-24AWE]

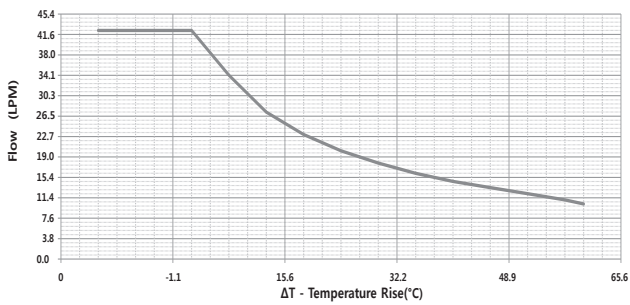

[NPE-32AWE]

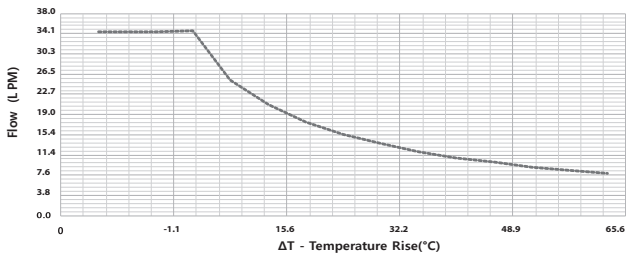

[NPE-24SWE]

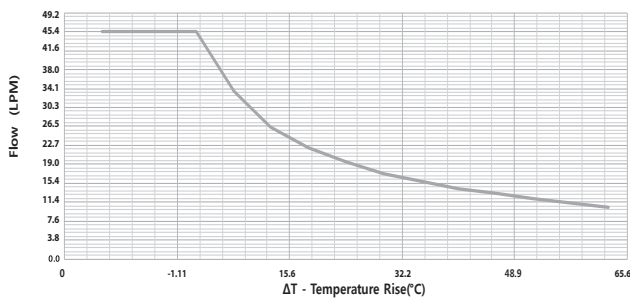

[NPE-32SWE]